

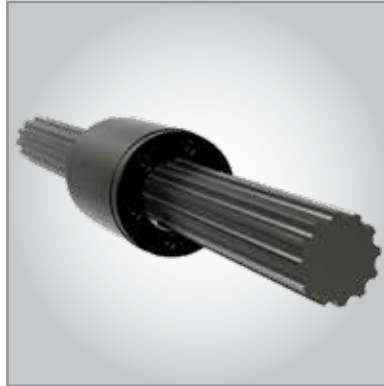

W O R M G E A R S C R E W J A C K S



Precision Ball Screws



Ball Splines



CC™ Cylinders



Worm Gear Screw Jacks

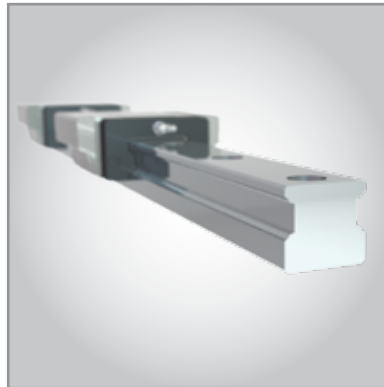

Profile Rails



Planetary Roller Screws

HISTORY

In 1969, Joseph H. Nook Jr. founded Nook Industries, Inc., intent on becoming a global supplier of Linear Motion products. Ball screws, both rolled and ground, were the cornerstone products in the early 1970's, putting Nook Industries, Inc. on the map as a successful business and a trusted company.

Through the years, Nook Industries, Inc. has served as a leading manufacturer of engineered products. From the first ball screws to the latest technologies, Nook Industries, Inc. strived to provide customers with high quality products and engineered solutions.

In 2021, Nook Industries, Inc. was acquired by Altra Industrial Motion Corp. and integrated into Thomson Industries, Inc. within the Automation & Specialty segment.

Companies around the world depend on the quality products provided by Nook/Thomson to ensure their success. Nook/Thomson provides a complete line of linear motion products, serving a wide range of market segments.

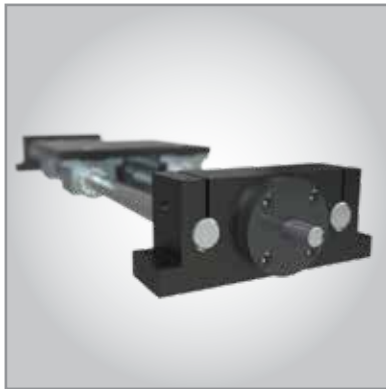

Linear Slides

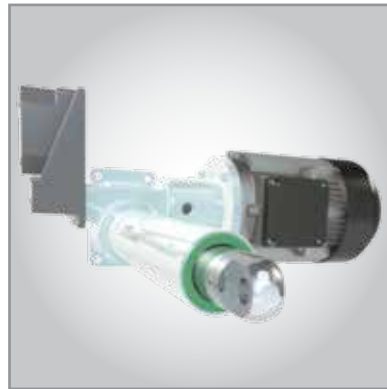

Electric Cylinders





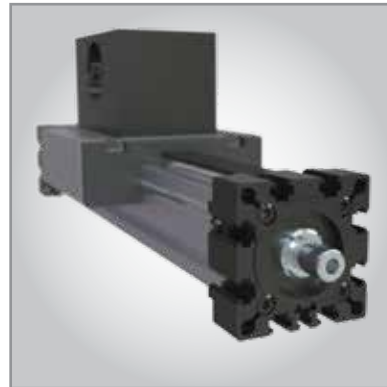











EZZE Mounts™



Modular Linear Actuators

MARKET SEGMENTS SERVED

-  Aerospace
-  Packaging
-  Automotive
-  Electronics
-  Transportation
-  Tire Manufacture
-  Entertainment
-  Semiconductor
-  Military and Defense
-  Factory Automation
-  Pulp & Paper
-  Steel
-  Chemical
-  Medical & Diagnostic

MISSION

Pairing traditional and proven design with the latest technology, Nook/Thomson manufactures products that customers value. The expansion of product lines and the development of application specific components and engineered systems have propelled Nook/Thomson to the forefront of the industry.

Nook/Thomson is committed to customer satisfaction and providing high-quality, high-value products that are delivered on time at a competitive price.

PARTNERS



QUALITY

HISTORY

Since 1969, Nook Industries, Inc. has relentlessly and continuously developed the capabilities and skills to deliver products of the highest quality. Knowledge of testing and design, coupled with this experience working with stringent customer requirements in aerospace, medical, energy and military applications has provided the background to be a reliable partner.

HIGH TECH QUALITY EXPERIENCE

When you select Nook/Thomson as a supplier, you can be assured that your product will be designed and tested to rigorous product planning. Pre-design activity includes understanding of customer requirements applied to predictive models, engineering calculations and linear modeling through prototype development, stereo-lithography samples of form, fit, and function that verify design criteria.

VALIDATION AND VERIFICATION

Through many years of rigorous development, Nook/Thomson has proven its designs and manufacturing processes against the most stringent standards and specifications. Design and process verification and validation tools are employed throughout the product life cycle.

CERTIFICATIONS

Nook Industries, Inc. is certified to ISO-9001-2008 Internationally Recognized Quality System. Nook/Thomson also serves many customers in the Aerospace and Medical device markets and has complied with those Quality System Requirements as well.



ITAR

Nook/Thomson is registered with the Department Of State For International Traffic In Arms Compliance.



INSPECTION CAPABILITY



Laser Lead Measurement - Precise lead error gauging is utilized to validate processes to conform to Nook/Thomson internal specifications and customer requirements.



Zeiss Roundness Measurement - Critical to quality, characteristics such as roundness are monitored throughout the screw manufacturing process.

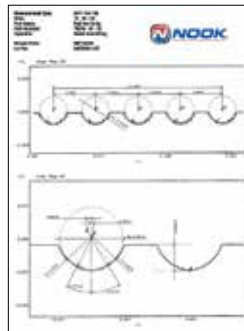
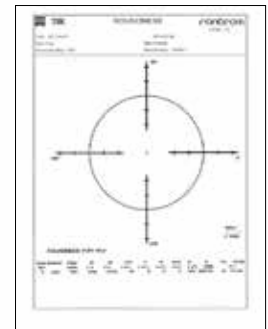

Zeiss Contour Readers - Prior to the start of any production run, thread form geometry is precisely measured to stringent engineering specifications.

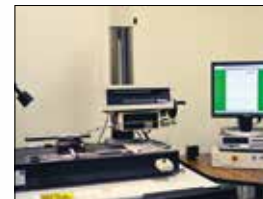

Metallurgical Lab - The metallurgical lab is capable of determining material composition from raw materials to final product. A micro hardness and case depth inspection is a routine check that validates the heat treat process.

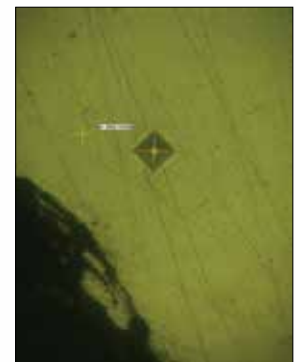

QUALITY TOOLS:

- Design for Six Sigma manufacturing
- D.O.E. (Design of Experiments)
- APQP (Advanced Product Quality Planning)
- DFMEA, PFEMA
- FEA (Finite Element Analysis)
- DVP&R (Design Verification Plan & Report)
- Reliability Testing
- Process validation to 21 CFR Part 82 (Medical Device)



DEVELOPED MANUFACTURING SYSTEMS

QUALITY SYSTEMS AND ACCREDITATIONS

SUPPLY CHAIN APPROVAL PROCESS

STATE OF THE ART MANAGEMENT SYSTEMS

APQP LAUNCH PROTOCOLS

SYSTEM AND PROCESS PROTOCOLS

ENGINEERING ANALYSIS AND PREDICTIVE TOOLS

CTQ/KPV ENGINEERING SPECIFICATION PROCESSES

RELIABILITY ENGINEERING AND TESTING

DVP&R AND TEST PLANNING

NOOK/THOMSON DESIGNED AND BUILT TEST MACHINES

CUSTOM ENGINEERED AND BUILT TEST INSTRUMENTATION

DESIGN AND TEST FOR FAULT TOLERANCE AND PROGNOSTICS

OVERLOAD/PROOF END OF LINE TESTING

CERTIFICATION TESTING

TESTING

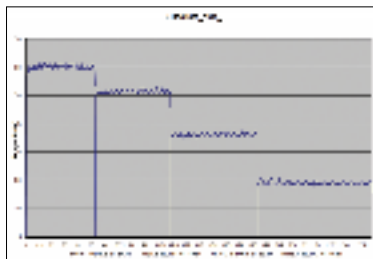

Efficiency Measurement - Nook/Thomson Engineering has designed test machines to measure and validate screw assembly efficiency.

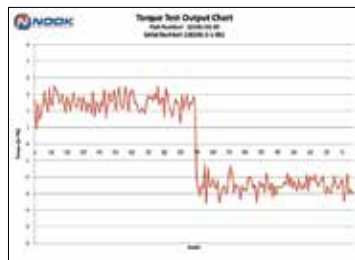

Torque Measurement - Preloaded ball screw assemblies are evaluated to determine compliance with engineering specifications utilizing a Dynamic Torque Testing Machine.



FUNCTIONAL TESTING

Nook/Thomson test systems and engineered testing processes perform analysis, verification, and solidification of life, durability, and performance. The functional testing defines operating limits in specifications and helps set defined targets in Product Launch Process and Assurance Plans.

The engineered testing provides predictive tools, generates data for prognostics, and validates performance wear models. Life tests help determine performance in multiple operating conditions as well. Nook/Thomson offers proof testing for customers developing new systems and actuators to help accelerate product release dates.



High Load Modular Test System
40,000 lb load - 100" CC



Convertible Test System
20,000 lb load - 100" CC



PRECISION SCREW JACK ACTUATORS



Nook/Thomson worm gear screw jacks are used in many military applications.



WORM GEAR SCREW JACKS

TECHNICAL INTRODUCTION	6-21
Jack Models.....	6-7
Jack Configurations	8-12
Definitions and Technical Data	13-14
Design Considerations	15-17
Application Examples.....	18-21
BALL SCREW JACKS	22-61
Ball Screw Jack Technical Information	24-31
Technical Data	32-61
MACHINE SCREW JACKS	62-97
Technical Information	64-69
Technical Data	70-97
STAINLESS STEEL JACKS	98-117
Technical Information	100-103
Technical Data	104-117
METRIC BALL SCREW JACKS	118-135
Technical Information	120-123
Technical Data	124-135
METRIC TRAPEZOIDAL SCREW JACKS	136-153
Technical Information	138-141
Technical Data	142-153
CUBIC JACKS	154-177
Technical Information	156-161
Technical Data	162-177
ACCESSORIES	178-207
INSTALLATION & MAINTENANCE	208

JACK MODELS

ActionJac™ Worm Gear Screw Jack systems are ruggedly designed and produced in standard models with load handling capacities from 1/4 ton to 100 tons. They may be used individually or in multiple arrangements. There are no “standard” travel lengths and each Worm Gear Screw Jack is built to specification.

The jack housings are made of ductile iron and proportioned to support the rated capacity of the unit. MJ, 1/4 ton, and 1/2 ton models have aluminum housings.

Each ActionJac™ Worm Gear Screw Jack incorporates an alloy steel worm which drives a high strength bronze worm gear (drive sleeve). The worm shaft is supported on anti-friction tapered roller bearings with external seals provided to prevent loss of lubrication (sealed radial bearings on the MJ, 1/4 , 1/2, and 1 ton units). The drive sleeve is supported on antifriction tapered roller or ball thrust bearings. Rotation of the drive sleeve causes the lifting screw to translate or rotate, depending upon jack configuration.

BALL SCREW JACKS

ActionJac™ Ball Screw Jacks use a ball screw and nut made from hardened alloy steel with hardened bearing balls carrying the load between nut and screw. This rolling action reduces friction between the nut and the screw permitting smooth and efficient movement of the load. Because of the greater efficiency and rolling action, the ball screw can operate at higher speeds or increased duty cycle when compared with the Machine Screw Jack. The addition of a high efficiency ball screw and nut reduces the required input torque to approximately one-third the torque required for the Machine Screw Jack.



MACHINE SCREW JACKS

ActionJac™ Machine Screw Jacks incorporate the use of an Acme Screw with a thread form of 2C. With the use of gear ratios of 20:1 or greater, the jacks can be considered to be self locking. Because the drive sleeve includes the acme thread form, it is possible to have an anti-backlash option.



STAINLESS STEEL SCREW JACKS



ActionJac™ Stainless Steel Machine Screw Jacks are ideal for use in demanding environments where corrosion resistance is required. All external components are manufactured from 300 Series Stainless Steel materials. These jacks use a stainless steel worm with a high strength bronze drive sleeve. Load capacities for Stainless Steel Machine Screw Jacks range from 1,300 to 23,000 pounds. For increased capacity, a 17-4PH hardened worm is available.

METRIC TRAPEZOIDAL SCREW JACKS



ActionJac™ Trapezoidal Screw Jacks utilize the same rugged design as ActionJac™ Machine Screw Jacks. These true metric jacks include a lift shaft with a special trapezoidal thread form. This thread form has been created to stay within ISO standards yet retains the centralizing feature of our 2C acme threads. These jacks can be supplied with IEC motor mounts.

METRIC BALL SCREW JACKS

With over twenty-five years of experience manufacturing precision worm gear screw jacks, Nook/Thomson has expanded the ActionJac™ offering to include metric models providing design engineers a globally accepted product. All the efficiency advantages that come with ball screw technology are available in ActionJac™ Metric Ball Screw Jacks. A full line of IEC motor mounts are available as well.



CUBIC JACKS

ActionJac™ Cubic Ball Screw and Machine Screw Jacks meet international Cubic Jack versatile mounting standards. Mounting versatility is further increased with the provision for trunnion mounting that is integral to the Cubic Jack housing. Housings are made from high quality, corrosion-resistant aluminum. Cubic Jacks are capable of directly mounting a wide array of motors and gear reducers. Available in true metric and inch execution.



JACK CONFIGURATIONS

TRANSLATING JACKS

A translating jack has a lifting shaft that moves through the gear box. A nut is integrated with the worm gear such that the worm gear and nut rotate together. When the lift shaft is held to prevent rotation, the lift shaft will move linearly through the gear box to move the load.



Upright Translating Ball Screw Jack



Upright Translating Machine Screw Jack



Inverted Translating Ball Screw Jack



Inverted Translating Machine Screw Jack



This printing press application utilizes two upright translating ball screw jacks to set the proper gauge on the feed rollers.

ROTATING JACKS

A rotating jack has a lift shaft that moves a nut as it turns. The lift shaft is fixed to the worm gear. This causes the load, which is attached to the travel nut, to move along the lift shaft.



Upright Rotating Ball Screw Jack

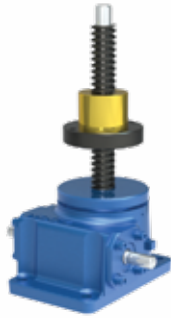

Upright Rotating Machine Screw Jack



Inverted Rotating Ball Screw Jack



Inverted Rotating Machine Screw Jack



In this automobile lift, the linear motion is provided by two inverted rotating ball screw jacks.



2D/3D CAD ONLINE

nookindustries.com

JACK CONFIGURATIONS (CONTINUED)

DOUBLE CLEVIS JACKS

Double Clevis Jacks are used when it is necessary to move a load through an arc, such as tracking antennas, hinged doors or air dampers. Machine Screw and Ball Screw Jacks from 1 ton to 15 ton capacities can be supplied with double clevis mounts. One clevis is mounted on the end of the lift shaft and the other clevis is welded to a heavy duty stem cover, which is welded to the housing. Double clevis designs are available with optional accessories such as boots, motor mounts, right-angle reducers, motors, encoders and rotary limit switches.

To check column strength limitations for each application, use the extended pin-to-pin dimension and the column strength chart on

pages 30 and 68.

NOTE: Mounting hardware for double clevis jacks should be specified as heat treated alloy steel clevis pins with at least 100,000 psi ultimate tensile strength.

Double clevis jacks used horizontally will have reduced column strength and life. For most horizontal applications, Nook/Thomson recommends the use of an Electric Cylinder (contact Nook/Thomson Engineering for more information).



Double Clevis
Ball Screw Jack



Double Clevis
Machine Screw Jack



In this solar panel application, the linear motion is provided by a double clevis machine screw jack.

KEYED JACKS

The lift shaft of a translating style jack must be attached to something which prevents the lift shaft from rotating. If it is not, the lift shaft (and the load) will turn and not translate. A feature can be added to a machine screw jack to prevent lift shaft rotation. This type of jack is referred to as a “keyed jack” and is available in upright and inverted models. A keyed jack has a keyway machined along the length of the lifting screw. A matching key is fastened to the cover of the jack which will eliminate lift shaft rotation. The keyway in the screw causes greater than normal wear on the internal drive sleeve

threads, somewhat reducing jack life.

Ball screw jacks can also be supplied with a device that prevents rotation of the lift shaft. Anti-rotation is accomplished by a square guide attached to the screw translating inside a square stem cover attached to the jack. The square stem tube is supplied with lube fittings.



Upright Keyed
 Ball Screw Jack



Upright Keyed
 Machine Screw Jack



Inverted Keyed
 Ball Screw Jack

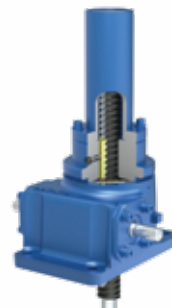

Inverted Keyed
 Machine Screw Jack



In this road barrier application, the linear motion is provided by an inverted keyed machine screw jack.



JACK CONFIGURATIONS (CONTINUED)

ANTI-BACKLASH JACKS

Anti-backlash Machine Screw Jacks are used wherever reversible load conditions require precision positioning control. Adjustable backlash Machine Screw Jack models are available to reduce backlash to approximately 0.003”.

An Anti-backlash Machine Screw Jack allows the lash between the drive sleeve thread and the lifting screw thread to be controlled by adjusting the top cover of the jack. The anti-backlash jack design has an upper drive sleeve and a lower drive sleeve. Adjustment of the cover changes the relative distance between the drive sleeves. This change in distance compensates for any lash. Because the drive sleeve is split, the life of an Anti-backlash Machine Screw Jack will be less.

Anti-backlash Machine Screw Jacks minimize backlash, but should not be used to completely eliminate backlash. While it may be desirable to totally eliminate backlash, the result would be a lock-up of lifting shaft and drive sleeve.

Ball Screw Jacks can be factory adjusted to reduce backlash by selecting bearing ball size in the ball nut. This selective fit technique can be used to achieve a lash between the ball nut and ball screw of 0.003” - 0.005”. Precision ball screws with preloaded ball nuts can be supplied to achieve zero lift shaft backlash.



Upright Anti-Backlash Machine Screw Jack



Inverted Anti-Backlash Machine Screw Jack



In this steel press application, the inverted translating anti-backlash jacks set the roller height with precision control.



DEFINITIONS AND TECHNICAL DATA

TRAVEL LENGTH

As a manufacturer of lead screws, Nook/Thomson stocks a wide selection of inch and metric ball, acme and trapezoid screws in long lengths. Jacks are not preassembled or stocked with standard length screws. Each jack is made to order based on travel length.

Nook/Thomson has the capability to manufacture long screws for special applications, limited only by the availability of raw materials. Rotating screw jacks may be assembled with a larger diameter lift screw for greater column strength. Jacks can be supplied with special pitch lift screws to change the jack operating speed.

TWIN LEAD SCREWS

Jacks can also be assembled with twin lead screws if required by the application. Contact the engineers at Nook/Thomson for availability.

TRAVEL VS. INPUT REVOLUTIONS

The number of turns of the worm required to move one inch is a function of the worm gear ratio and the lead of the screw. The charts at the front of each section give the number of "turns of worm for 1" raise" for each jack. The motor rpm divided by this number is the linear speed of the jack lift shaft or travel nut. Conversely, the desired travel rate multiplied by the "turns of worm for 1" raise" equals the input rpm required.

LEAD ACCURACY AND MATCHED LEAD

Lead accuracy is the difference between the actual distance traveled versus the theoretical distance traveled based on lead. For example: A screw with a 0.5 inch lead and ± 0.004 " per foot lead

accuracy rotated 24 times theoretically moves the nut 12 inches. $24 \text{ Revolutions} \times .500 \text{ inches per revolution} = 12.000 \text{ inches of travel}$. With a Lead accuracy of ± 0.004 " per foot, actual travel could be from 11.996 to 12.004 inches.

The rolled thread ball screw, as employed in ActionJac™ products, is held within ± 0.004 " per foot lead error. The rolled acme thread screws used in our machine screw jacks have a typical lead accuracy of ± 0.004 " per foot.

When multiple jacks are used to move a load with precise synchronicity, lift shafts of similar lead accuracy can be factory selected and supplied as sets. Consult factory for matched lead set tolerances.

INPUT TORQUE

The input torque is the rotary force required at the input of the jack to generate an output force at the lift shaft. The product specification pages show the torque necessary to raise one pound. This number multiplied by the load is the required input torque.

Due to static friction, starting or "breakaway" torque can be as much as two to three times running torque. If the load is moved horizontally, the force required to move the load will be lessened in proportion to the coefficient of friction of the surface along which the load is moved. In addition, the force needed to start, stop and hold the load (inertia loading) is provided by the jack. Jack sizing should consider all these forces. If an application calls for several jacks to be driven together in series, the first jack should be limited to three times the rated Maximum Input Torque, as listed in the Jack Selection chart for the particular selected jack. For multiple high lead ball screw jacks or belt/chain driven jacks contact Nook/Thomson for



Nook/Thomson worm gear screw jacks are used widely in the locomotive industry.

DEFINITIONS AND TECHNICAL DATA (CONTINUED)

allowable input torque values. Multiple jacks driven in a series may require operation at reduced load.

TARE DRAG TORQUE

The gear box components (bearings, seals and grease) in a jack add "tare drag." The product specification pages show the tare drag torque. When loading ActionJac™ Worm Gear Screw Jacks with loads less than 25% of their rated capacity, tare drag torque needs to be added to the torque requirement.

INPUT SPEED

ActionJac™ Worm Gear Screw Jacks are rated for up to 3,000 rpm input speed, provided horsepower and temperature ratings are not exceeded. Contact Nook/Thomson engineers if higher input speeds are required.

DUTY CYCLE

Duty cycle is the ratio of run time to total cycle time. Some of the mechanical energy input to a worm gear screw jack is converted into heat caused by friction. The duty cycle is limited by the ability of the worm gear screw jack to dissipate heat. An increase in temperature can affect the properties of some components resulting in accelerated wear, damage and possible unexpected failure.

Maximum allowable horsepower ratings (see product specification pages) are based on intermittent operation. The approximate allowable duty cycles are: Ball Screw Jacks= 35% Machine Screw Jacks= 25%

SELF-LOCKING AND BRAKES

Self-locking occurs when system efficiencies are low enough that the force on the lifting shaft cannot cause the drive system to reverse direction. Machine Screw Jacks having gear ratios between 20:1 and 32:1, can be considered self-locking. However, vibration, wear, temperature, or lubrication characteristics may cause any worm screw jack to backdrive and should be considered. All other ratios will require a brake to prevent backdriving. All Ball Screw Jacks can backdrive and require some means of holding the load, such as a brake on the motor. The product specification pages show holding torque values. Holding torque represents the amount of input torque required to restrain the load.

In addition to back driving, system inertia usually results in some over travel when the motor is switched off. The inertia of the system should be considered when determining the brake size required to stop a dynamic load.

TEMPERATURE

All ActionJac™ Worm Gear Screw Jacks are suitable for operation within the specified limits provided that the housing temperature is not lower than -20°F or higher than +200°F. Factory supplied grease in standard units will operate in this range. For higher or lower operating temperature ranges contact Nook/Thomson.

Housing temperature should be monitored and kept below 200°F maximum. Continuous or heavy duty operation is possible by derating the jack capacity, external cooling of the unit or through the use of a recirculating lubrication system.



Nook/Thomson worm gear screw jacks are used widely in sawmills.

DESIGN CONSIDERATIONS

TRAVEL STOPS

Travel stops are not standard. A limit switch and a brake should be used to stop the motor. Mechanical stops can cause damage to the jacks because most electric motors will deliver stall torques much higher than their rated torques and motor inertia can cause severe shock loads. For hand operation, mechanical stops can be provided.

BALL SCREW VS. MACHINE SCREW JACK

The decision to use a ball screw jack or a machine screw jack is based on the application. For many applications, a ball screw model is the best choice. Ball screw jacks are more efficient and therefore require less power than a machine screw jack in the same application.

For low duty cycle applications, for hand-operated applications, or if backdriving is not acceptable consider a machine screw jack.

ActionJac™ Ball Screw Jacks are preferred for:

- Long travel lengths
- Long, predictable life
- High duty cycles
- Oscillating motion

ActionJac™ Machine Screw Jacks are preferred for:

- Resistance to backdriving
- Vibration environments
- Manual operation
- High static loads

JACK SIZING CONSIDERATIONS

Jacks are limited by multiple constraints: load capacity, duty cycle, horsepower, column strength, critical speed, type of guidance, brakemotor size, and ball screw life. To size a screw jack for these constraints, application information must be collected.

LOAD CAPACITY

The load capacity of the jack is limited by the physical constraints of its components (drive sleeve, lift shaft, bearings, etc.). All anticipated loads should be within the rated capacity of the jack. Loads on the jack in most applications include: static loads, dynamic or moving loads, cutting forces or other reaction forces and acceleration/deceleration loads.

For shock loads, the peak load must not exceed the rated capacity of the jack, and an appropriate design factor should be applied that is commensurate with the severity of the shock.

For accidental overloads not anticipated in the design of the system, jacks can sustain the following overload conditions without damage: 10% for dynamic loads, 30% for static loads.

Total Load - The total load includes static loads, dynamic loads and inertia loads from acceleration and deceleration. Also consider reaction forces received from the load such as drilling or cutting forces when using a jack to move a machine tool.

For multiple jack systems, load distribution should be considered. System stiffness, center of gravity, drive shaft windup and lead variation in the lift shafts may result in unequal load distribution. Jacks of varying capacity with equal “turns of worm for 1” travel” may be used to accommodate unequal loading.

Number of Jacks - The number of jacks used depends on physical size and design of the equipment. Stiffness of the equipment structure and guide system will determine the appropriate number of jacks required. Fewer jacks are easier to drive, align and synchronize.

GEARBOX EFFICIENCY

The gearbox efficiency is as follows;

- 5:1 - 10 2/3:1 = 60% to 65%
- 20:1 - 32:1 = 45% to 50%

DUTY CYCLE

Cycle Time – Total time the jack is operating in one complete cycle

Duty Cycle – Percentage of time on versus total time.

Verify the duty cycle for the selected jack. Recommended duty cycles at max horsepower are:

- Ball screw jacks = 35% (65% time off)
- Machine screw jacks = 25% (75% time off)

Duty cycle is based on standard ambient temperature, with 1 minute on 2 minute off cycles. The ability of the jack to dissipate the heat that builds during operation determines duty cycle. Anything that reduces the amount of heat generated or increases heat dissipation will allow higher duty cycles. Jacks may be limited by maximum temperature (200°F) and not duty cycle. Contact Nook/Thomson for assistance with these applications.

HORSEPOWER RATINGS

The horsepower limit of the jack is a result of the ability to dissipate the heat generated from the inefficiencies of its components. Maximum horsepower ratings are based on intermittent operation. Horsepower is calculated by using the following formula:

$$\text{Horsepower per jack} = \frac{\text{Torque to raise one pound} \times \text{Number of pounds to be raised} \times \text{input rpm}}{63,025}$$

The product specification pages show the “torque to raise one pound” value for each jack. Add tare drag torque if operating under 25% rated load.

Horsepower values are influenced by many application specific variables including mounting, environment, duty cycle and lubrication. The best way to determine whether performance is within horsepower limits is to measure the jack temperature. The temperature of the housing near the worm must not exceed 200°F.

DESIGN CONSIDERATIONS (CONTINUED)

For multiple jack arrangements, total horsepower required depends on horsepower per jack, number of jacks, the efficiency of the gear box(es) and the efficiency of the arrangement.

Arrangement efficiency –

- Two jacks = 95%
- Three jacks = 90%
- Four jacks = 85%
- Six to eight jacks = 80%

The efficiency of each miter gearbox is 90%. Therefore, motor horsepower requirement for the arrangement:

$$\text{Horsepower Arrangement} = \frac{\text{HP per jack} \times \text{Number of jacks}}{\text{Arrangement Efficiency} \times (\text{Gearbox Efficiency})^N}$$

where N = Number of gearboxes.

Do not exceed the maximum allowable input horsepower for a jack. Many models cannot lift the full rated load at 1,800 rpm.

If the horsepower required exceeds the maximum value for the jack selected, several solutions are possible.

- Use a larger jack model to increase the maximum allowable horsepower.
- Use a Ball Screw Jack to reduce the power required to do the same work.
- Operate at a lower input speed.
- Use a right angle reducer to bring the power requirement within acceptable limits.

When utilizing multiple jack arrangements, the input torque to the first jack must be considered. It is recommended that the number of jacks driven through a single jack input be limited to a maximum of three jacks. Consult Nook/Thomson Application Engineers for arrangements where more than three jacks will be driven through a single jack input.

COLUMN STRENGTH

Column strength is the ability of the lift shaft to hold compressive loads without buckling. With longer screw lengths, column strength can be substantially lower than nominal jack capacity.

If the lift shaft is in tension only, the screw jack travel is limited by the available screw material or by the critical speed of the screw. Refer to the acme screw and ball screw technical sections for critical speed limitations. If there is any possibility for the lift shaft to go into compression, the application should be sized for sufficient column strength.

Charts are provided in each section to determine the required jack size in applications where the lift shaft is loaded in compression. To use the charts (pages 30, 68, 102, 122, 140, 158, and 159), find

a point at which the maximum length “L” intersects the maximum load. Be sure the jack selected is above and to the right of that point.

Maximum Length – The maximum length includes travel, housing length, starting/stopping distance, extra length for boots and length to accommodate attachment of the load.

If column strength is exceeded for the jack selected, consider the following options:

- Change the jack configuration to put the lift shaft in tension
- Increase size of jack.
- Add a bearing mount (like the EZZE-MOUNT™) for rotating jacks.
- Change the lift shaft mounting condition (e.g. from clevis to top plate).

CAUTION: Chart does not include a design factor.

The charts assume proper jack alignment with no bending loads on the screw. Effects from side loading are not included in this chart. Jacks operating horizontally with long lift shafts can experience bending from the weight of the screw.

CRITICAL SPEED

The speed that excites the natural frequency of the screw is referred to as the critical speed. Resonance at the natural frequency of the screw will occur regardless of the screw orientation or configurations of the jack (vertical, horizontal, translating, rotating, etc.). The critical speed will vary with the diameter, unsupported length, end fixity and rpm of the screw. Since critical speed can also be affected by the shaft straightness and assembly alignment, it is recommended that the maximum speed be limited to 80% of the calculated critical speed.

Because of the nature of most screw jack applications, critical speed is often overlooked. However, with longer travels, critical speed should be a major factor in determining the appropriate size jack. Refer to Nook/Thomson Precision Screw Assemblies Design Guide to best determine the appropriate critical speed for a particular jack selection.

Travel Rate – Establishing a travel rate allows for evaluation of critical speed and horsepower limits. Acceleration/deceleration time needs to be considered when determining maximum required travel rate.

TYPE OF GUIDANCE

Linear motion systems require both thrust and guidance. Jacks are designed to provide thrust only and provide insufficient guidance support. The guidance system must be designed to absorb all loads other than thrust.

Nook/Thomson can provide either hardened ground round shafting or square profile rail to support and guide linear motion systems.

BRAKEMOTOR SIZING

Safety is the most important consideration. A brake motor is recommended for all ActionJac™ products where there is a possibility of injury.

Only 20:1 or greater ratio Machine Screw Jacks can be considered self-locking in the absence of vibration.

The horsepower requirements determine the size of the motor. Upon selecting a brake motor, verify that the standard brake has sufficient torque to both hold the load and stop the load.

CAUTION: High lead ball screw jacks may require larger nonstandard brakes to stop the load. An appropriately sized brake will insure against excessive “drift” when stopping for both the Ball Screw and Machine Screw Jacks.

BALL SCREW LIFE

A major benefit of the use of ball screw jacks is the ability to predict the theoretical life of the ball screw.

Ball screw life charts are located at the beginning of each ball screw jack section. (pages 28 -29, 121, and 160)

FINISHES

GEAR BOX	HOUSING	FINISH
1/2 ton, MJ, 1 ton	Aluminum	Industrial Enamel Paint
2 ton - 100 ton	Ductal Cast Iron	Industrial Enamel Paint
SS Jacks	300 Series Casting	Unpainted
Cubic Jacks	Aluminum	Clear Anodize

Per customer request, we can apply epoxy paint or MIL specification primers and paints or paint to other special requirements.

REQUIRED APPLICATION DATA

Load

- Total Maximum Thrust Load on Jacks
- Total Maximum Thrust Load on any one Jack
- Number of Jacks

Travel

- Inches
- Orientation (vertical, horizontal, arc, diagonal, etc.)

Travel Rate

- Optimal Speed
- Minimal Acceptable Speed
- Maximum Acceptable Speed

Duty Cycle

- Distance Per Cycle
- Number of cycles per time period
- Maximum Distance Traveled in any Year
- Life Desired

Configuration

- Tension, Compression, or both
- Driven by Hand, Motor, or Other
- Translating, Rotating, or Double Clevis

Arrangement

- Arrangement Type, (H, T, U, Inline)
- Arrangement Dimensions (X, Y₁, Y₂, etc.)

For dimension information, please refer to the guides online at www.nookindustries.com.



Nook/Thomson worm gear screw jacks are used widely in tire manufacturing.

APPLICATION EXAMPLES

H ARRANGEMENT

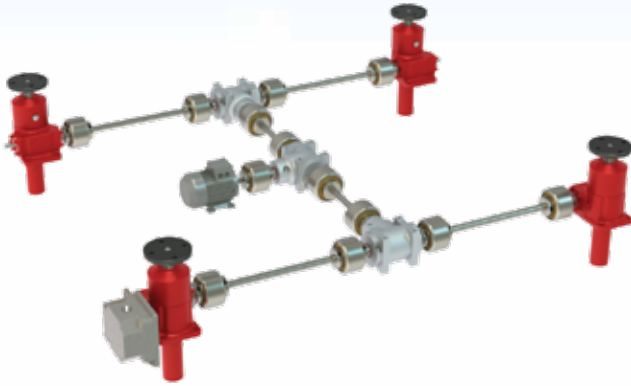

A manufacturer of steel frames used in the commercial dairy industry is building a material lift which contains a stack of prefabricated frames. The material lift will index up as each frame is removed by an automated grip from the top of the stack. The jack will index up 1" in 2 seconds every 30 seconds. After the last frame is removed, the jacks will fully retract to the collapsed position in 6 seconds waiting for the next load of frames. Complete cycle time is 10 minutes running 6 hours per day, 5 days per week. The design calls for a four jack arrangement lifting from underneath the lifting stage, driven by a single motor.

SPECIFICATIONS

- When fully loaded with frames the total weight is 16,800 lbs.
- When fully extended the total load is less than 5,000 lbs.
- The load will be in compression.
- Total travel: 6 inches
- Desired design life is one year.

ANALYSIS

Configuration: Due to frequent cycles and design life, the use of a ball screw jack would be best suited for this application. Using upright translating jacks will allow the jacks to be located under the material lift and not create any obstruction with the loading and unloading of the prefabricated frames.

Column Strength: The jacks will be fully loaded in the retracted position and be unloaded as they extended. Considering the worst case scenario with the full load at the full extended position, the load will be 16,800 lbs lifted by four jacks, and extended to 6" of travel. When considering column strength, the 2.5-BSJ-U jack can be used.



Speed and Horsepower: The extension travel rate of 1" in 2 seconds is 30"/min. The retraction travel rate of 6" in 6 seconds equates to 60"/min. This would require using the 6:1 gear ratio when using a 1750 rpm AC motor during retraction and 720 rpm during extension. Using the horsepower formulas on page 15 the total horsepower need when fully loaded is 3.0 HP with a dual speed 1750/800 AC motor.

$$HP_{\text{per jack}} = \frac{.0102 \text{ in-lb} \times 4,200 \text{ lb} \times 720 \text{ rpm}}{63,025} = .489 \text{ hp / jack (during extension)}$$

$$HP_{\text{arrangement}} = \frac{.489 \text{ hp per jack} \times 4 \text{ jacks}}{.85 \times (.9)^3} = 2.87 \text{ total hp (during extension)}$$

Line Shafting: The longest center to center distance between any jack and gearbox is 36 inches, leaving a shaft length of 29 inches. Using the formula on page 193 based on Torsional Twist, the proper Line Shafting to use would be the LJ-12.

$$N_{\text{Speed}} = .6192 \times \left(\frac{\pi}{29 \text{ in}}\right)^2 \times 5.851 \times 10^5 = 4,252 \text{ rpm}$$

$$N_{\text{Twist}} = 42.84 \text{ in-lb} \times \left(\frac{29 \text{ in}}{6,250}\right) = .199^\circ$$

Life: Based on the indicated cycle rate the total number of cycles over three years is 9,360 cycles. Considering the worst case scenario with the full load to the full extended position, then unloaded for the retraction, the loaded travel inches is just over 56,160 inches. When considering the life expectancy chart on pages 28-29, the 2.5-BSJ-U jack can be used.

SELECTION

Reference Number: From page 31, create reference numbers for the following: four 2.5 ton ball screw jacks, inverted rotating configuration, 6:1 worm gear ration, top plate, 6 inches of travel. One jacks to have a 2 circuit limit switch.

Jacks:

- (3) 2.5-BSJ-U 6:1/SSE-1/SSE-2/FP/6/S
- (1) 2.5-BSJ-U 6:1/2CA-3C/SSE-2/FP/6/S

Gearboxes:

- (2) GB210S Type E
- (1) GB210S Type D

Shafting:

- (4) LJ-12 29" OAL
- (2) LT-12 14" OAL

Couplings:

- (4) P-2200-185 (1/2 - 3/4)
- (8) P-2200-178 (3/4 - 3/4)

Motor:

3 HP AC Motor capable of a dual speed 1750/800

U ARRANGEMENT

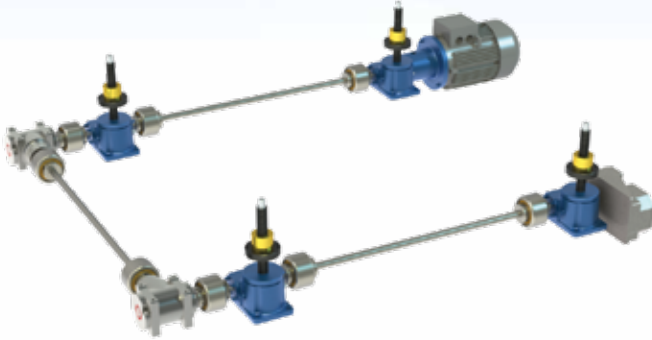

A leading cookie manufacturer is adding a new product that requires a greater distance to the top heating element of their conveyor oven. The oven originally only had a static-top heating element and with this new order, it needs to be adjustable up to 14 inches. The top heating element weighs 5,000 lb. The manufacturer anticipates only making adjustments to the height once or twice a month.

SPECIFICATIONS

- Single motor and drive.
- Food grade grease.
- The load will be in compression.
- Total travel 14 inches
- The actuators and power train must be located outside of the oven frame.
- Travel Rate negligible as long as the total travel can be reached in less than 60 seconds.
- 2 x safety factor

ANALYSIS

Configuration: Due to infrequent cycles, the use of a machine screw jack would be best suited for this application. Using upright rotating jacks will allow the jacks to be easily retrofitted to the existing oven with minimal modifications.

Column Strength: The jacks will be fully loaded in both the retracted and extended position. Because of the retrofit condition, it is not possible to have a support bearing on the lift shaft. Using mounting condition A on the Column Strength Chart located on page 68 and the manufacturer's safety requirements, the 10 ton jack was selected.

Speed and Horsepower: Using a standard 1750 AC Motor and the 24:1 gear ratio, full travel would be reached in 36 seconds. Using the horsepower formulas on page 15 a 5 HP AC motor running at 1750 rpm will be adequate for the requirements.

$$HP_{\text{per jack}} = \frac{.0192 \text{ in-lb} \times 1,250 \text{ lb} \times 1,750 \text{ rpm}}{63,025} = .66 \text{ hp / jack}$$

$$HP_{\text{arrangement}} = \frac{.66 \text{ hp per jack} \times 4 \text{ jacks}}{.85 \times (.9)^2} = 3.83 \text{ total hp}$$

Line Shafting: The longest center to center distance between any

two jacks is 79 inches, leaving a shaft length of 72 inches. Using the formula on page 193, based on Critical Speed, the proper Line Shafting to use would be the LJT-50

$$N_{\text{Speed}} = .6192 \times \left(\frac{\pi}{72 \text{ in}}\right)^2 \times 1.907 \times 10^6 = 2,248 \text{ rpm}$$

$$N_{\text{Twist}} = 96 \text{ in-lb} \times \left(\frac{72 \text{ in}}{25,000}\right) = .28^\circ$$

SELECTION

Reference Number: From page 69, create reference numbers for the following: four 10 ton machine jacks, upright rotating configuration, 24:1 worm gear ratio, 21 inches "L" dimension. One jack to have a 56C motor mount and a 5 HP brake motor, and one jack to have a 2 circuit limit switch.

Jacks:



(2) 10-MSJ-UR 24:1/SSE-1/SSE-2/FA/21/M

(1) 10-MSJ-UR 24:1/SSE-1/50BT-2/FA/21/M

(1) 10-MSJ-UR 24:1/SSE-1/2CA-8/FA/21/M

M=Food grade grease

Gearboxes:

(1) GB15 Type G

(1) GB15 Type F

Shafting:

(2) LJT-50 72" OAL

(1) LTJ-50 36" OAL

Couplings:

(4) P-2200-XX (1" - 22mm)

(2) P-2200-177 (1" - 1")

Motor:

5 HP AC Motor 1750rpm

APPLICATION EXAMPLES

T ARRANGEMENT

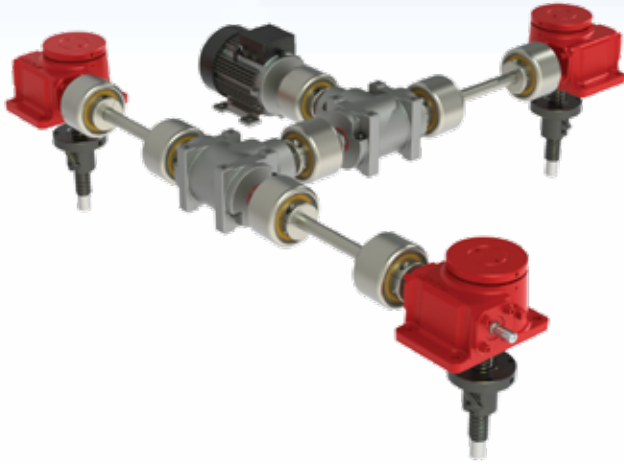

A manufacturer is looking to periodically raise and lower a cylindrical mixer eight inches during the mixing cycle to allow product testing to insure product quality and consistency. The cylinder weighs 1,700 lbs and is mounting on a movable cart allowing for the final product to be moved to a dispensing station. The customer wants a 4 times safety factor with respect to capacity.

SPECIFICATIONS

- Single motor and drive
- The load will be in tension.
- Total travel 8 inches
- 4 times safety factor
- 8 inches in 5 seconds

ANALYSIS

Configuration: To minimize the size of the motor drive, a Ball Screw jack will be used. Based on the mounting frame, the inverted rotating configurations will be used.

Column Strength: The jacks will be loaded in tension, therefore column strength does not need to be considered

Speed and Horsepower: Using a standard 1750 AC Motor and the 2.5HL-BSJ with the 12:1 gear ratio, full travel would be reached in 3.5 seconds. Using the horsepower formulas on page 15, a 2 HP AC motor running at 1750 rpm will be adequate for the requirements.

$$HP_{\text{per jack}} = \frac{.0244 \text{ in-lb} \times 566 \text{ lb} \times 1,725 \text{ rpm}}{63,025} = .38 \text{ hp / jack}$$

$$HP_{\text{arrangement}} = \frac{.38 \text{ hp per jack} \times 3 \text{ jacks}}{.9 \times (.9)^2} = 1.55 \text{ total hp}$$

LinkJac™ Line Shafting: The longest center to center distance between the jack and gearbox is 24 inches, leaving a shaft length of 17 inches. Using the formula on page 193 based on Torsional Twist, the proper Line Shafting to use would be the LJ-8.

$$N_{\text{Speed}} = .6692 \times \left(\frac{\pi}{17 \text{ in}}\right)^2 \times 3.895 \times 10^5 = 44,547 \text{ rpm}$$

$$N_{\text{Twist}} = 41.48 \text{ in-lb} \times \left(\frac{17 \text{ in}}{1,235}\right) = .57^\circ$$

SELECTION

Reference Number: From page 31, create reference numbers for the following: three 2.5 ton ball screw jacks, inverted rotating configuration, 12:1 worm gear ration, 15 inches "L" dimension.

Jacks:

(3) 2.5-BSJ-IR 12:1/SSE-1/SSE-2/FA/15/S

Gearboxes:

(2) GB210 Type D

Shafting:

(2) LJ-8 17" OAL

(1) LJ-8 12" OAL

Couplings:

(3) P-2200-XX (½ - ½)

(5) P-2200-178 (¾ - ¾)

Motor:

2 HP AC Motor 1750 rpm



IN-LINE ARRANGEMENT



A steel tube manufacturer is developing a new OD polisher that will increase production by 22%. Because of the increased production time, the set-up crew is unable to set the feed table manually and is looking to automate the feed table height using screw jack actuators. The feed table length is 24 feet and weighs 5,600 lbs with the largest diameter steel pipe. The table height will need to change approximately once every 15 minutes, but no more than 10 times a day. Maximum height change is 9 inches. The travel rate is .4 inches per second.

SPECIFICATIONS

- Single motor and drive, with the possibility to remove the motor and drive by hand
- The load will be in compression.
- Total travel 14 inches
- .25 inches in 1 second

ANALYSIS

Configuration: Because of the possibility to be hand driven, a machine screw jack with 24:1 gear ratio is needed to prevent back driving. Based on the mounting constraints, the upright translating jack with a clevis rod end will be used. Due to the length of the feed table, four jacks will be used in-line with a center mounted motor through a single gearbox.



Column Strength: The jacks will be loaded in compression and in mounting condition D. Based on the load and number of jacks, the 2.5-MSJ jack or larger could be used.

Speed and Horsepower: Using a standard 1750 AC motor and the 2.5-MSJ with 12:1 gear ratio, the travel rate will be .6 inches per second. Using the horsepower formula on page 15, the horsepower limit would be exceeded. Using the 5-MSJ 24:1 gear ratio, the travel rate will be .45 inches per second and the horsepower per jack will be sufficient to lift the load. A 3 HP motor would be adequate for the requirements.

$$HP_{\text{per jack}} = \frac{.0144 \text{ in-lb} \times 1,400 \text{ lb} \times 1,725 \text{ rpm}}{63,025} = .56 \text{ hp / jack}$$

$$HP_{\text{arrangement}} = \frac{.56 \text{ hp per jack} \times 4 \text{ jacks}}{.85 \times .9} = 2.92 \text{ total hp}$$

LinkJac™ Line Shafting: The longest center to center distance between the jack and gearbox is 48 inches, leaving a shaft length of 41 inches. Since the motor is located in the middle, only half the total torque is needed for calculated torsional twist. Using the formula on page 193, the proper Line Shafting to use would be the LJ-16.

$$N_{\text{Speed}} = .6192 \times \left(\frac{\pi}{41 \text{ in}}\right)^2 \times 1.168 \times 10^6 = 4,246 \text{ rpm}$$

$$N_{\text{Twist}} = 40.32 \text{ in-lb} \times \left(\frac{41 \text{ in}}{19,500}\right) = .09^\circ$$

SELECTION

Reference Number: From page 69, create reference numbers for the following: three 2.5 ton ball jacks, upright translating configuration, 24:1 worm gear ration, 14 inches travel.

Jacks:

(4) 5-MSJ-U 24:1/SSE-1/SSE-2/FC/14/S

Gearboxes:

(1) GB210S Type D

Shafting:

(2) LJ-16 17" OAL

(1) LJ-16 12" OAL

Couplings:

(8) C-1805-02 (¾- 1)

Motor:

3 HP AC Motor 1750rpm



BALL SCREW JACKS

ActionJac™ Ball Screw Jacks have been designed to produce rated output forces with a minimum amount of input torque. Ball screw jacks use a worm gear set arrangement with an efficient ball screw and nut that reduces the amount of input torque to approximately one-third the torque required for the Machine Screw Jack.

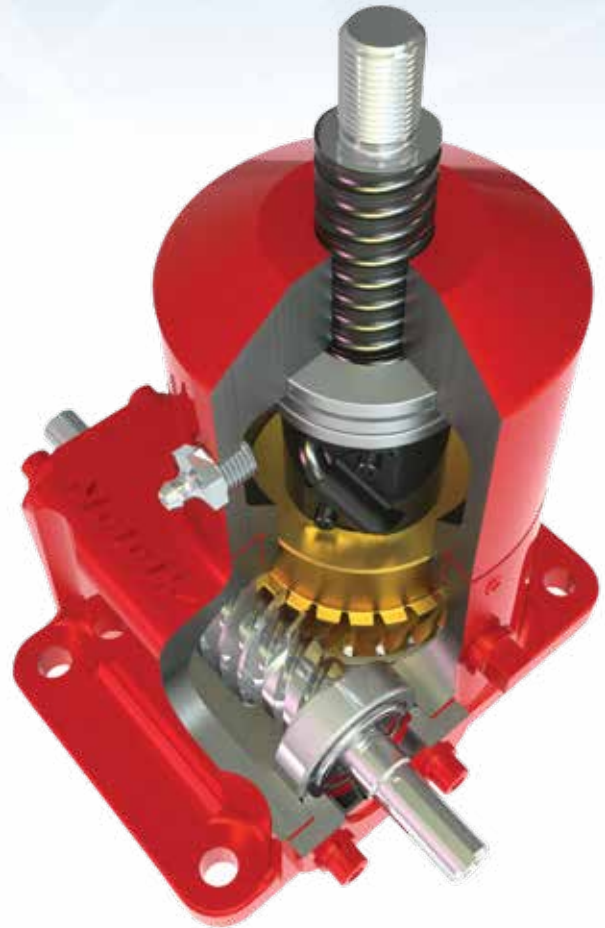

Nook/Thomson ball screw jacks are used extensively in the automobile manufacturing industry.



BALL SCREW JACKS22-31

PowerTrac™ Precision Ball Screws...24-25
 Quick Reference26-27
 Life Expectancy28-29
 Column Strength.....30
 Reference Number System31

TECHNICAL DATA32-61

0.5-BSJ / 0.5HL-BSJ32-33
 1-BSJ.....34-35
 1HL-BSJ36-37
 2-BSJ38-38
 2R-BSJ.....40-41
 2.5-BSJ42-43
 2.5HL-BSJ44-45
 3-BSJ46-47
 5-BSJ / 5HL-BSJ48-49
 10-BSJ / 10HL-BSJ.....50-51
 20-BSJ / 20HL-BSJ52-53
 30-BSJ-30HL-BSJ54-55
 50-BSJ56-57
 75-BSJ58-59
 100-BSJ.....60-61

BALL SCREW JACKS

BALL SCREW TECHNICAL INFORMATION

Nook/Thomson ball screw jacks are fitted with our own PowerTrac™ Ball Screws and Nuts.

STRAIGHTNESS - PowerTrac™ Ball Screws are straight within .010 inch/foot when shipped from the factory, and do not exceed .030 inch in any 6 foot section.

Material	Surface	L e a d		S c r e w Lengths
		Accuracy	Screw Dia.	
Alloy	black	± .004 in/ft	0.375" 6.000"	to up to 24'

LIFE - A jack assembly uses rolling elements to carry a load similar to an anti-friction (ball) bearing. These elements do not wear during normal use, but rather fatigue. Therefore, ball screw life is predictable and is determined by calculating the fatigue failure of the components.

Proper lubrication, regular maintenance, and operation within specified limits will allow PowerTrac™ Ball Screws to operate to the predicted life.

BACKLASH - Backlash (lash) is the relative axial movement between a screw and nut without rotation of the screw or nut. The axial movement between a new PowerTrac™ ball nut and screw will range from .003" to .015" depending on size. Lash in ball screws will remain constant during normal use.

SELECTIVE FIT - When less than standard lash (listed above) is desired, ball nuts can be custom-fit to a specific screw with selected bearing balls to minimize lash to .003" to .005" depending on ball size. Select fitting may result in lower life.

LOAD DEFINITIONS

CAPACITY - The maximum thrust load – including shock – that can be applied to the ball nut without damaging the assembly.

OPERATING LOAD - The thrust load in pounds which, when applied to the ball nut and rotating screw assembly, will result in a minimum life of 1,000,000 inches of travel. Metric screw designs are per ISO 3408 and show the load ratings in kilonewtons for 1 million revolutions.

TENSION LOAD - A load that tends to “stretch” the screw. (See FIG. 1)

COMPRESSION LOAD - A load that tends to “squeeze” the screw. (See FIG. 1)

FIG. 1

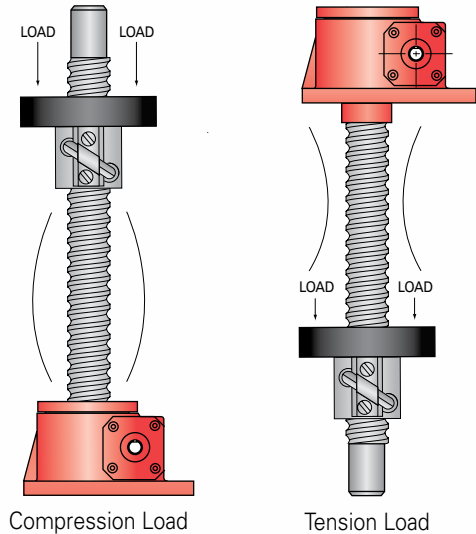

OVERTURNING LOAD - A load that tends to rotate the nut radially around the longitudinal axis of the screw. (See FIG. 2)

SIDE LOAD - A load that is applied radially to the nut. (See FIG. 2)

CAUTION: Although a side load will not prevent the ball screw from operating, the nut is not designed to operate with a side load, such as those generated from pulleys, drive belts, misalignment, etc.

THRUST LOAD - A load parallel to and concentric with the axis of the screw. (See FIG. 2)

FIG. 2

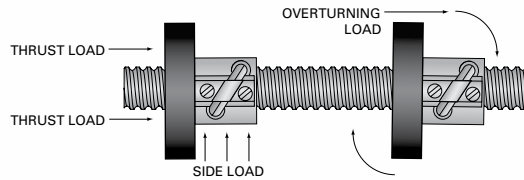

DESIGN CONSIDERATIONS

STANDARD FLANGE ORIENTATION - Standard flange orientation varies with the number of holes in the flange. Unless otherwise specified, a factory-assembled flange will be oriented on the nut as shown. (See FIG. 3)

FIG. 3

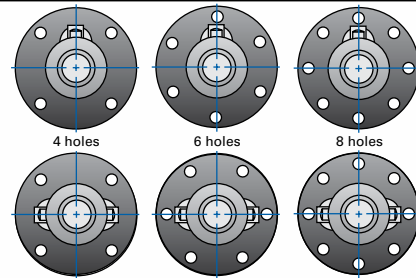

PROPER BALL NUT ORIENTATION - When a ball screw assembly is used in an orientation other than vertical, it is important to orient the return tubes to optimize ball nut operation. (See FIG. 4)

FIG. 4

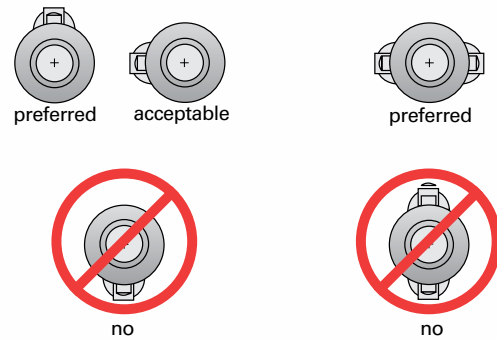

QUICK REFERENCE

BALL SCREW JACKS

MODEL	Gear ratio	Capacity (tons)	Lifting Screw Dia (in)	Screw Lead (in)	Root Dia (in)	Turns of Worm for 1" travel	Max input Torque (in.-lb.)	Max Input (hp)	Max Worm Speed at Rated Load (rpm)	Max Load at 1,750 rpm (lb)	Torque to Raise 1 lb. (in-lb)	Tare Drag Torque (in-lb)	Backdrive Holding Torque (ft-lb)
0.5-BSJ	5:1	½	⅝	.200	.500	25	9.5	⅓	1,800	1,000	.0095	1	1.0
	20:1	½	⅝	.200	.500	100	4.0	⅙	1,800	1,000	.0040	1	.25
0.5HL-BSJ	5:1	½	⅝	.500	.500	10	24.2	⅓	868	496	.0242	1	2
	20:1	½	⅝	.500	.500	40	10.2	⅙	1,030	588	.0102	1	1
1-BSJ	5:1	1	¾	.200	.602	25	19	½	1,660	1,895	.0095	3	1.5
	20:1	1	¾	.200	.602	100	9	¼	1,750	2,000	.0045	3	.50
1HL-BSJ	5:1	1	¾	.500	.602	10	48.2	½	654	747	.0241	3	3.5
	20:1	1	¾	.500	.602	40	9	¼	691	790	.0114	3	1.5
2-BSJ	6:1	2	1	.250	.820	24	40	2	1,800	4,000	.0100	4	3
	12:1	2	1	.250	.820	48	26	1½	1,800	4,000	.0064	4	1.5
	24:1	2	1	.250	.820	96	17	½	1,800	4,000	.0043	4	1
2R-BSJ	6:1	2	1	.250	.820	24	40	2	1,800	4,000	.0100	4	3
	12:1	2	1	.250	.820	48	26	1½	1,800	4,000	.0064	4	1.5
	24:1	2	1	.250	.820	96	17	½	1,800	4,000	.0043	4	1
2.5-BSJ	6:1	2½	1	.250	.820	24	51	2	1,800	5,000	.0102	5	4
	12:1	2½	1	.250	.820	48	31	1½	1,800	5,000	.0061	5	2
	24:1	2½	1	.250	.820	96	21	½	1,500	4,287	.0042	5	1.5
2.5HL-BSJ	6:1	2½	1	1.00	.820	6	202	2	624	1,783	.0404	5	14
	12:1	2½	1	1.00	.820	12	122	1½	775	2,214	.0244	5	6
	24:1	2½	1	1.00	.820	24	85	½	371	1,059	.0170	5	5
3-BSJ	6:1	3	1⅞	.413	.870	14.53	100	2	1,260	4,313	.0167	6	6
	24:1	3	1⅞	.413	.870	58.10	42	½	750	2,572	.0070	6	2

NOTES:

- 1) The recommended maximum speed is 3,000 rpm provided that the recommended horsepower and temperature are not exceeded.
- 2) Input torque is shown as torque to lift one pound of load. Starting torque is 50% greater than torque shown. For loads less than 25% of rated loads add tare drag torque.
- 3) Maximum (allowable) horsepower ratings are based on a 35% duty cycle at standard ambient temperature, with 1 minute on 2 minute off cycles. For operation at higher duty cycles or repeated use over any segment of the total travel, temperature must be monitored and remain less than 200°F.
- 4) Overload capacity of the Ball Screw Jack is as follows: 10% for dynamic loads, 30% for static loads.

5) All Ball Screw Jacks can backdrive and require some means of holding the load, such as a brake on the motor. The product specification pages show holding torque values. Holding torque represents the amount of input torque required to restrain the load and does not indicate recommended brake size to bring the dynamic load to a stop.

6) All units are suitable for intermittent operation providing that the housing temperature including ambient is not lower than -20°F or higher than +200°F. Factory supplied grease in standard units will operate in this range.

For higher or lower operating temperature ranges consult Nook/Thomson.

MODEL	Gear ratio	Capacity (tons)	Lifting Screw Dia (in)	Screw Lead (in)	Root Dia (in)	Turns of Worm for 1" travel	Max input Torque (in.-lb.)	Max Input (hp)	Max Worm Speed at Rated Load (rpm)	Max Load at 1,750 rpm (lb)	Torque to Raise 1 lb. (in.-lb)	Tare Drag Torque (in.-lb)	Backdrive Holding Torque (ft.-lb)
5-BSJ	6:1	5	1½	.473	1.140	12.66	183	3	1,033	5,904	.0183	10	14
	24:1	5	1½	.473	1.140	50.66	73	¾	647	3,700	.0073	10	5
5HL-BSJ	6:1	5	1½	1.00	1.140	6	387	3	488	2,792	.0387	10	30
	24:1	5	1½	1.00	1.140	24	153	¾	308	1,765	.0153	10	10
10-BSJ	8:1	10	1½	.473	1.140	16.88	302	5	1,043	11,925	.0151	20	13
	24:1	10	1½	.473	1.140	50.66	153	1½	618	7,016	.0077	20	4
10HL-BSJ	8:1	10	1½	1.00	1.140	8	638	5	494	5,645	.0319	20	26
	24:1	10	1½	1.00	1.140	24	323	1½	293	3,335	.0162	20	6
20-BSJ	8:1	20	2¼	.50	1.850	16	626	7½	755	17,204	.0157	40	27
	24:1	20	2¼	.50	1.850	48	314	2½	501	11,397	.0079	40	7
20HL-BSJ	8:1	20	2¼	1.00	1.850	8	1,253	7½	377	8,629	.0313	40	54
	24:1	20	2¼	1.00	1.850	24	628	2½	251	5,737	.0157	40	13
30-BSJ	10¾:1	30	3	.66	2.480	16.16	969	11	715	24,515	.0162	60	21
	32:1	30	3	.66	2.480	48.48	503	3½	438	15,006	.0084	60	5
30HL-BSJ	10¾:1	30	3	1.5	2.480	7.11	2,292	11	315	10,794	.0367	60	67
	32:1	30	3	1.5	2.480	21.33	1,144	3½	193	6,600	.0191	60	15
50-BSJ	10¾:1	50	4	1.0	3.338	10.66	2,560	16	394	22,509	.0256	90	75
	32:1	50	4	1.0	3.338	32	1,390	5	227	12,954	.0139	90	10
75-BSJ	10¾:1	75	4	1.0	3.338	10.66	3,660	28	482	41,328	.0244	155	110
	32:1	75	4	1.0	3.338	32	1,680	9	338	28,970	.0112	155	25
100-BSJ	10¾:1	100	4	1.0	3.338	10.66	4,880	32	413	47,232	.0244	205	152
	32:1	100	4	1.0	3.338	32	2,760	12½	285	32,621	.0138	205	35

7) Accessories such as boots, limit switches, top plates and clevises are available.

8) Catalog dimensions are representative only and are subject to change without notice. For construction, use only certified prints.

9) Units are not to be used for the purpose of personnel support or movement.

10) End-of-travel stops are not provided.

11) Tare drag torque need only be added if operating under 25% rated load.

$$\text{Horsepower per jack} = \frac{\text{Torque to raise one pound} \times \text{Number of pounds to be raised} \times \text{rpm}}{63,025}$$

12) Starting Torque is 50% greater than torque shown.

13) Measurements listed are for non-keyed jacks. See individual jack pages for keyed jack info.

LIFE EXPECTANCY BALL SCREW JACKS

MODEL	OPERATING LOAD (lbs)	MINIMUM INCHES OF TRAVEL (in. x 10 ³)			
		UPRIGHT & INVERTED		UPRIGHT & INVERTED ROTATING	
		Standard (in)	High-lead (in)	Standard (in)	High-lead (in)
0.5-BSJ 0.5HL-BSJ	1,000	377	708	471	885
	750	893	1,678	116	2,097
	500	3,014	5,662	3,767	7,078
	250	24,111	45,299	56,623	56,623
1-BSJ 1HL-BSJ	2,000	133	2,019	166	2,524
	1,500	316	4,785.9	394	5,982
	1,000	1,065	16,152	1,331	20,190
	500	8,518	129,218	10,648	161,523
2-BSJ 2R-BSJ	4,000	52	—	66	—
	3,000	124	—	155	—
	2,000	419	—	524	—
	1,000	3,351	—	4,189	—
2.5-BSJ 2.5HL-BSJ	5,000	27	63	34	79
	3,750	64	149	79	186
	2,500	215	503	268	629
	1,250	1,716	4,026	2,145	5,031
3-BSJ	6,000	219	—	273	—
	4,500	518	—	648	—
	3,000	1,750	—	2,187	—
	1,500	13,996	—	17,495	—
5-BSJ 5HL-BSJ	10,000	812	346	1,015	432
	7,500	1,925	819	2,406	1,024
	5,000	6,497	2,765	8,121	1,024
	2,500	51,972	22,123	64,965	27,653



Nook ball screw jacks are used in the manufacture of airplane components.



MODEL	OPERATING LOAD (lbs)	INCHES OF TRAVEL (in. x 10 ³)			
		UPRIGHT & INVERTED		UPRIGHT & INVERTED ROTATING	
		Standard (in)	High-lead (in)	Standard (in)	High-lead (in)
10-BSJ 10HL-BSJ	20,000	102	43	127	54
	15,000	241	103	301	128
	10,000	812	346	1,015	432
	5,000	6,497	2,765	8,121	3,457
20-BSJ 20HL-BSJ	40,000	121	234	151	292
	30,000	287	554	358	692
	20,000	967	1,869	1,209	2,336
	10,000	7,737	14,952	9,672	18,690
30-BSJ 30HL-BSJ	60,000	323	572	403	715
	45,000	764	1,355	955	1,694
	30,000	2,579	4,574	3,223	5,718
	15,000	20,630	36,596	25,787	45,744
50-BSJ	100,000	505	—	631	—
	75,000	1,196	—	1,495	—
	50,000	4,037	—	5,046	—
	25,000	32,292	—	40,365	—
75-BSJ	150,000	150	—	187	—
	112,500	354	—	443	—
	75,000	1,196	—	1,495	—
	37,500	9,568	—	11,960	—
100-BSJ	200,000	63	—	79	—
	150,000	150	—	187	—
	100,000	505	—	631	—
	50,000	4,037	—	5,046	—



Nook/Thomson ball screw jacks are used in numerous maritime applications.

COLUMN STRENGTH BALL SCREW JACKS

Column strength is the ability of the lift shaft to hold compressive loads without buckling. With longer screw lengths, column strength may be substantially lower than nominal jack capacity.

If the lift shaft is in tension only, the screw jack travel is limited by the available screw material or by the critical speed of the screw. For critical speed limitations, contact Nook/Thomson Engineering. If there is any possibility for the lift shaft to go into compression, the application should be sized for sufficient column strength.

The chart below is used to determine the required jack size in applications where the lift shaft is loaded in compression.

TO USE THIS CHART:

Find a point at which the maximum length "L" intersects the maximum load. Be sure the jack selected is above and to the right of that point.

CAUTION: chart does not include a design factor.

The chart assumes proper jack alignment with no bending loads on the screw. Effects from side loading are not included in this chart. Jacks operating horizontally with long lift shafts can experience bending from the weight of the screw.

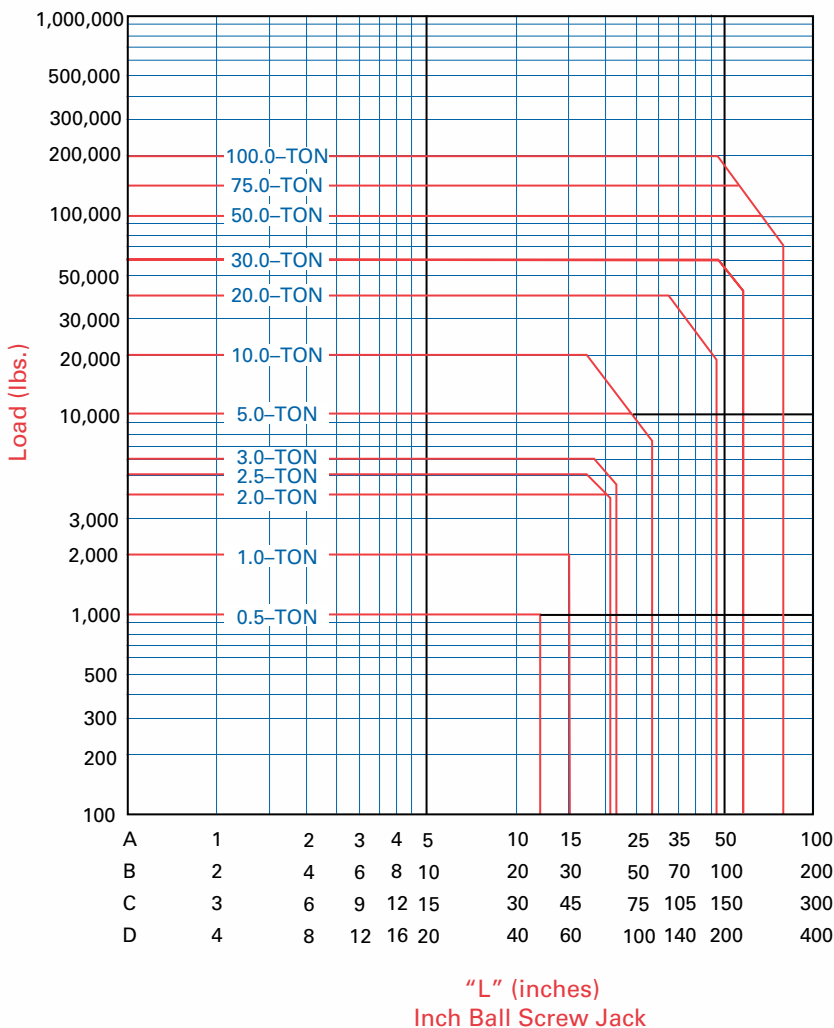

MOUNTING CONDITIONS

A

ONE END FIXED
ONE END FREE

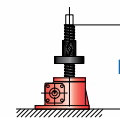

B

ONE END BY CLEVIS,
BASE END BY CLEVIS OR TRUNNION PLATE

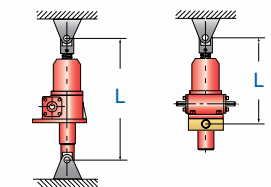

C

ONE END FIXED,
ONE END SUPPORTED
(CLEVIS ATTACHED TO GUIDE STRUCTURE)

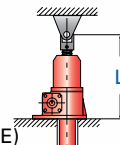

ONE END FIXED,
ONE END SUPPORTED
(RADIAL BEARING)

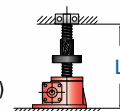

D

BOTH ENDS FIXED
(TOP PLATE ATTACHED TO GUIDED STRUCTURE)

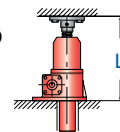

AVAILABLE LIFT SCREW LENGTHS

As a major manufacturer of industrial lead screws, Nook/Thomson stocks a wide selection of ball screws. Nook/Thomson has the capacity to make long ball screws for special applications. Rotating

screw jacks can be built with a larger diameter lift screw for greater column strength, or a different lead to change the jack operating speed.

REFERENCE NUMBER SYSTEM

INCH BALL SCREW JACKS

2.5-BSJ-U 6:1 / 10BT-1 / 2CA-2C / FT / 24.5 / BS

BALL SCREW MODEL

Model #	Model #
0.5-BSJ	5HL-BSJ
0.5HL-BSJ	10-BSJ
1-BSJ	10HL-BSJ
1HL-BSJ	20-BSJ
2-BSJ	20HL-BSJ
2R-BSJ	30-BSJ
2.5-BSJ	30HL-BSJ
2.5HL-BSJ	50-BSJ
3-BSJ	75-BSJ
5-BSJ	100-BSJ

CONFIGURATION

U = Upright	DC = Double Clevis
I = Inverted	UK = Upright Keyed
UR = Upright Rotating	IK = Inverted Keyed
IR = Inverted Rotating	

GEAR RATIO

Refer to product pages for available ratios.

SHAFT ORDER CODE

10BT - 1

CCW Position 1, 3, 5 & 7
CW Position 2, 4, 6 & 8

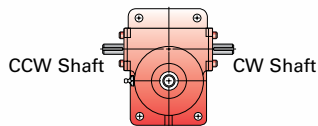

ORDER CODES (Must Include A Position)

NOTE: Both Shaft Extensions Must Be Specified

No Accessory

- SSE- = Standard Shaft Extension, Position 1 or 2
- 000- = Delete Shaft Extension, Position 1 or 2
- SPC- = Special Modified Shaft Extension, Position 1 or 2

Motor Mounts Without Motor (Position 1 or 2)

Used on 2.5 to 20 Ton Jacks. See pages 180-181 for standard motor mount order codes.

Motor Mounts With Motors (Position 1 or 2)

Used on 2.5 to 20 Ton Jacks. see pages 180-181 & 184 for available motors.

Right Angle Reducer (Position 1 through 8)

Used on 2.5 to 20 Ton Jacks. See pages 182-183 for available Right Angle Reducers.

Limit Switches (Position 1 C or E through 8 C or E)

Used on 2 to 100 Ton Jacks. See pages 192-197 for available limit switches.

HOUSING CONFIGURATION

- F = Standard Flange Base
- C = Clevis Base
- T = Trunnion Base

SCREW CONFIGURATION

TRANSLATING - U and I MODELS

- T = Standard Threaded End
- C = Clevis End
- P = Top Plate

ROTATING - UR and IR MODELS

- A = Travel Nut Position "A"
- B = Travel Nut Position "B"

UR - Upright Rotating IR - Inverted Rotating

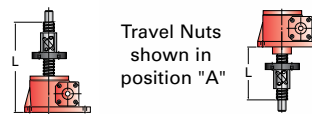

TRAVEL

For Translating Screw Models (U and I) use actual Travel in inches.
For Rotating Screw Models (UR and IR) use "L" Dimension in inches.

MODIFIER LIST

- E and/or B Optional
- E = In-Line Encoder (Motor or motor mount required)
- B = Bellows Boots (See page 204-205. Must calculate extend and retract length.)
- P = Nook Tube Sensor System PNP
- N = Nook Tube Sensor System NPN
- S or M Required
- S = Standard. no additional description required
- M = Modified, additional description required

0.5-BSJ 0.5HL-BSJ

0.5-BSJ & 0.5HL-BSJ TOP VIEW

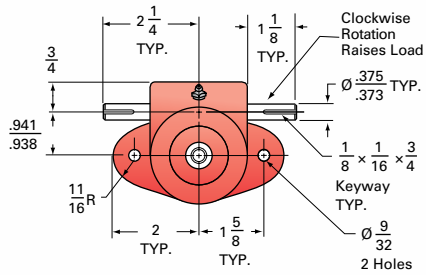

0.5-BSJ-U & 0.5HL-BSJ-U UPRIGHT

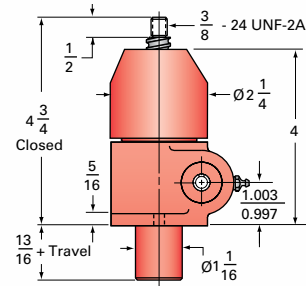

0.5-BSJ-I & 0.5HL-BSJ-I INVERTED

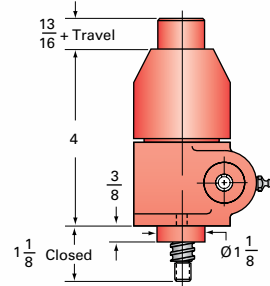

MODEL	Gear Ratio	Turns of Worm for 1" Travel	Max Input Torque (in-lb)	Max Allowable Input (hp)	Tare Drag Torque (in-lb)	Backdrive Holding Torque (ft-lb)
0.5-BSJ Capacity: 0.5 tons Screw: 0631-0200	5:1	25	9.5	1/3	1	1.0
	20:1	100	4.0	1/6	1	.25
0.5HL-BSJ Capacity: 0.5 tons Screw: 0631-0500	5:1	10	24.2	1/3	1	2
	20:1	40	10.2	1/6	1	1

Screw Specs:
 Root diameter (in): 0.500
 Start torque = 1.5 x Running Torque
 Approximate weight (lbs)
 "0" Travel: 3
 Per inch travel: 0.03
 Grease: 0.3

Caution: Jack is self-lowering. Lifting screw must be secured to prevent rotation for non-keyed units.

0.5-BSJ-UR & 0.5HL-BSJ-UR
UPRIGHT ROTATING

FOR ORDERING: Specify "L"
dimension L (min) = Travel + $4\frac{3}{8}$

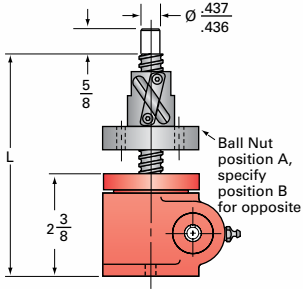

0.5-BSJ-IR & 0.5HL-BSJ-IR
INVERTED ROTATING

FOR ORDERING: Specify "L"
dimension L (min) = Travel + $2\frac{5}{8}$

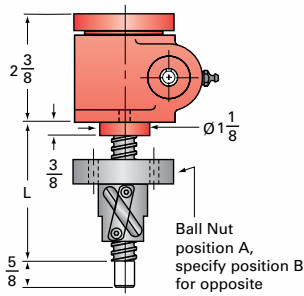

0.5-BSJ-IK & 0.5HL-BSJ-IK
UPRIGHT KEYED

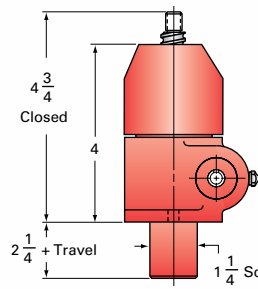

0.5-BSJ-IK & 0.5HL-BSJ-IK
INVERTED KEYED

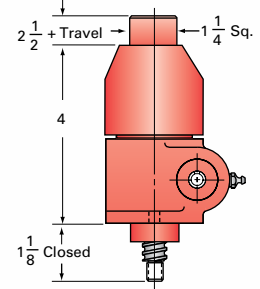

NON-KEYED			KEYED		
Torque to raise 1 lb (in-lb)	Max Worm Speed at Rated Load (rpm)	Max Load at 1,750 rpm (lb)	Torque to raise 1 lb (in-lb)	Max Worm Speed at Rated Load (rpm)	Max Load at 1,750 rpm (lb)
.0095	1,800 rpm	1,000	.0105	1,800	1,000
.0040	1,800 rpm	1,000	.0044	1,080	1,000
.0242	868 rpm	496	.0266	790	450
.0102	1,030 rpm	588	.0112	936	534

0.5-BSJ Ball Nut and Flange

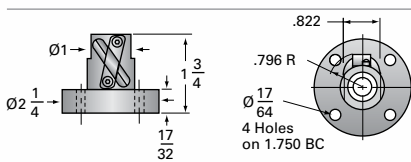

0.5HL-BSJ Ball Nut and Flange

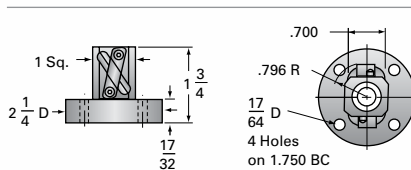

0.5-BSJ & 0.5HL-BSJ Options

Top Plate (optional): 9000-00-12

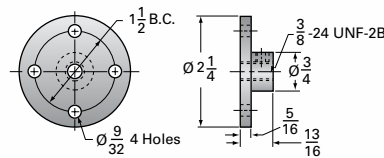

Clevis End (optional): 9001-00-12

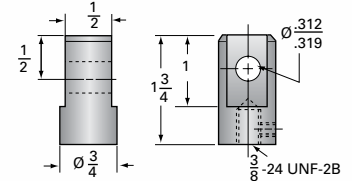

1-BSJ

1-BSJ TOP VIEW

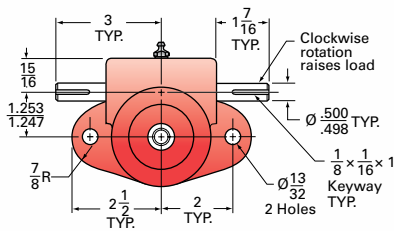

1-BSJ-U UPRIGHT

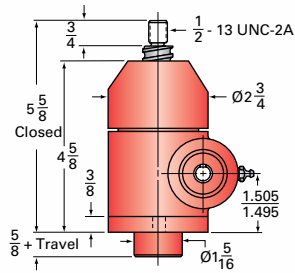

1-BSJ-I INVERTED

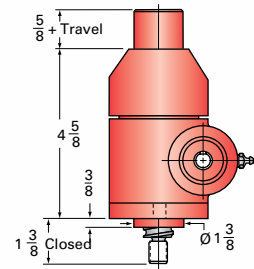

MODEL	Gear Ratio	Turns of Worm for 1" Travel	Max Input Torque (in-lb)	Max Allowable Input (hp)	Tare Drag Torque (in-lb)	Backdrive Holding Torque (ft-lb)
1-BSJ	5:1	25	19	1/2	3	1.5
Capacity: 1 ton Screw: 0750-0200	20:1	100	9	1/4	3	.5

Screw Specs:
 Root diameter (in): 0.602
 Start torque = 1.5 x Running Torque
 Approximate weight (lbs)
 "0" Travel: 8
 Per inch travel: 0.04
 Grease: 0.5

1-BSJ-DC DOUBLE CLEVIS

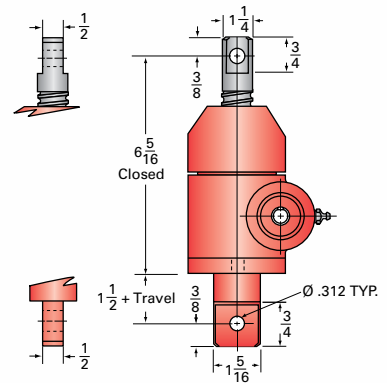

Caution: Jack is self-lowering. Lifting screw must be secured to prevent rotation for non-keyed units.

1-BSJ-UR UPRIGHT ROTATING

FOR ORDERING: Specify "L"
dimension L (min) = Travel + $5 \frac{21}{32}$

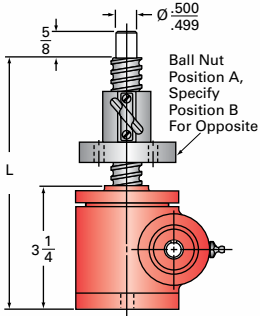

1-BSJ-IR INVERTED ROTATING

FOR ORDERING: Specify "L"
dimension L (min) = Travel + $2 \frac{25}{32}$

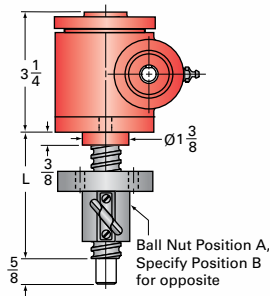

1-BSJ-UK UPRIGHT KEYED

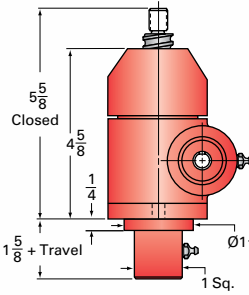

1-BSJ-IK INVERTED KEYED

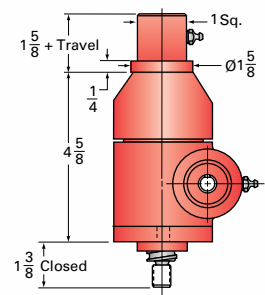

	NON-KEYED			KEYED		
	Torque to raise 1 lb (in-lb)	Max Worm Speed at Rated Load (rpm)	Max Load at 1,750 rpm (lb)	Torque to raise 1 lb (in-lb)	Max Worm Speed at Rated Load (rpm)	Max Load at 1,750 rpm (lb)
	.0095	1,660	1,895	.0104	1,515	1,731
	.0045	1,750 rpm	2,000	.0049	1,608	1,837

1-BSJ Ball Nut and Flange

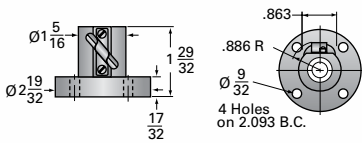

1-BSJ Options

Top Plate (optional): 9000-00-11

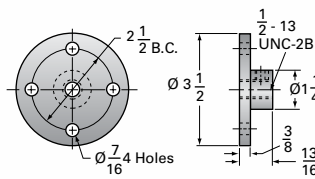

Clevis End (optional): 9001-00-11

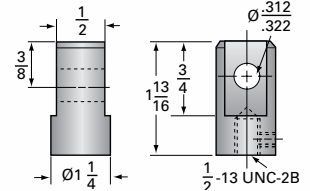

1HL-BSJ

1HL-BSJ TOP VIEW

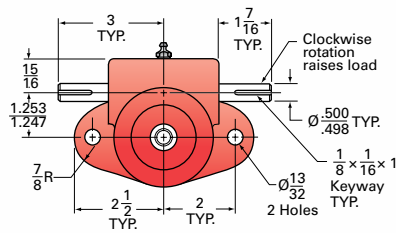

1HL-BSJ-U UPRIGHT

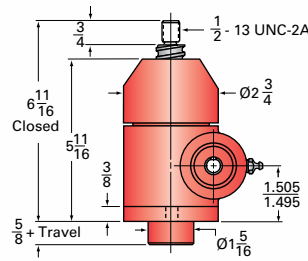

1HL-BSJ-I INVERTED

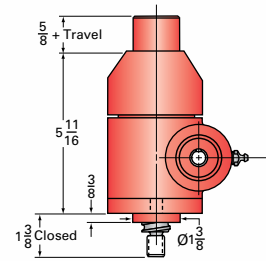

MODEL	Gear Ratio	Turns of Worm for 1" Travel	Max Input Torque (in-lb)	Max Allowable Input (hp)	Tare Drag Torque (in-lb)	Backdrive Holding Torque (ft-lb)
1HL-BSJ	5:1	10	48.2	1/2	3	3.5
Capacity: 1 ton Screw: 0750-0500	20:1	40	22.8	1/4	3	1.5

Screw Specs:
 Root diameter (in): 0.602
 Start torque = 1.5 x Running Torque
 Approximate weight (lbs)
 "0" Travel: 8
 Per inch travel: 0.04
 Grease: 0.5

1HL-BSJ-DC DOUBLE CLEVIS

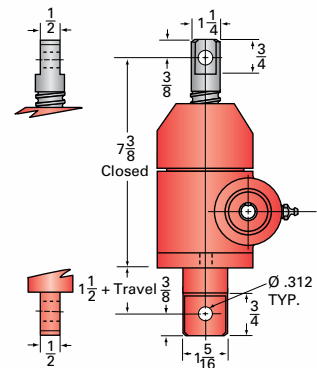

Caution: Jack is self-lowering. Lifting screw must be secured to prevent rotation for non-keyed units.

1HL-BSJ-UR UPRIGHT ROTATING

FOR ORDERING: Specify "L"
dimension L (min) = Travel + $6\frac{11}{16}$

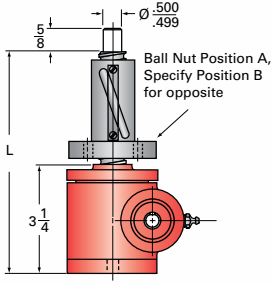

1HL-BSJ-IR INVERTED ROTATING

FOR ORDERING: Specify "L"
dimension L (min) = Travel + $3\frac{13}{16}$

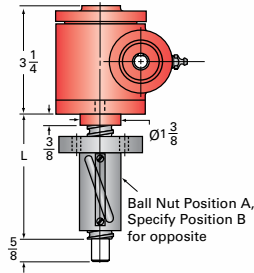

1HL-BSJ-UK UPRIGHT KEYED

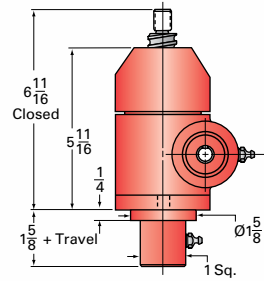

1HL-BSJ-IK INVERTED KEYED

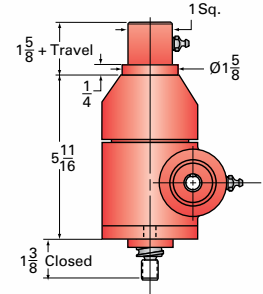

	NON-KEYED			KEYED		
Torque to raise 1 lb (in-lb)	Max Worm Speed at Rated Load (rpm)	Max Load at 1,750 rpm (lb)	Torque to raise 1 lb (in-lb)	Max Worm Speed at Rated Load (rpm)	Max Load at 1,750 rpm (lb)	
.0241	654	747	.0265	595	680	
.0114	691	790	.0125	628	718	

1HL-BSJ Ball Nut and Flange

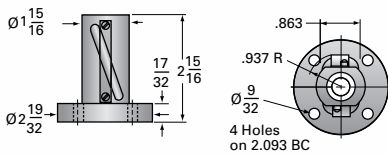

1HL-BSJ Options

Top Plate (optional): 9000-00-11

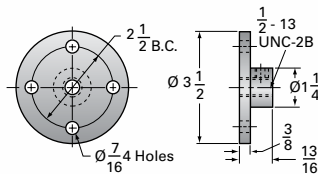

Clevis End (optional): 9001-00-11

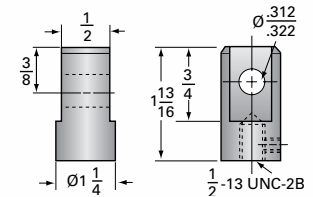

2-BSJ

2-BSJ TOP VIEW

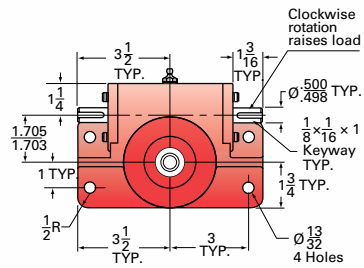

2-BSJ-U UPRIGHT

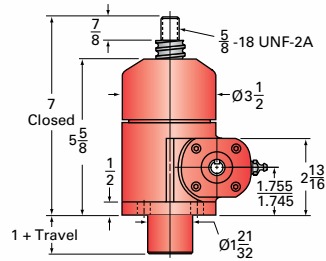

2-BSJ-I INVERTED

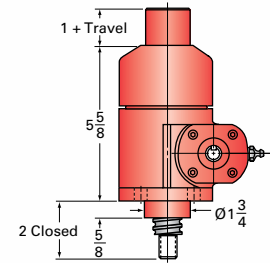

MODEL	Gear Ratio	Turns of Worm for 1" Travel	Max Input Torque (in-lb)	Max Allowable Input (hp)	Tare Drag Torque (in-lb)	Backdrive Holding Torque (ft-lb)
2-BSJ Capacity: 2 tons Screw: 1000-0250	6:1	24	40	2	4	3
	12:1	48	26	1 1/2	4	1.5
	24:1	96	17	1/2	4	1

Screw Specs:
 Root diameter (in): 0.820
 Start torque = 1.5 x Running Torque
 Approximate weight (lbs)
 "0" Travel: 18
 Per inch travel: 0.6
 Grease: 0.5

2-BSJ-DC DOUBLE CLEVIS

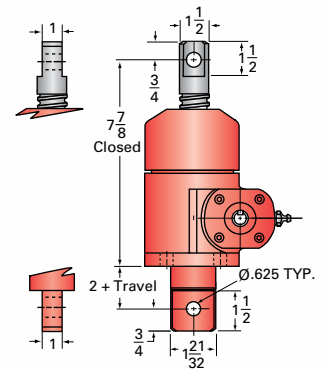

Caution: Jack is self-lowering. Lifting screw must be secured to prevent rotation for non-keyed units.

2-BSJ-UR UPRIGHT ROTATING

For ordering, specify "L" dimension
L(min) = travel + $7\frac{5}{16}$

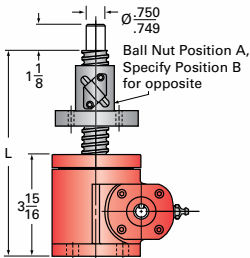

2-BSJ-IR INVERTED ROTATING

For ordering, specify "L" dimension
L(min) = travel + 4

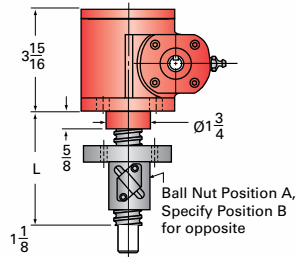

2-BSJ-UK UPRIGHT KEYED

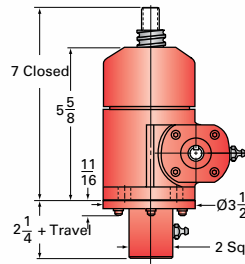

2-BSJ-IK INVERTED KEYED

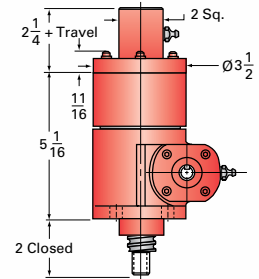

Torque to raise 1 lb (in-lb)	NON-KEYED		KEYED	
	Max Worm Speed at Rated Load (rpm)	Max Load at 1,750 rpm (lb)	Max Worm Speed at Rated Load (rpm)	Max Load at 1,750 rpm (lb)
.0100	1,800	4,000	.0110	1,636
.0064	1,800	4,000	.0070	1,636
.0043	1,800	4,000	.0047	1,636

2-BSJ Ball Nut and Flange

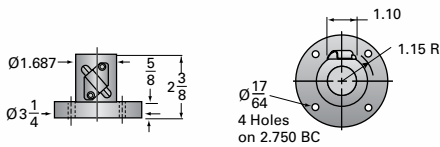

2-BSJ Options

Top Plate (optional): 9000-00-01

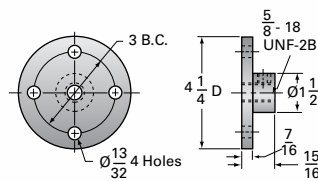

Motor Mount
see pg 180-181

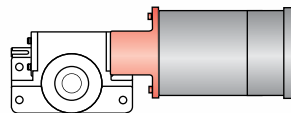

Clevis End (optional): 9001-00-01

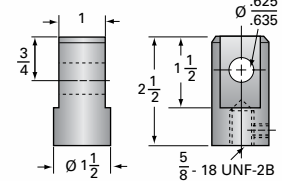

Limit Switch
see pg 196-201

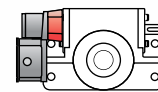

2R-BSJ

2R-BSJ TOP VIEW

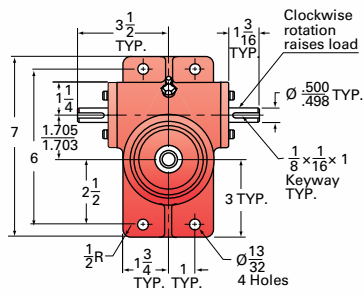

2R-BSJ-U UPRIGHT

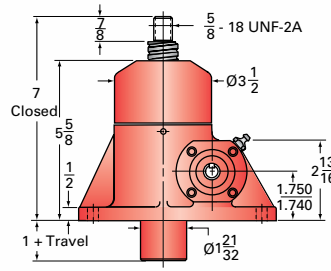

2R-BSJ-I INVERTED

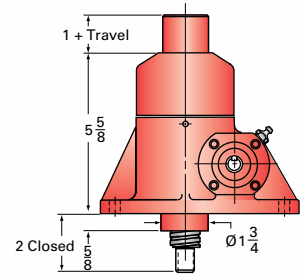

MODEL	Gear Ratio	Turns of Worm for 1" Travel	Max Input Torque (in-lb)	Max Allowable Input (hp)	Tare Drag Torque (in-lb)	Backdrive Holding Torque (ft-lb)
2R-BSJ	6:1	24	40	2	4	3
Capacity: 2 tons Screw: 1000-0250	12:1	48	26	1 1/2	4	1.5
	24:1	96	17	1/2	4	1

Screw Specs:
 Root diameter (in): 0.820
 Start torque = 1.5 x Running Torque
 Approximate weight (lbs)
 "0" Travel: 18
 Per inch travel: 0.6
 Grease: 0.5

2R-BSJ-DC DOUBLE CLEVIS

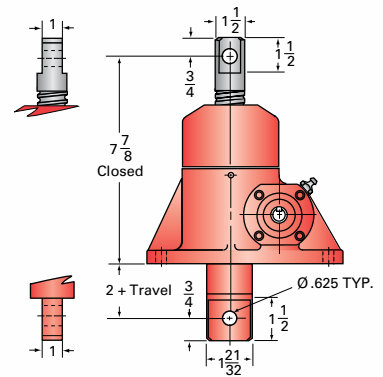

Caution: Jack is self-lowering. Lifting screw must be secured to prevent rotation for non-keyed units.

2R-BSJ-UR UPRIGHT ROTATING

For ordering, specify "L" dimension
L(min) = travel + $7\frac{5}{16}$

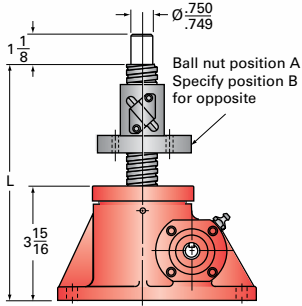

2R-BSJ-IR INVERTED ROTATING

For ordering, specify "L" dimension
L(min) = travel + 4

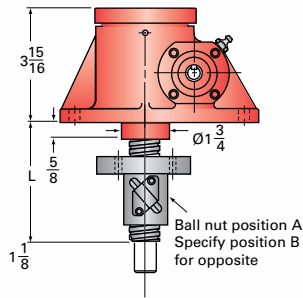

2R-BSJ-UK UPRIGHT KEYED

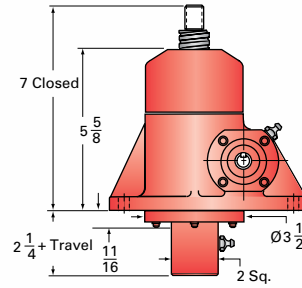

2R-BSJ-IK INVERTED KEYED

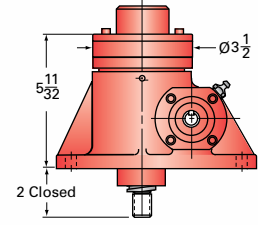

	NON-KEYED			KEYED		
Torque to raise 1 lb (in-lb)	Max Worm Speed at Rated Load (rpm)	Max Load at 1,750 rpm (lb)	Torque to raise 1 lb (in-lb)	Max Worm Speed at Rated Load (rpm)	Max Load at 1,750 rpm (lb)	
.0100	1,800	4,000	.0110	1,636	3,740	
.0064	1,800	4,000	.0070	1,636	3,740	
.0043	1,800	4,000	.0047	1,636	3,740	

2R-BSJ Ball Nut and Flange

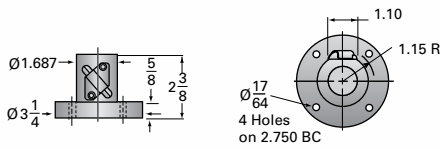

2R-BSJ Options

Top Plate (optional): 9000-00-01

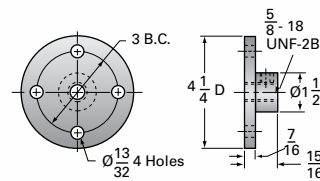

Clevis End (optional): 9001-00-01

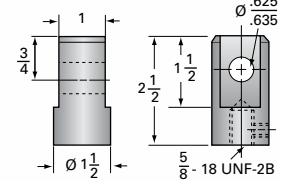

Motor Mount
see pg 180-181

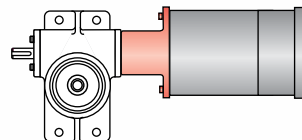

Limit Switch
see pg 196-201

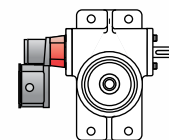

2.5-BSJ

2.5-BSJ TOP VIEW

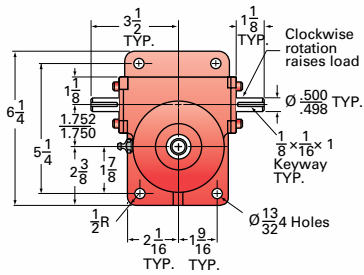

2.5-BSJ-U UPRIGHT

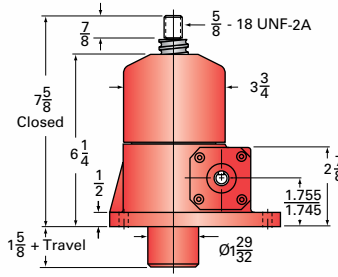

2.5-BSJ-I INVERTED

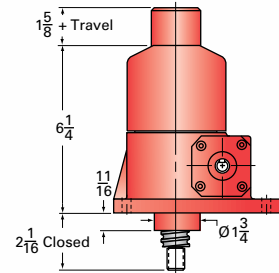

MODEL	Gear Ratio	Turns of Worm for 1" Travel	Max Input Torque (in-lb)	Max Allowable Input (hp)	Tare Drag Torque (in-lb)	Backdrive Holding Torque (ft-lb)
2.5-BSJ	6:1	24	51	2	5	4
Capacity: 2.5 tons Screw: 1000-0250	12:1	48	31	1 1/2	5	2
	24:1	96	21	1/2	5	1.5

Screw Specs:
 Root diameter (in): 0.820
 Start torque = 1.5 x Running Torque
 Approximate weight (lbs)
 "0" Travel: 17
 Per inch travel: 0.6
 Grease: 0.5

2.5-BSJ-DC DOUBLE CLEVIS

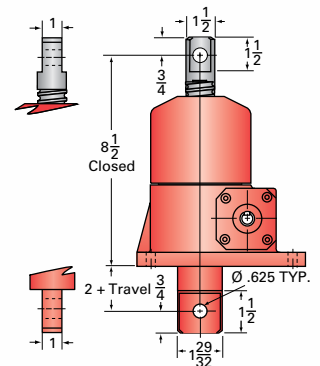

Caution: Jack is self-lowering. Lifting screw must be secured to prevent rotation for non-keyed units.

2.5-BSJ-UR UPRIGHT ROTATING

For ordering, specify "L" dimension
L(min) = travel + $7\frac{3}{16}$

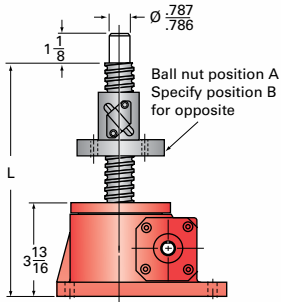

2.5-BSJ-IR INVERTED ROTATING

For ordering, specify "L" dimension
L(min) = travel + $4\frac{1}{16}$

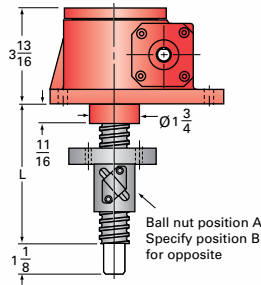

2.5-BSJ-UK UPRIGHT KEYED

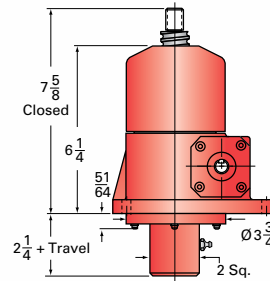

2.5-BSJ-IK INVERTED KEYED

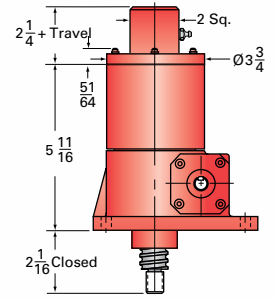

	NON-KEYED			KEYED		
	Torque to raise 1 lb (in-lb)	Max Worm Speed at Rated Load (rpm)	Max Load at 1,750 rpm (lb)	Torque to raise 1 lb (in-lb)	Max Worm Speed at Rated Load (rpm)	Max Load at 1,750 rpm (lb)
	.0102	1,800	5,000	.0112	1,636	4,674
	.0061	1,800	5,000	.0067	1,636	4,674
	.0042	1,500	4,287	.0046	1,370	3,914

2.5-BSJ Ball Nut and Flange

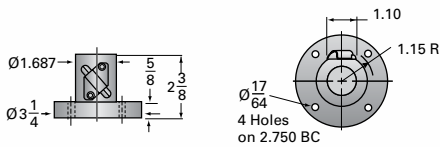

2.5-BSJ Options

Top Plate (optional): 9000-00-01

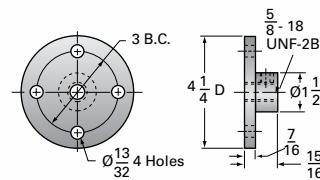

Motor Mount
see pg 180-181

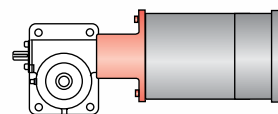

Clevis End (optional): 9001-00-01

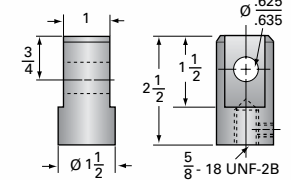

Limit Switch
see pg 196-201

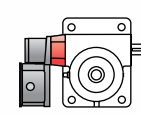

Secondary Reducer
see pg 182-187

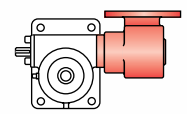

2.5HL-BSJ

2.5HL-BSJ TOP VIEW

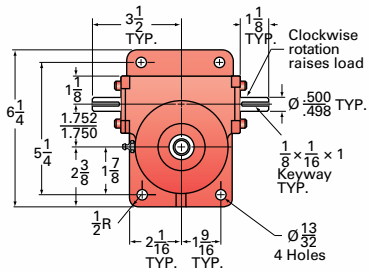

2.5HL-BSJ-U UPRIGHT

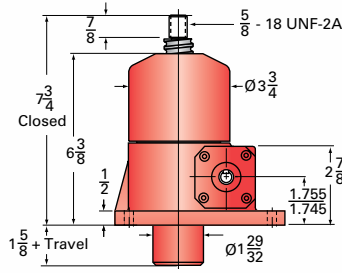

2.5HL-BSJ-I INVERTED

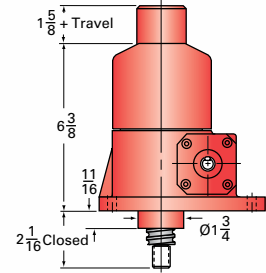

MODEL	Gear Ratio	Turns of Worm for 1" Travel	Max Input Torque (in-lb)	Max Allowable Input (hp)	Tare Drag Torque (in-lb)	Backdrive Holding Torque (ft-lb)
2.5HL-BSJ	6:1	6	202	2	5	14
Capacity: 2.5 tons Screw: 1000-1000	12:1	12	122	1 1/2	5	6
	24:1	24	85	1/2	5	5

Screw Specs:
 Root diameter (in): 0.820
 Drag torque (in-lb): 5
 Start torque = 1.5 × Running Torque
 Approximate weight (lbs)
 "0" Travel: 17
 Per inch travel: 0.6
 Grease: 0.5

2.5HL-BSJ DOUBLE CLEVIS

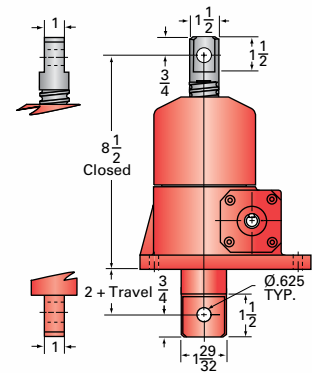

Caution: Jack is self-lowering. Lifting screw must be secured to prevent rotation for non-keyed units.

2.5HL-BSJ-UR UPRIGHT ROTATING

For ordering, specify "L" dimension
L(min) = travel + 7 ²⁷/₃₂

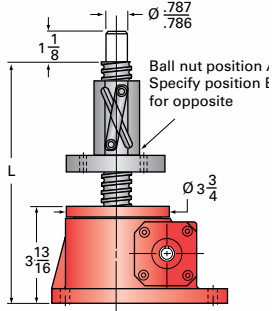

2.5HL-BSJ-IR INVERTED ROTATING

For ordering, specify "L" dimension
L(min) = travel + 4 ²³/₃₂

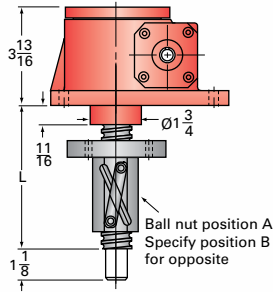

2.5HL-BSJ-UK UPRIGHT KEYED

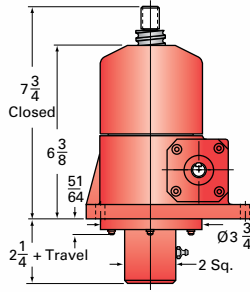

2.5HL-BSJ-IK INVERTED KEYED

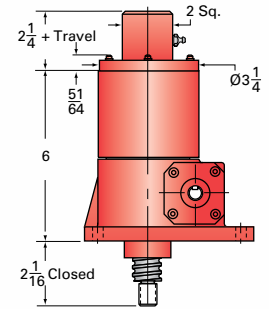

	NON-KEYED			KEYED		
	Torque to raise 1 lb (in-lb)	Max Worm Speed at Rated Load (rpm)	Max Load at 1,750 rpm (lb)	Torque to raise 1 lb (in-lb)	Max Worm Speed at Rated Load (rpm)	Max Load at 1,750 rpm (lb)
	.0404	624	1,783	.0444	567	1,620
	.0244	775	2,214	.0268	705	2,013
	.0170	371	1,059	.0187	337	964

2.5HL-BSJ Ball Nut and Flange

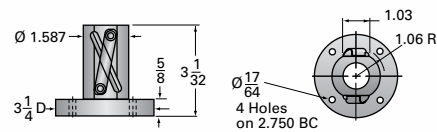

2.5HL-BSJ Options

Top Plate (optional): 9000-00-01

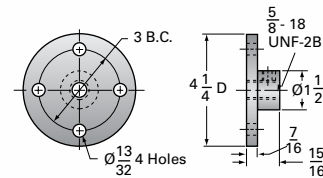

Clevis End (optional): 9001-00-01

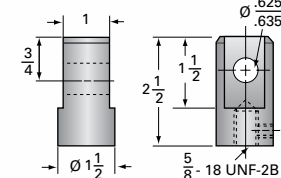

Motor Mount
see pg 180-181

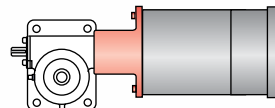

Limit Switch
see pg 196-201

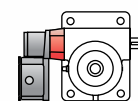

Secondary Reducer
see pg 182-187

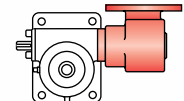

3-BSJ

3-BSJ TOP VIEW

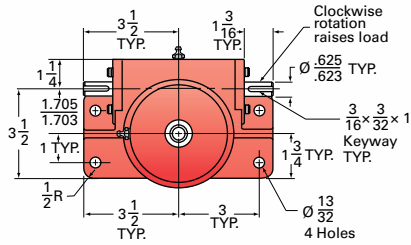

3-BSJ-U UPRIGHT

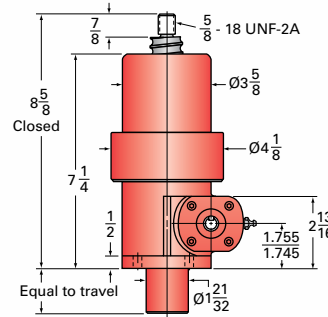

3-BSJ-I INVERTED

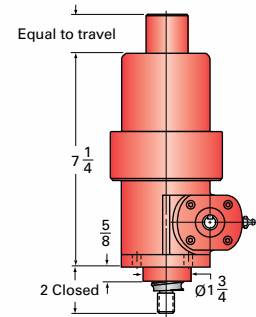

MODEL	Gear Ratio	Turns of Worm for 1" Travel	Max Input Torque (in-lb)	Max Allowable Input (hp)	Tare Drag Torque (in-lb)	Backdrive Holding Torque (ft-lb)
3-BSJ	6:1	14.53	100	2	6	6
Capacity: 3 tons Screw: 1171-0413	24:1	58.10	42	1/2	6	2

Screw Specs:
 Root diameter (in): 0.870
 Start torque = 1.5 x Running Torque
 Approximate weight (lbs)
 "0" Travel: 18.5
 Per inch travel: 0.6
 Grease: 0.5

Caution: Jack is self-lowering. Lifting screw must be secured to prevent rotation for non-keyed units.

3-BSJ-UR UPRIGHT ROTATING

For ordering, specify "L" dimension
L(min) = travel + $8\frac{11}{32}$

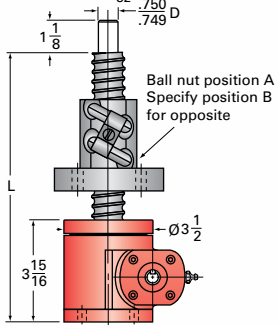

3-BSJ-IR INVERTED ROTATING

For ordering, specify "L" dimension
L(min) = travel + $5\frac{1}{32}$

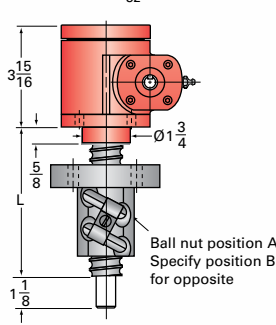

3-BSJ-UK UPRIGHT KEYED

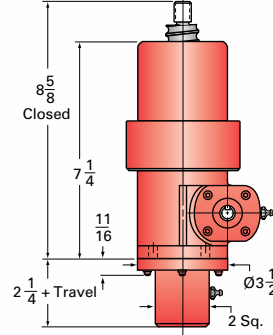

3-BSJ-IK INVERTED KEYED

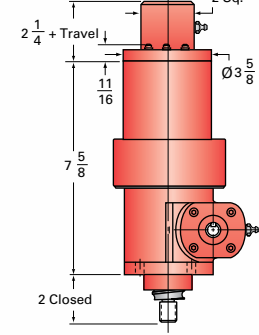

	NON-KEYED			KEYED		
	Torque to raise 1 lb (in-lb)	Max Worm Speed at Rated Load (rpm)	Max Load at 1,750 rpm (lb)	Torque to raise 1 lb (in-lb)	Max Worm Speed at Rated Load (rpm)	Max Load at 1,750 rpm (lb)
	.0167	1,260	4,313	.0184	1,142	3,914.
	.0070	750	2,572	.0077	682	2,338.

3-BSJ Ball Nut and Flange

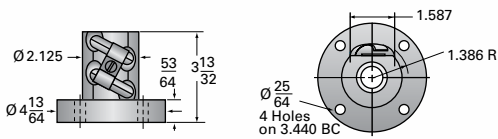

3-BSJ Options

Top Plate (optional): 9000-00-01

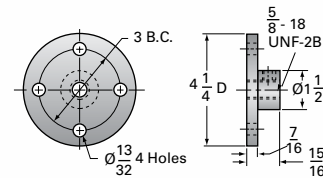

Clevis End (optional): 9001-00-01

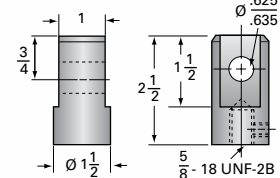

Motor Mount

see pg 180-181

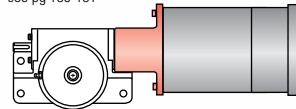

Limit Switch

see pg 196-201

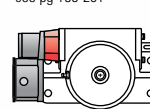

Secondary Reducer

see pg 182-187

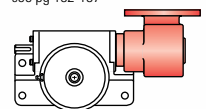

5-BSJ 5HL-BSJ

5-BSJ & 5HL-BSJ TOP VIEW

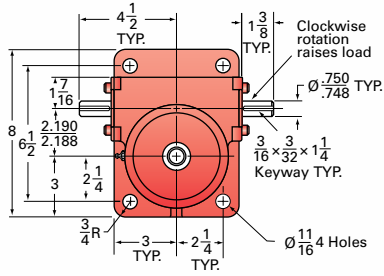

5-BSJ-U & 5HL-BSJ-U UPRIGHT

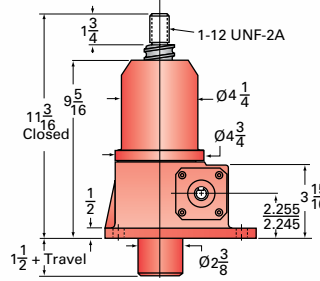

5-BSJ-I & 5HL-BSJ-I INVERTED

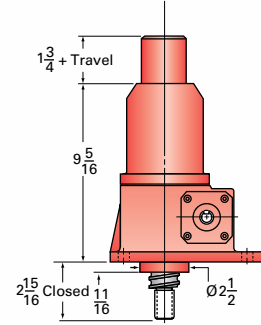

MODEL	Gear Ratio	Turns of Worm for 1" Travel	Max Input Torque (in-lb)	Max Allowable Input (hp)	Tare Drag Torque (in-lb)	Backdrive Holding Torque (ft-lb)
5-BSJ Capacity: 5 tons Screw: 1500-0473	6:1	12.66	183	3	10	14
	24:1	50.66	73	3/4	10	5
5-HL-BSJ Capacity 5 tons Screw: 1500-1000	6:1	6	387	3	10	30
	24:1	24	153	3/4	10	10

Screw Specs:
 Root diameter (in): 1.140
 Start torque = 1.5 x Running Torque
 Approximate weight (lbs)
 "0" Travel: 35
 Per inch travel: 0.6
 Grease: 1

5-BSJ-DC & 5HL-BSJ-DC DOUBLE CLEVIS

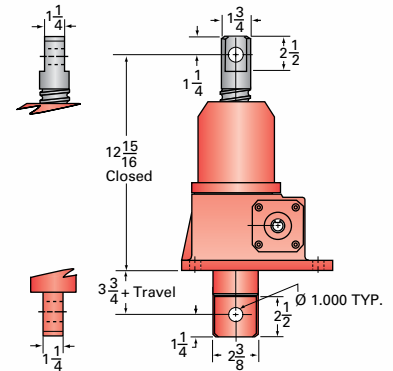

Caution: Jack is self-lowering. Lifting screw must be secured to prevent rotation for non-keyed units.

5-BSJ-UR & 5HL-BSJ-UR
UPRIGHT ROTATING

For ordering, specify "L" dimension
L(min) = travel + $10\frac{1}{16}$

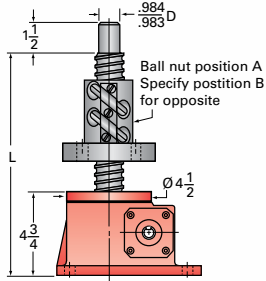

5-BSJ-IR & 5HL-BSJ-IR
INVERTED ROTATING

For ordering, specify "L" dimension
L(min) = travel + 6

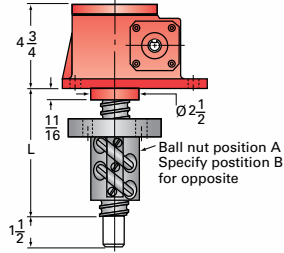

5-BSJ-UK & 5HL-BSJ-UK
UPRIGHT KEYED

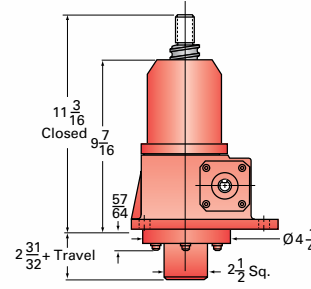

5-BSJ-IK & 5HL-BSJ-IK
INVERTED KEYED

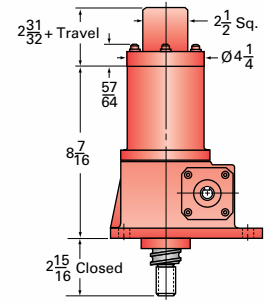

	NON-KEYED			KEYED		
Torque to raise 1 lb (in-lb)	Max Worm Speed at Rated Load (rpm)	Max Load at 1,750 rpm (lb)	Torque to raise 1 lb (in-lb)	Max Worm Speed at Rated Load (rpm)	Max Load at 1,750 rpm (lb)	
.0183	1,033	5,904	.0201	941	5,375	
.0073	547	3,700	.0080	590	3,376	
.0387	498	2,792	.0426	444	2,537	
.0153	308	1,765	.0168	280	1,600	

5-BSJ Ball Nut and Flange

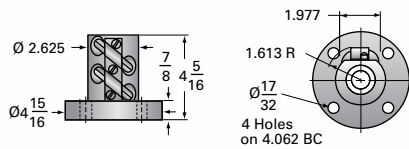

5HL-BSJ Ball Nut and Flange

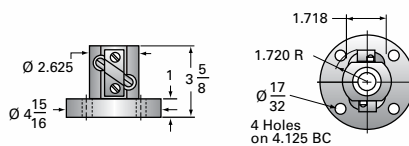

5-BSJ & 5HL-BSJ Options

Top Plate (optional): 9000-00-02

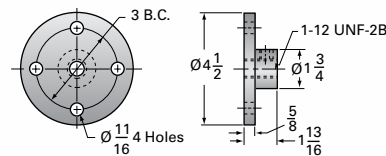

Clevis End (optional): 9001-00-02

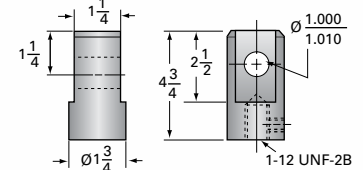

Motor Mount
see pg 180-181

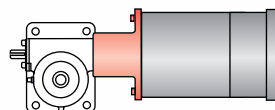

Limit Switch
see pg 196-201

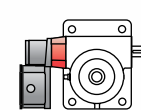

Secondary Reducer
see pg 182-187

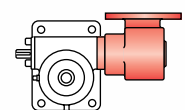

10-BSJ 10HL-BSJ

10-BSJ & 10HL-BSJ TOP VIEW

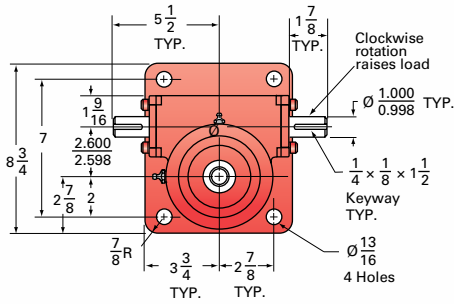

10-BSJ-U & 10HL-BSJ-U UPRIGHT

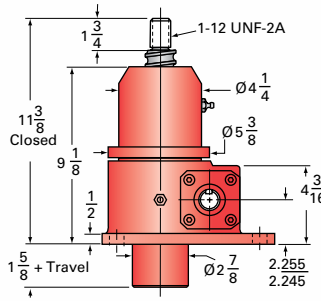

10-BSJ-I & 10HL-BSJ-I INVERTED

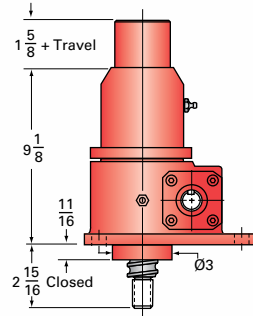

MODEL	Gear Ratio	Turns of Worm for 1" Travel	Max Input Torque (in-lb)	Max Allowable Input (hp)	Tare Drag Torque (in-lb)	Backdrive Holding Torque (ft-lb)
10-BSJ Capacity: 10 tons Screw: 1500-0473	8:1	16.88	302	5	20	13
	24:1	50.66	153	1 1/2	20	4
10-HL-BSJ Capacity 10 tons Screw: 1500-1000	8:1	8	638	5	20	26
	24:1	24	323	1 1/2	20	6

Screw Specs:
 Root diameter (in): 1.140
 Start torque = 1.5 x Running Torque
 Approximate weight (lbs)
 "0" Travel: 50
 Per inch travel: 0.8
 Grease: 1.5

10-BSJ-DC & 10HL-BSJ-DC DOUBLE CLEVIS

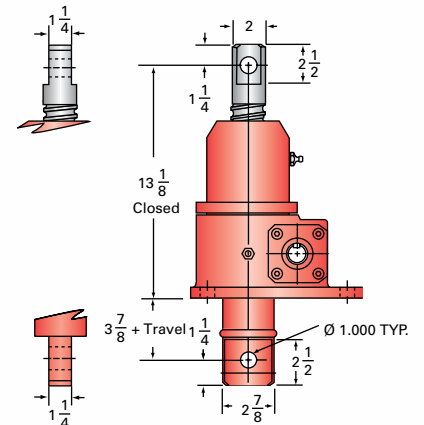

Caution: Jack is self-lowering. Lifting screw must be secured to prevent rotation for non-keyed units.

10-BSJ-UR & 10HL-BSJ-UR
UPRIGHT ROTATING

For ordering, specify "L" dimension
L(min) = travel + $10 \frac{3}{16}$

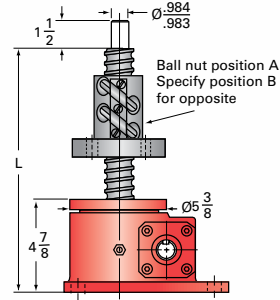

10-BSJ-IR & 10HL-BSJ-IR
INVERTED ROTATING

For ordering, specify "L" dimension
L(min) = travel + 6

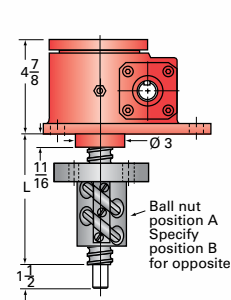

10-BSJ-IK & 10HL-BSJ-IK
UPRIGHT KEYED

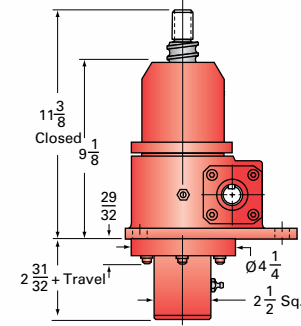

10-BSJ-IK & 10HL-BSJ-IK
INVERTED KEYED

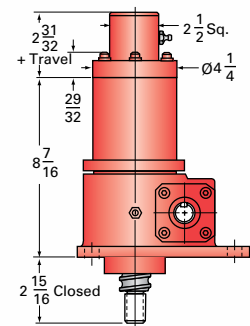

Torque to raise 1 lb (in-lb)	NON-KEYED		KEYED		Torque to raise 1 lb (in-lb)
	Max Worm Speed at Rated Load (rpm)	Max Load at 1,750 rpm (lbs)	Max Worm Speed at Rated Load (rpm)	Max Load at 1,750 rpm (lbs)	
.0151	1,043	11,925	.0166	949	10,847
.0077	618	7,016	.0085	556	6,355
.0319	494	5,645	.0351	449	5,132
.0162	293	3,334	.0178	266	3,044

10-BSJ Ball Nut and Flange

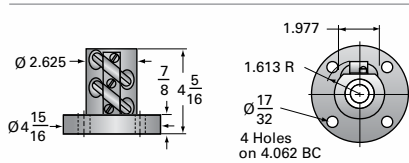

10-BSJ & 10HL-BSJ Options

Top Plate (optional): 9000-00-04

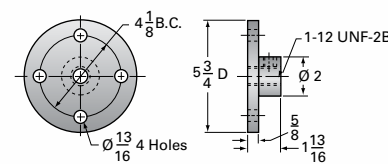

Clevis End (optional): 9001-00-04

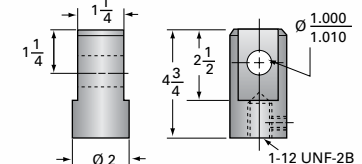

10HL-BSJ Ball Nut and Flange

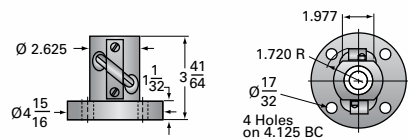

Motor Mount
see pg 180-181

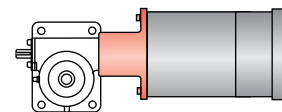

Limit Switch
see pg 196-201

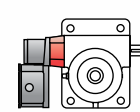

Secondary Reducer
see pg 182-187

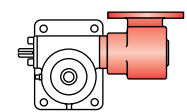

20-BSJ 20HL-BSJ

**20-BSJ & 20HL-BSJ
TOP VIEW**

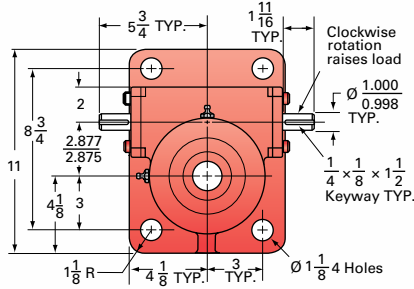

**20-BSJ-U & 20HL-BSJ-U
UPRIGHT**

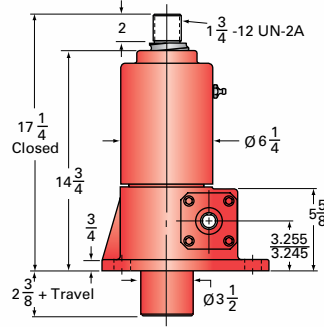

**20-BSJ-I & 20HL-BSJ-I
INVERTED**

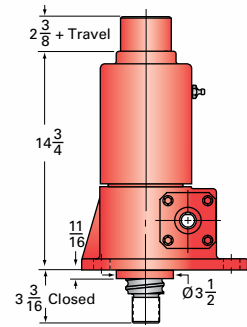

MODEL	Gear Ratio	Turns of Worm for 1" Travel	Max Input Torque (in-lb)	Max Allowable Input (hp)	Tare Drag Torque (in-lb)	Backdrive Holding Torque (ft-lb)
20-BSJ Capacity: 20 tons Screw: 2250-0500	8:1	16	626	7 1/2	40	27
	24:1	48	314	2 1/2	40	7
20-HL-BSJ Capacity 20 tons Screw: 22250-1000	8:1	8	1,253	7 1/2	40	54
	24:1	24	628	2 1/2	40	13

Screw Specs:
 Root diameter (in): 1.850
 Start torque = 1.5 x Running Torque
 Approximate weight (lbs)
 "0" Travel: 85
 Per inch travel: 1.5
 Grease: 2.2

Caution: Jack is self-lowering. Lifting screw must be secured to prevent rotation for non-keyed units.

20-BSJ-UR & 20HL-BSJ-UR
UPRIGHT ROTATING

For ordering, specify "L" dimension
L(min) = travel + 14 1/2

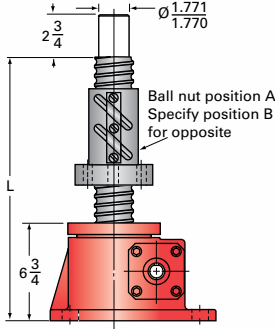

20-BSJ-IR & 20HL-BSJ-IR
INVERTED ROTATING

For ordering, specify "L" dimension
L(min) = travel + 8 7/16

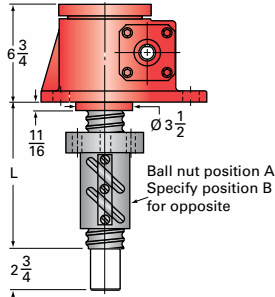

20-BSJ-UK & 20HL-BSJ-UK
UPRIGHT KEYED

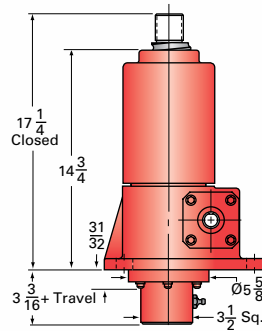

20-BSJ-IK & 20HL-BSJ-IK
INVERTED KEYED

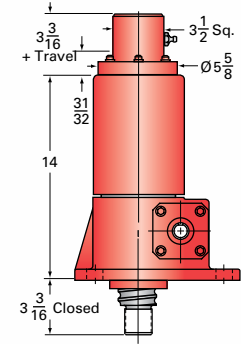

BALL SCREW JACKS

NON-KEYED			KEYED		
Torque to raise 1 lb (in-lb)	Max Worm Speed at Rated Load (rpm)	Max Load at 1,750 rpm (lb)	Torque to raise 1 lb (in-lb)	Max Worm Speed at Rated Load (rpm)	Max Load at 1,750 rpm (lb)
.0157	755	17,204	.0173	683	15,613
.0079	501	11,397	.0087	453	10,349
.0313	377	8,629	.0344	343	7,840
.0157	251	5,737	.0173	228	5,211

20-BSJ Ball Nut and Flange

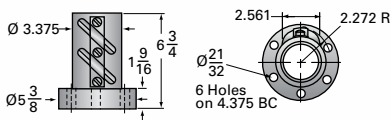

20HL-BSJ Ball Nut and Flange

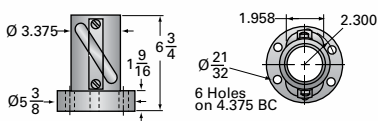

20-BSJ & 20HL-BSJ Options

Top Plate (optional): 9000-00-06

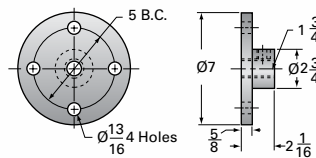

Clevis End (optional): 9001-00-06

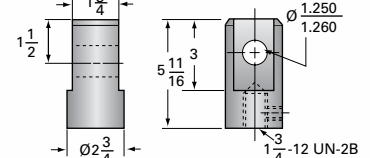

Motor Mount
see pg 180-181

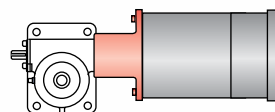

Limit Switch
see pg 196-201

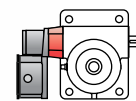

Secondary Reducer
see pg 182-187

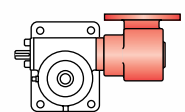

2D/3D CAD ONLINE

nookindustries.com

30-BSJ 30HL-BSJ

**30-BSJ & 30HL-BSJ
TOP VIEW**

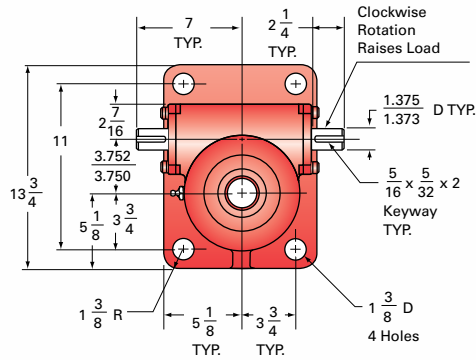

**30-BSJ-U & 30HL-BSJ-U
UPRIGHT**

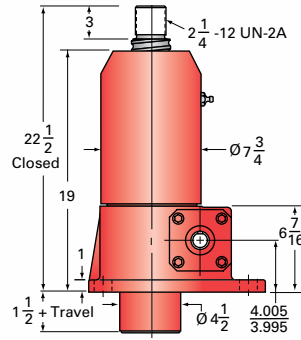

**30-BSJ-I & 30HL-BSJ-I
INVERTED**

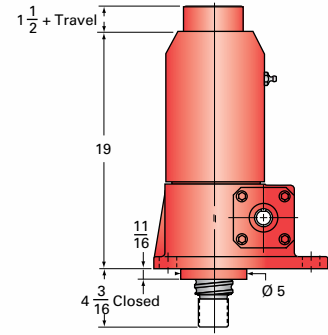

MODEL	Gear Ratio	Turns of Worm for 1" Travel	Max Input Torque (in-lb)	Max Allowable Input (hp)	Tare Drag Torque (in-lb)	Backdrive Holding Torque (ft-lb)
30-BSJ Capacity: 30 tons Screw: 3000-0660	10 ³ / ₅ :1	16.16	989	11	60	21
	32:1	48.48	503	3 1/2	60	5
30HL-BSJ Capacity 30 tons Screw: 3000-1500	10 ³ / ₅ :1	7.11	2,292	11	60	67
	32:1	21.33	1,144	3 1/2	60	15

Screw Specs:
 Root diameter (in): 2.480
 Start torque = 1.5 x Running Torque
 Approximate weight (lbs)
 "0" Travel: 220
 Per inch travel: 2.4
 Grease: 3.5

Caution: Jack is self-lowering. Lifting screw must be secured to prevent rotation for non-keyed units.

30-BSJ-UR & 30HL-BSJ-UR
UPRIGHT ROTATING

For ordering, specify "L" dimension
L(min) = travel + 18 ³/₈

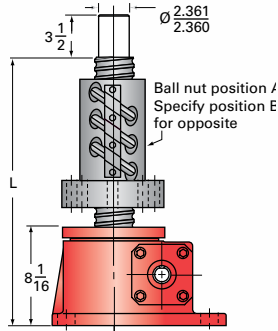

30-BSJ-IR & 30HL-BSJ-IR
INVERTED ROTATING

For ordering, specify "L" dimension
L(min) = travel + 11

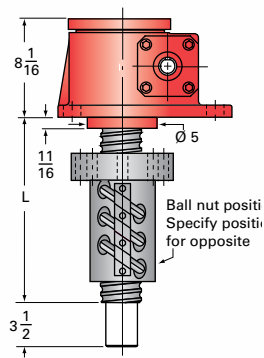

30-BSJ-UK & 30HL-BSJ-UK
UPRIGHT KEYED

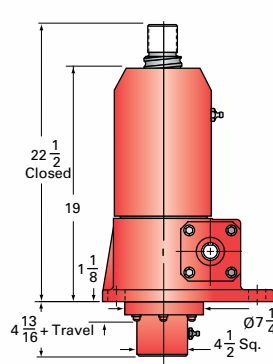

30-BSJ-IK & 30HL-BSJ-IK
INVERTED KEYED

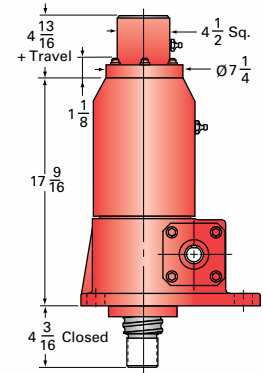

BALL SCREW JACKS

Torque to raise 1 lb (in-lb)	NON-KEYED		KEYED	
	Max Worm Speed at Rated Load (rpm)	Max Load at 1,750 rpm (lb)	Torque to raise 1 lb (in-lb)	Max Worm Speed at Rated Load (rpm)
.0162	715	24,515	.0178	649
.0084	438	15,006	.0092	399
.0367	315	10,794	.0404	286
.0191	193	6,600	.0210	175

30-BSJ Ball Nut and Flange

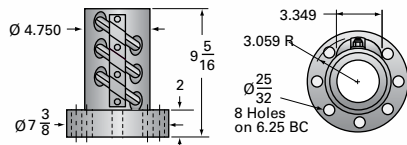

30HL-BSJ Ball Nut and Flange

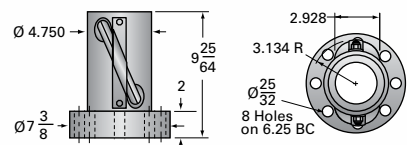

30-BSJ & 30HL-BSJ Options

Top Plate (optional): 9000-00-08

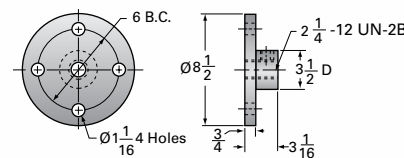

Clevis End (optional): 9001-00-07

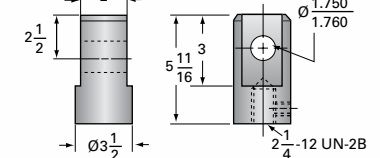

Motor Mount
see pg 180-181

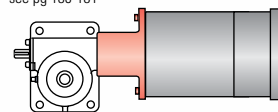

Limit Switch
see pg 196-201

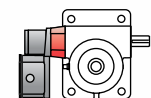

50-BSJ

50-BSJ TOP VIEW

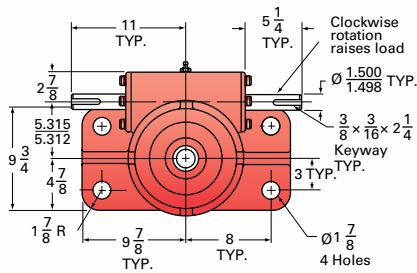

50-BSJ-U UPRIGHT

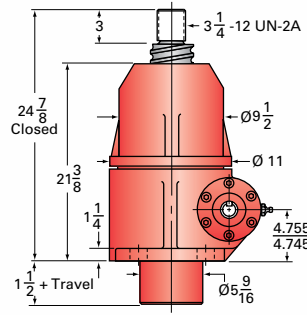

50-BSJ-I INVERTED

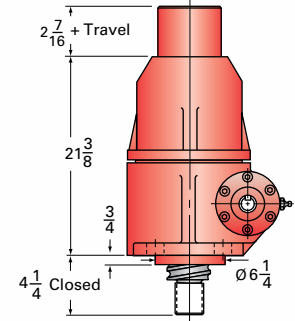

MODEL	Gear Ratio	Turns of Worm for 1" Travel	Max Input Torque (in-lb)	Max Allowable Input (hp)	Tare Drag Torque (in-lb)	Backdrive Holding Torque (ft-lb)
50-BSJ	10%:1	10.66	2,560	16	90	40
Capacity: 50 tons Screw: 4000-1000						
	32:1	32	1,390	5	90	10

Screw Specs:
 Root diameter (in): 3.338
 Start torque = 1.5 × Running Torque
 Approximate weight (lbs)
 "0" Travel: 490
 Per inch travel: 5.0
 Grease: 5.0

Caution: Jack is self-lowering. Lifting screw must be secured to prevent rotation for non-keyed units.

50-BSJ-UR UPRIGHT ROTATING

For ordering, specify "L" dimension
L(min) = travel + 24 1/2

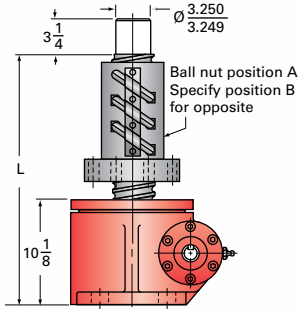

50-BSJ-IR INVERTED ROTATING

For ordering, specify "L" dimension
L(min) = travel + 14 3/8

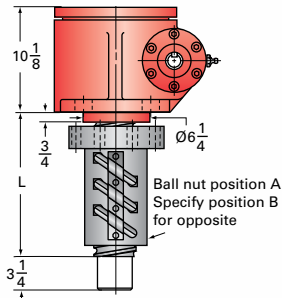

50-BSJ-UK UPRIGHT KEYED

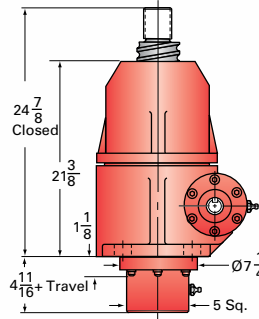

50-BSJ-IK INVERTED KEYED

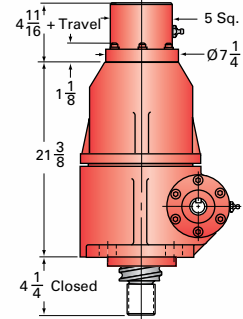

NON-KEYED			KEYED		
Torque to Raise 1 lb (in-lb)	Max Worm Speed at Rated Load (rpm)	Max Load at 1,750 rpm (lb)	Torque to Raise 1 lb (in-lb)	Max Worm Speed at Rated Load (rpm)	Max Load at 1,750 rpm (lb)
.0256	394	22,509	.0281	359	20,506
.0139	227	12,955	.0152-	207	11,847

50-BSJ Ball Nut and Flange

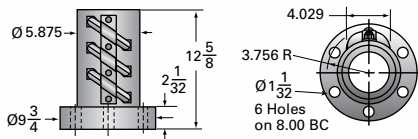

50-BSJ Options

Top Plate (optional): 9000-00-09

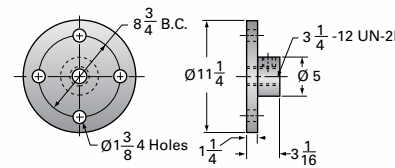

Clevis End (optional): 9001-00-09

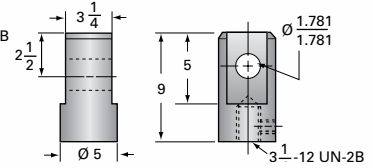

Limit Switch
see pg 196-201

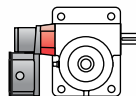

75-BSJ

75-BSJ TOP VIEW

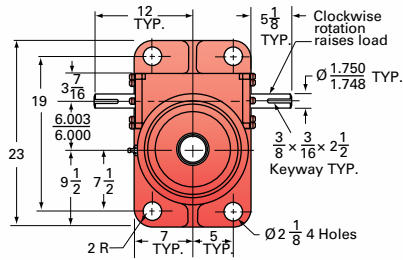

75-BSJ-U UPRIGHT

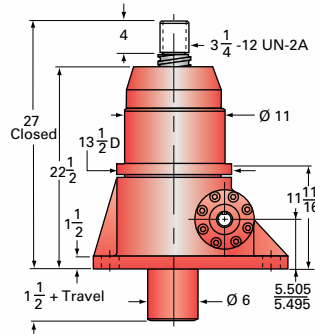

75-BSJ-I INVERTED

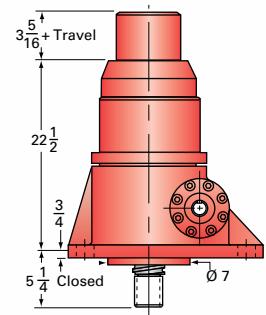

MODEL	Gear Ratio	Turns of Worm for 1" Travel	Max Input Torque (in-lb)	Max Allowable Input (hp)	Tare Drag Torque (in-lb)	Backdrive Holding Torque (ft-lb)
75-BSJ	10 2/3:1	10.66	3,660	28	155	110
Capacity: 75 tons Screw: 4000-1000						
	32:1	32	1,680	9	155	25

Screw Specs:
 Root diameter (in): 3.338
 Start torque = 1.5 × Running Torque
 Approximate weight (lbs)
 "0" Travel: 650
 Per inch travel: 5.0
 Grease: 9.0

Caution: Jack is self-lowering. Lifting screw must be secured to prevent rotation for non-keyed units.

75-BSJ-UR UPRIGHT ROTATING

For ordering, specify "L" dimension
L(min) = travel + 27 ⁵/₁₆

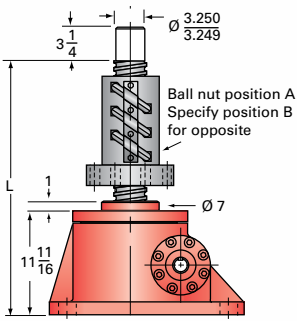

75-BSJ-IR INVERTED ROTATING

For ordering, specify "L" dimension
L(min) = travel + 15 ³/₈

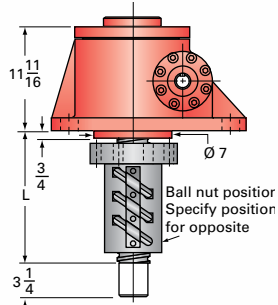

75-BSJ-UK UPRIGHT KEYED

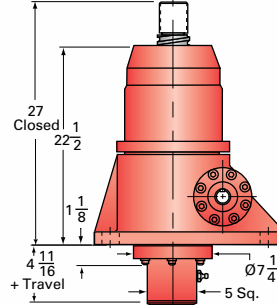

75-BSJ-UK INVERTED KEYED

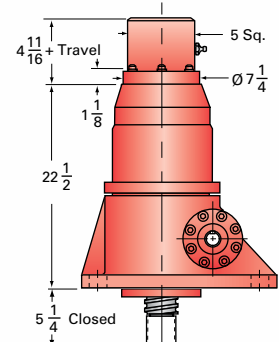

	NON-KEYED			KEYED		
	Torque to Raise 1 lb (in-lb)	Max Worm Speed at Rated Load (rpm)	Max Load at 1,750 rpm (lb)	Torque to Raise 1 lb (in-lb)	Max Worm Speed at Rated Load (rpm)	Max Load at 1,750 rpm (lb)
	.0244	482	41,326	.0268	439	37,627
	.0112	338	28,970	.0123	307	26,352

75-BSJ Ball Nut and Flange

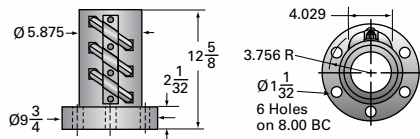

75-BSJ Options

Top Plate (optional): 9000-00-18

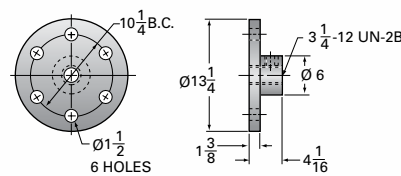

Clevis End (optional): 9001-00-18

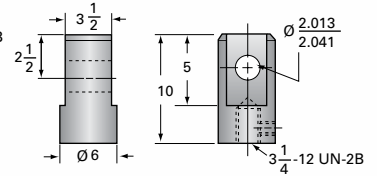

Limit Switch

see pg 196-201

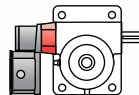

100-BSJ

100-BSJ TOP VIEW

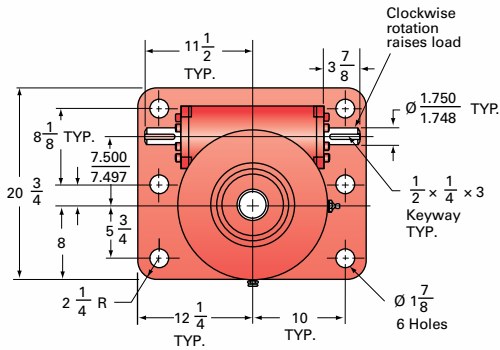

100-BSJ-U UPRIGHT

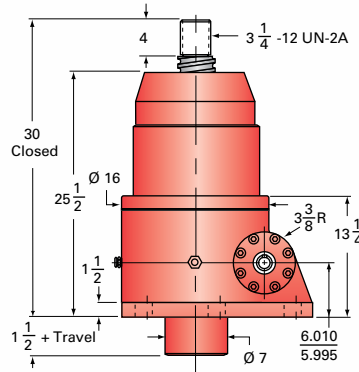

100-BSJ-I INVERTED

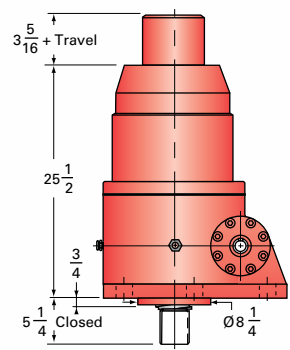

MODEL	Gear Ratio	Turns of Worm for 1" Travel	Max Input Torque (in-lb)	Max Allowable Input (hp)	Tare Drag Torque (in-lb)	Backdrive Holding Torque (ft-lb)
100-BSJ	10%:1	10.66	4,880	32	205	152
Capacity: 100 tons Screw: 4000-1000						
	32:1	32	2,760	12 1/2	205	25

Screw Specs:
 Root diameter (in): 3.338
 Start torque = 1.5 x Running Torque
 Approximate weight (lbs)
 "0" Travel: 1100
 Per inch travel: 5.0
 Grease: 16.0

Caution: Jack is self-lowering. Lifting screw must be secured to prevent rotation for non-keyed units.

100-BSJ-UR UPRIGHT ROTATING

For ordering, specify "L" dimension
L(min) = travel + $29\frac{3}{8}$

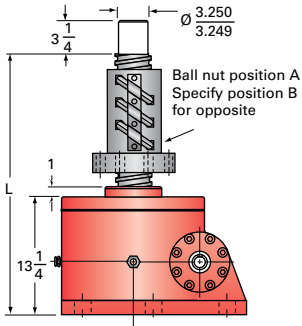

100-BSJ-IR INVERTED ROTATING

For ordering, specify "L" dimension
L(min) = travel + $15\frac{7}{8}$

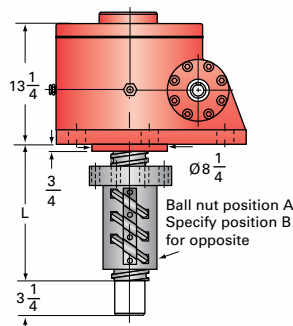

NON-KEYED			KEYED		
Torque to Raise 1 lb (in-lb)	Max Worm Speed at Rated Load (rpm)	Max Load at 1,750 rpm (lb)	Torque to Raise 1 lb (in-lb)	Max Worm Speed at Rated Load (rpm)	Max Load at 1,750 rpm (lb)
.0244	413	47,232	-	-	-
.0138	285	32,621	-	-	-

100-BSJ Ball Nut and Flange

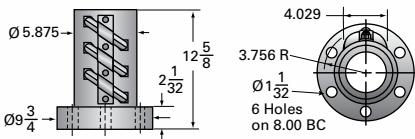

100-BSJ Options

Top Plate (optional): 9000-00-19

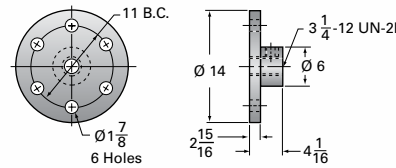

Clevis End (optional): 9001-00-19

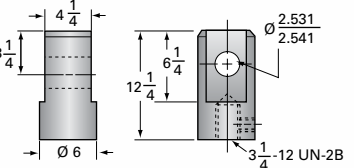

Limit Switch

see pg 196-201

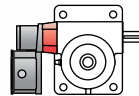

MACHINE SCREW JACKS

The worm gear driven Machine Screw Jack incorporates an alloy steel worm which drives a high strength bronze worm gear (drive sleeve). The worm shaft is supported on anti-friction tapered roller bearings with external seals provided to prevent loss of lubrication*. The drive sleeve is supported on anti-friction tapered roller or ball thrust bearings. Rotation of the drive sleeve causes the acme thread lifting screw to translate or rotate, depending upon jack configuration.

The jack housing is made of ductile iron** and proportioned to support the rated capacity of the unit. The lifting screw is made of alloy steel with a minimum tensile strength of 95,000 psi. The threads are precision formed, typically using Class 2-C (Centralizing) tolerances. Jack lift shaft lead tolerance is approximately ± 0.004 " per foot.

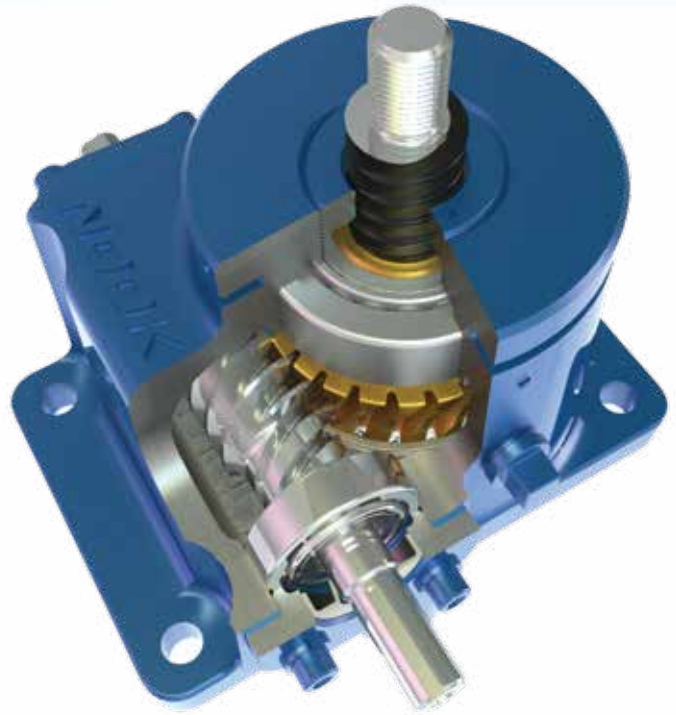

* sealed radial bearings on the MJ and 1 ton units

** MJ models have aluminum housings, aluminum optional on one ton models



Nook/Thomson machine screw jacks used in a satellite dish application .

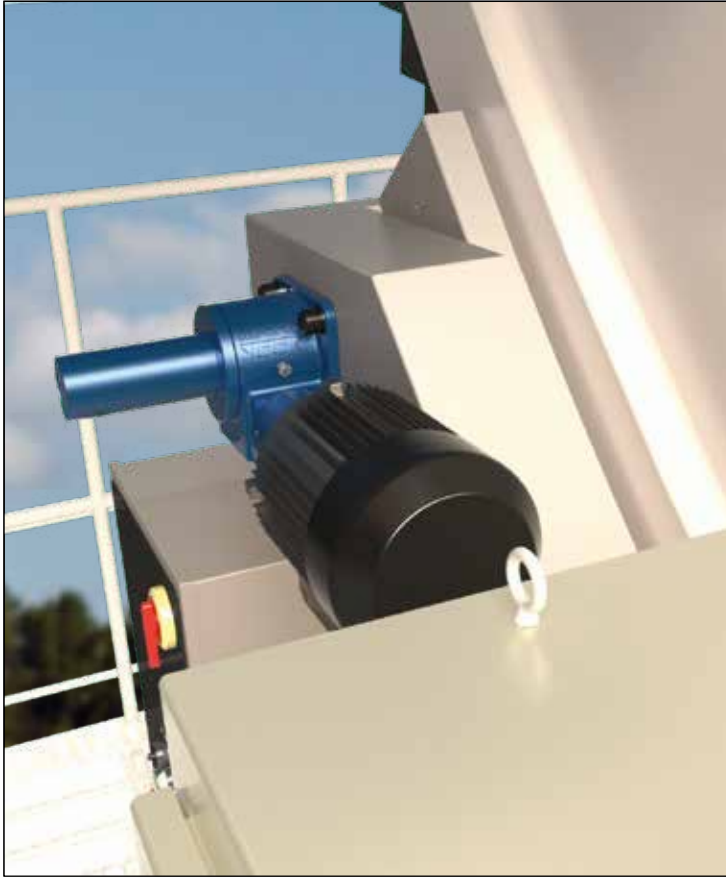

MACHINE SCREW JACKS62-69

.....PowerAc™ Precision Acme Screws
 64-65
 Quick Reference
 66-67
 Column Strength
 68
 Reference Number System
 69

TECHNICAL DATA70-97

..... Mini Jacks
 70-71
 1-MSJ
 72-73
 2-MSJ
 74-75
 2R-MSJ
 76-77
 2.5-MSJ
 78-79
 5-MSJ
 80-81
 10-MSJ
 82-83
 15-MSJ
 84-85
 20-MSJ
 86-87
 30-MSJ
 88-89
 35-MSJ
 90-91
 50-MSJ
 92-93
 75-MSJ
 94-95
 100-MSJ
 96-97

MACHINE SCREW JACKS

ACME SCREW TECHNICAL INFORMATION

Nook/Thomson Machine Screw Jacks are fitted with our own PowerAc™ Acme Lead Screws and Nuts. Nook/Thomson manufactures PowerAc™ precision acme screws by thread rolling for ActionJac™ Worm Gear Machine Screw Jacks, a process that produces high-precision screws. Nook/Thomson Acme Screw products feature centralizing thread forms for smooth, no-wedging performance.

STRAIGHTNESS - PowerAc™ Acme Lead Screws are straight within .010 inch/foot when shipped from the factory, and do not exceed .030 inch in any 6 foot section.

Material	Surface	Lead Accuracy	Screw Dia.	Screw Lengths
Alloy	black	± .0003"/" up to 1½" dia.	¼" to 1½"	Limited only by material availability
Stainless	steel	± .0003"/" up to 1½" dia.	¼" to 1½"	Limited only by material availability

BACKLASH - Backlash (lash) is the relative axial movement between a screw and nut without rotation of the screw or nut. The axial movement between a new PowerAc™ acme nut and screw will range from .003" to .015" depending on size. Lash in ball screws will remain constant during normal use.

LOAD DEFINITIONS

CAPACITY - The maximum thrust load – including shock – that can be applied to the nut without damaging the assembly.

TENSION LOAD - A load that tends to “stretch” the screw. (See FIG. 1)

COMPRESSION LOAD - A load that tends to “squeeze” the screw. (See FIG. 1)



Nook/Thomson machine screw jacks are used in large material transfer applications.

FIG. 1

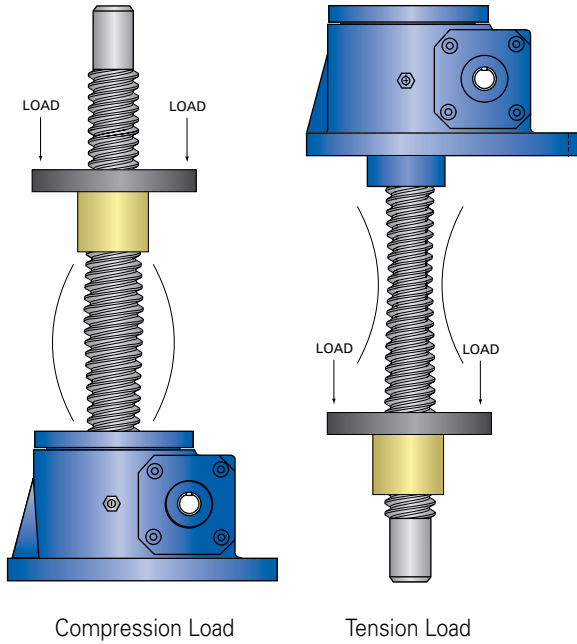

OVERTURNING LOAD - A load that tends to rotate the nut radially around the longitudinal axis of the screw. (See FIG. 2)

SIDE LOAD - A load that is applied radially to the nut. (See FIG. 2)

CAUTION - Although a side load will not prevent the lead screw from operating, the nut is not designed to operate with a side load, such as those generated from pulleys, drive belts, misalignment, etc.

THRUST LOAD - A load parallel to and concentric with the axis of the screw. (See FIG. 2)

FIG. 2

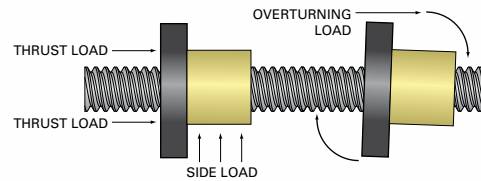

Nook/Thomson machine screw jacks are used in solar applications.

QUICK REFERENCE

MACHINE SCREW JACKS

MODEL	Gear Ratio	Capacity (tons)	Lifting Screw Dia (in)	Screw Lead (in)	Root Dia (in)	Turns of Worm for 1" Travel	Max Input Torque (in.-lb.)	Max Input (hp)	Max Worm Speed at Rated Load (rpm)	Max Load at 1,750 rpm (lb)	Torque to Raise 1 lb. (in.-lb)	Lift Shaft Eff. (%)	Tare Drag Torque (in.-lb)
1-MSJ	5:1	1	¾	.200	.502	25	45	½	700	800	.0225	40	3
	20:1	1	¾	.200	.502	100	21	¼	750	857	.0105	40	3
2-MSJ	6:1	2	1	.250	.698	24	100	2	1,260	2,881	.0250	38	4
	12:1	2	1	.250	.698	48	62	1½	1,525	3,456	.0154	38	4
	24:1	2	1	.250	.698	96	42	½	750	1,715	.0105	38	4
2R-MSJ	6:1	2	1	.250	.698	24	100	2	1,260	2,881	.0250	38	4
	12:1	2	1	.250	.698	48	62	1½	1,525	3,486	.0154	38	4
	24:1	2	1	.250	.698	96	42	½	750	1,715	.0105	38	4
2.5-MSJ	6:1	2½	1	.250	.698	24	126	2	1,000	2,858	.0252	38	5
	12:1	2½	1	.250	.698	48	74	1½	1,277	3,650	.0148	38	5
	24:1	2½	1	.250	.698	96	53	½	594	1,699	.0106	38	5
5-MSJ	6:1	5	1½	.375	1.066	16	376	3	500	2,873	.0376	40	10
	24:1	5	1½	.375	1.066	64	144	¾	330	1,875	.0144	40	10
10-MSJ	8:1	10	2	.500	1.410	16	753	5	418	4,766	.0377	40	20
	24:1	10	2	.500	1.410	48	384	1½	246	2,813	.0192	40	20
15-MSJ	8:1	15	2¼	.500	1.684	16	1,221	5	258	4,424	.0407	37	20
	24:1	15	2¼	.500	1.684	48	654	1½	144	2,478	.0218	37	20
20-MSJ	8:1	20	2½	.500	1.908	16	1,740	7½	272	6,209	.0435	34	40
	24:1	20	2½	.500	1.908	48	873	2½	180	4,130	.0218	34	40
30-MSJ	10¾:1	30	3⅝	.667	2.652	16	2,710	11	256	8,764	.0452	34	50
	32:1	30	3⅝	.667	2.652	48	1,411	3½	156	5,364	.0235	34	50
35-MSJ	10¾:1	35	3¾	.667	3.009	16	3,450	11	200	8,035	.0493	30	50
	32:1	35	3¾	.667	3.009	48	1,800	3½	122	4,904	.0257	30	50
50-MSJ	10¾:1	50	4½	.667	3.782	16	5,555	16	181	10,382	.0555	28	100
	32:1	50	4½	.667	3.782	48	3,014	5	104	5,982	.0301	28	100
75-MSJ	10¾:1	75	5	.667	4.286	16	8,236	28	214	18,368	.0549	26	155
	32:1	75	5	.667	4.286	48	3,780	9	150	12,862	.0252	26	155
100-MSJ	10¾:1	100	6	.667	5.254	16	13,166	32	153	17,330	.0665	22	205
	32:1	100	6	.667	5.254	48	7,460	12½	106	11,941	.0377	22	205

NOTES:

- 1) The recommended maximum speed is 1,800 rpm provided that the recommended horsepower and temperature are not exceeded.
- 2) Input torque is shown as torque to lift one pound of load. Starting Torque is 100% greater than torque shown. For loads less than 25% of rated loads add tare drag torque.
- 3) Maximum allowable horsepower ratings are based on a 25% duty cycle at standard ambient temperature, with 1 minute on 3 minute off cycles. For operation at higher duty cycles or repeated use over any segment of the total travel, temperature must be monitored and remain less than 200°F.

4) Overload capacity of the Machine Screw Jack is as follows: 10% for dynamic loads, 30% for static loads.

5) Machine Screw Jacks with gear ratios between 20:1 and 32:1, or where the lift shaft efficiency less than 35%, may be considered self-locking and will hold loads without backdriving in the absence of vibration. All other ratios and lift shaft efficiencies may require a brake to prevent backdriving.

CAUTION - Vibration can cause any Jack assembly to creep or backdrive. When using any jack assembly, applications should be analyzed to determine the necessity of a brake, especially when the possibility of injury may occur.

QUICK REFERENCE

MINI JACKS

MODEL	Gear Ratio	Capacity (tons)	Lifting Screw Dia (in)	Screw Lead (in)	Root Dia (in)	Turns of Worm for 1" Travel	Max Input Torque (in.-lb.)	Max Input (hp)	Max Worm Speed at Rated Load (rpm)	Max Load at 1,750 rpm (lb)	Torque to Raise 1 lb. (in.-lb)	Lift Shaft Eff. (%)	Tare Drag Torque (in.-lb)
MJ-20	5:1	.5	½	.250	.332	20	19	⅓	1,090	631	.019	57	—
MJ-25	5:1	.5	⅝	.200	.377	25	21	⅓	1,040	571	.021	44	—
MJ-40	5:1	.5	⅝	.125	.457	40	17	⅓	1,260	706	.017	34	—
MJ-50	5:1	.5	½	.100	.359	50	14	⅓	1,560	857	.014	34	—
MJ-80	20:1	.5	½	.250	.332	80	8	⅙	1,310	750	.008	57	—
MJ-100	20:1	.5	⅝	.200	.377	100	9	⅙	1,210	667	.009	44	—
MJ-160	20:1	.5	⅝	.125	.457	160	7	⅙	1,500	857	.007	34	—
MJ-200	20:1	.5	½	.100	.359	200	6	⅙	1,800	1,000	.006	34	—

QUICK REFERENCE

NUMERIC RATIO JACKS

ActionJac™ Anti-backlash Machine Screw Jacks may be ordered with worm gear sets and lift shafts specifically designed to provide 0.01 inch of travel for each revolution of the input shaft. Referred to as "Numeric Ratio" jack, these units are usually manually operated to precisely position machine components such as end stops or calender rolls.

These jacks can be supplied with handwheels and counters (see ActionJac™ accessories section) to provide immediate positional feedback to an operator. ActionJac™ Numeric Ratio Anti-backlash Machine Screw Jacks retain all the performance characteristics of standard machine screw jacks.

MODEL	Gear Ratio	Capacity (tons)	Lifting Screw Dia (in)	Screw Lead (in)	Root Dia (in)	Turns of Worm for 1" Travel	Max Input Torque (in.-lb.)	Max Input (hp)	Max Worm Speed at Rated Load (rpm)	Max Load at 1,750 rpm (lb)	Torque to Raise 1 lb. (in.-lb)	Tare Drag Torque (in.-lb)
MJAB-100	20:1	½	0.625	0.200	0.377	100	8.7	0.17	1,210	690	0.009	1.0
1AB-MSJ	20:1	1	0.750	0.200	0.502	100	21	0.26	750	855	0.011	3.0
2AB-MSJ	25:1	2	1.000	0.250	0.698	100	41	0.51	780	1,780	0.010	4.0
2.5AB-MSJ	25:1	2.5	1.000	0.250	0.698	100	51	0.51	625	1,785	0.010	5.0
5AB-MSJ	25:1	5	1.500	0.250	1.196	100	116	0.67	365	2,085	0.012	10.0
10AB-MSJ	25:1	10	2.000	0.250	1.694	100	309	1.38	282	3,225	0.015	20.0
15AB-MSJ	25:1	15	2.250	0.250	1.944	100	505	1.33	165	2,835	0.017	20.0
20AB-MSJ	25:1	20	2.500	0.250	2.193	100	712	2.32	205	4,690	0.018	40.0

NOTES (CONT'D):

6) All units are suitable for intermittent operation providing that the housing temperature including ambient is not lower than -20°F or higher than +200°F. Factory supplied grease in standard units will operate in this range. For higher or lower operating temperature ranges consult Nook Industries, Inc.

7) Accessories such as boots, limit switches, top plates and clevises are available.

8) Catalog dimensions are representative only and are subject to change without notice. For construction, use only certified prints.

9) Units are not to be used as personnel support or movement.

10) End-of-travel stops are not provided.

11) Tare drag torque need only be added if operating under 25% rated load.

$$\text{Horsepower per jack} = \frac{\text{Torque to raise one pound} \times \text{Number of pounds to be raised} \times \text{rpm}}{63,025}$$

12) Starting Torque is 100% greater than torque shown.

13) Measurements listed are for non-keyed jacks. See individual jack pages for keyed jack info.

COLUMN STRENGTH MACHINE SCREW JACKS

Column strength is the ability of the lift shaft to hold compressive loads without buckling. With longer screw lengths, column strength may be substantially lower than nominal jack capacity.

If the lift shaft is in tension only, the screw jack travel is limited by the available screw material or by the critical speed of the screw. Refer to the acme screw technical section for critical speed limitations. If there is any possibility for the lift shaft to go into compression, the application should be sized for sufficient column strength.

The chart below is used to determine the required jack size in applications where the lift shaft is loaded in compression.

To use this chart:

Find a point at which the maximum length "L" intersects the maximum load. Be sure the jack selected is above and to the right of that point.

CAUTION: Chart does not include a design factor.

The chart assumes proper jack alignment with no bending loads on the screw. Effects from side loading are not included in this chart. Jacks operating horizontally with long lift shafts can experience bending from the weight of the screw.

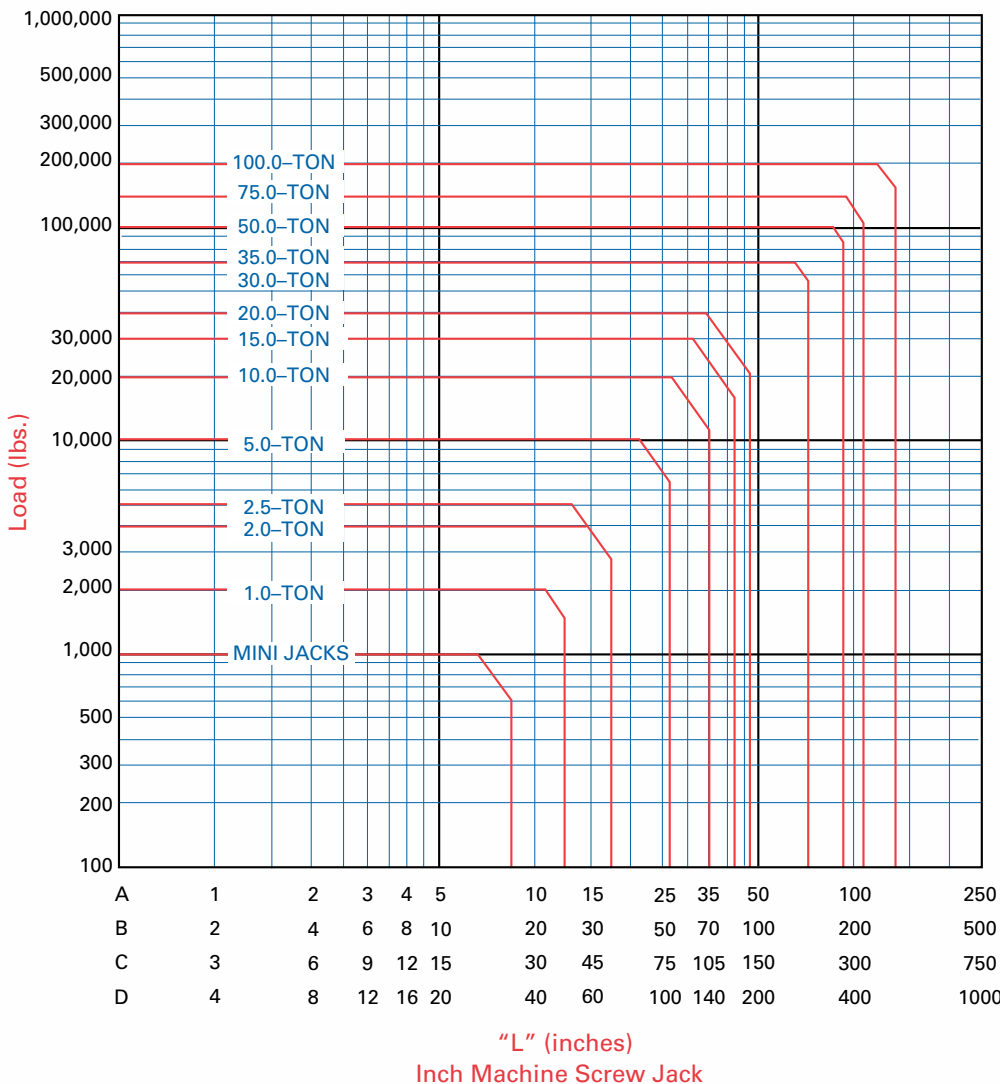

AVAILABLE LIFT SCREW LENGTHS

As a major manufacturer of industrial lead screws, Nook/Thomson stocks a wide selection of acme screws. Nook/Thomson has the capacity to make long acme screws for special applications. Rotating

MOUNTING CONDITIONS

A

ONE END FIXED
ONE END FREE

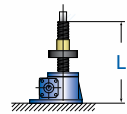

B

BOTH ENDS
SUPPORTED
BY CLEVIS
ENDS

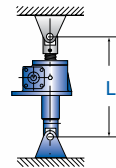

ONE END
BY CLEVIS END,
ONE BY
TRUNNION
MOUNT

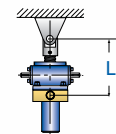

C

ONE END FIXED,
ONE END
SUPPORTED
(CLEVIS
ATTACHED TO
GUIDE STRUCTURE)

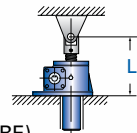

ONE END FIXED,
ONE END
SUPPORTED
(RADIAL BEARING)

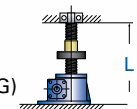

D

BOTH ENDS FIXED
(TOP PLATE
ATTACHED TO
GUIDED
STRUCTURE)

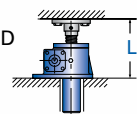

screw jacks can be built with a larger diameter lift screw for greater column strength, or a different lead to change the jack operating speed.

REFERENCE NUMBER SYSTEM

MACHINE SCREW JACKS

2.5-MSJ- U 6:1 / SSE-1 / 2CA-4C / FT / 24.5 / BS

MACHINE SCREW MODEL

Model #	Model #	Model #
MJ-20	2AB-MSJ	20-MSJ
MJ-25	2R-MSJ	20AB-MSJ
MJ-40	2RAB-MSJ	30-MSJ
MJ-50	2.5-MSJ	30AB-MSJ
MJ-80	2.5AB-MSJ	35-MSJ
MJ-100	5-MSJ	35AB-MSJ
MJ-160	5AB-MSJ	50-MSJ
MJ-200	10-MSJ	50AB-MSJ
1-MSJ	10AB-MSJ	75-MSJ
1AB-MSJ	15-MSJ	75AB-MSJ
2-MSJ	15AB-MSJ	100-MSJ

CONFIGURATION

U = Upright DC = Double Clevis
 I = Inverted UK = Upright Keyed
 UR = Upright Rotating IK = Inverted Keyed
 IR = Inverted Rotating

GEAR RATIO

Refer to product pages for available ratios.

SHAFT ORDER CODE

10BT - 1

CCW Position 1, 3, 5 & 7
 CW Position 2, 4, 6 & 8

ORDER CODES (Must Include A Position)

NOTE: Both Shaft Extensions Must Be Specified

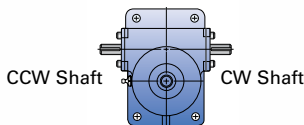

NO ACCESSORY

SSE- = Standard Shaft Extension, Position 1 or 2
 000- = Delete Shaft Extension, Position 1 or 2
 SPC- = Special Modified Shaft Extension, Position 1 or 2

Motor Mounts Without Motor (Position 1 or 2)

Used on 2.5 to 20 Ton Jacks. See pages 180-181.

Motor Mounts With Motors (Position 1 or 2)

Used on 2.5 to 20 Ton Jacks. See pages 180-181 & 184.

Right Angle Reducers (Position 1 through 8)

Used on 2.5 to 20 Ton Jacks. See pages 182-183.

Limit Switches (Position 1 C or E through 8 C or E)

Used on 2 to 100 Ton Jacks. See pages 192-197.

Hand Wheels

Used on MJ to 20 Ton Jacks. See page 185.

Counters

Used on MJ to 20 Ton Jacks. See page 199.

HOUSING CONFIGURATION

F = Standard Flange Base
 C = Clevis Base

SCREW CONFIGURATION

TRANSLATING - U and I MODELS

T = Standard Threaded End
 C = Clevis End
 P = Top Plate

ROTATING - UR and IR MODELS

A = Travel Nut Position "A"
 B = Travel Nut Position "B"

UR - Upright Rotating IR - Inverted Rotating

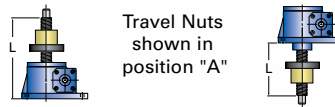

TRAVEL

For Translating Screw Models (U and I) use actual Travel in inches.
 For Rotating Screw Models (UR and IR) use "L" Dimension in Inches.

MODIFIER LIST

E and/or B Optional
 E = In-Line Encoder (Motor or motor mount required)
 B = Bellows Boots (See page 204-205. Must calculate extend and retract length.)
 P = Nook Tube Sensor System PNP
 N = Nook Tube Sensor System NPN

S or M Required

S = Standard, no additional description required
 M = Modified, additional description required



MINI JACKS

MJ-xx TOP VIEW

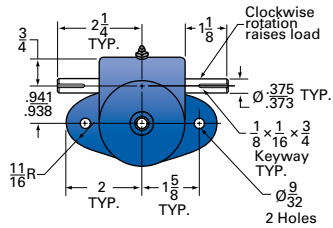

MJ-xx-U UPRIGHT

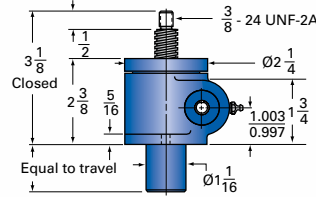

MJ-xx-I INVERTED

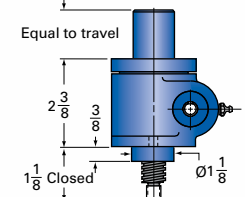

MODEL	Gear Ratio	Turns of Worm for 1" Travel	Torque at 1,000 lb. Load (in-lb)	Max Allowable Input (hp)	Screw Size†
MJ-20	5:1	20	19.3	1/3	1/2-4
MJ-25	5:1	25	20.7	1/3	5/8-5
MJ-40	5:1	40	16.7	1/3	5/8-8
MJ-50	5:1	50	13.5	1/3	1/2-10
MJ-80	20:1	80	8.0	1/6	1/2-4
MJ-100	20:1	100	8.7	1/6	5/8-5
MJ-160	20:1	160	7.0	1/6	5/8-8
MJ-200	20:1	200	5.7	1/6	1/2-10

† Lift shafts are made from 300 series stainless steel material except for 5/8-5.

Mini Jack Standard:
Start torque = 2 × Running Torque
Approximate weight (lbs)
"0" Travel: 2.5
Per inch travel: 0.2
Grease: 0.5

MJAB-xx-U UPRIGHT ANTI-BACKLASH

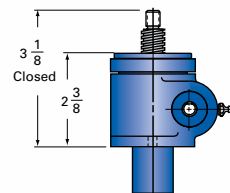

MJAB-xx-I INVERTED ANTI-BACKLASH

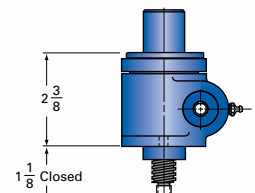

Lifting screw must be secured to prevent rotation for non-keyed units.
Caution: Jack may be self-lowering in some operating conditions.

MJ-xx-UR UPRIGHT ROTATING

For ordering, specify "L" dimension
 $L(\text{min}) = \text{travel} + 3\frac{21}{32}$

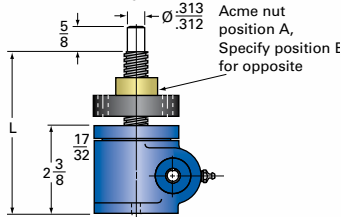

MJ-xx-IR INVERTED ROTATING

For ordering, specify "L" dimension
 $L(\text{min}) = \text{travel} + 1\frac{21}{32}$

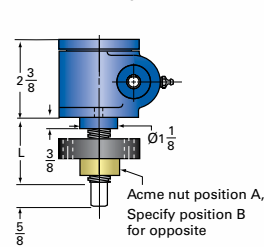

MJ-xx-UK UPRIGHT KEYED

MJ-xx-IK INVERTED KEYED

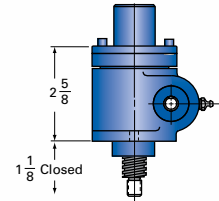
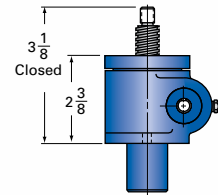

	RATING AT 1,750 RPM		COMPRESSION LOAD MAX TRAVEL **		NON-KEYED		KEYED	
	Load (lbs.)	Lift Rate (in/min)	At 1,000 lbs.	At any Load	Torque* (in-lb)	Max rpm at 1,000 Load	Torque* (in-lb)	Max rpm at Rated Load
	631	90.0	7.2	8.75	.019	1,090	.022	950
	571	72.0	8.3	9.38	.021	1,040	.024	900
	706	45.0	11.88	11.88	.017	1,260	.020	1,100
	857	36.0	8.3	9.38	.014	1,560	.016	1,350
	750	22.5	7.2	8.75	.008	1,310	.009	1,140
	667	18.0	8.3	9.38	.009	1,210	.010	1,050
	857	11.2	11.88	11.88	.007	1,500	.008	1,300
	1,000	9.0	8.3	9.38	.006	1,800	.007	1,560

* Torque to Raise 1 lb

** Travel is based on one end fixed and the other end free. See page 68 for other mounting considerations.

MINI JACK Acme Nut and Flange

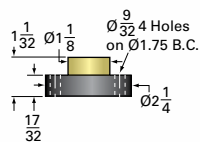

MINI JACK Options

Top Plate (optional): 9000-00-12

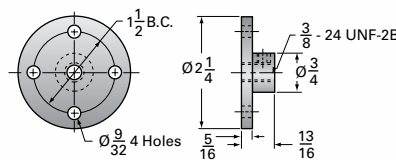

Clevis End (optional): 9001-00-12

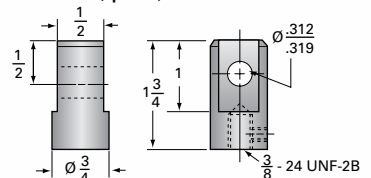

1-MSJ

1-MSJ TOP VIEW

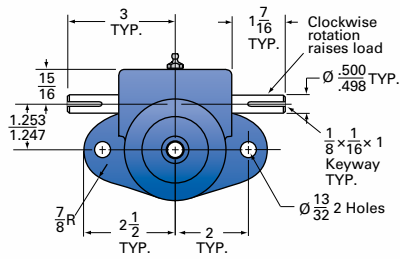

1-MSJ-U UPRIGHT

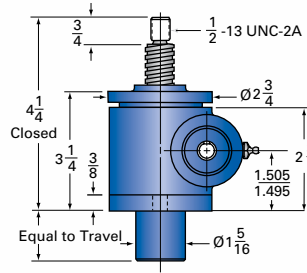

1-MSJ-I INVERTED

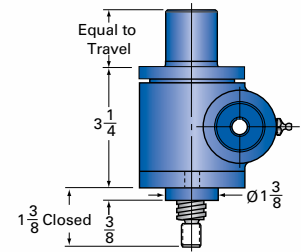

MODEL	Gear Ratio	Turns of Worm for 1" Travel	Max Input Torque (in-lb)	Max Allowable Input (hp)	Tare Drag Torque (in-lb)
1-MSJ	5:1	25	45	1/2	3
Capacity: 1 ton Screw: 3/4-5	20:1	100	21	1/4	3

Screw Specs:
 Root diameter (in): 0.502
 Screw lead (in): 0.200
 Start torque = 2 x Running Torque
 Approximate weight (lbs)
 "0" Travel: 5.5
 Per inch travel: 0.3
 Grease: 0.5

1AB-MSJ-U UPRIGHT ANTI-BACKLASH

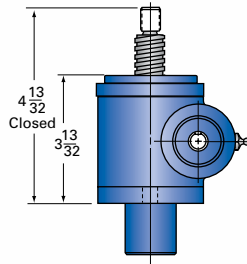

1AB-MSJ-I INVERTED ANTI-BACKLASH

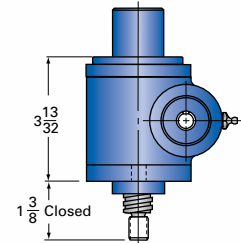

Lifting screw must be secured to prevent rotation for non-keyed units.
 Caution: Jack may be self-lowering in some operating conditions.

1-MSJ-UR UPRIGHT ROTATING

For ordering, specify "L" dimension
L(min) = travel + $5\frac{1}{32}$

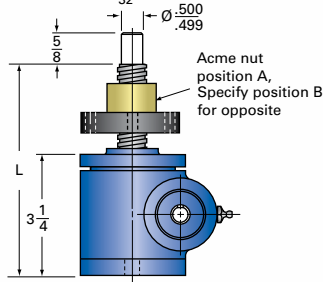

1-MSJ-IR INVERTED ROTATING

For ordering, specify "L" dimension
L(min) = travel + $2\frac{3}{32}$

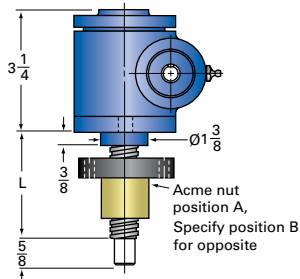

1-MSJ-UK UPRIGHT KEYED

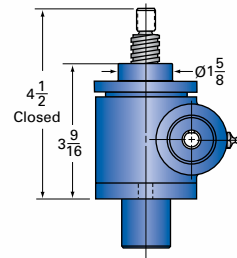

1-MSJ-IK INVERTED KEYED

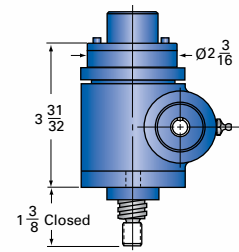

	NON-KEYED			KEYED		
	Torque to Raise 1 lb (in-lb)	Max Worm Speed at Rated Load (rpm)	Max Load at 1,750 rpm (lb)	Torque to Raise 1 lb (in-lb)	Max Worm Speed at Rated Load (rpm)	Max Load at 1,750 rpm (lb)
	.0225	700	800	.0259	608	695
	.0105	750	857	.0121	651	744

1-MSJ-DC DOUBLE CLEVIS

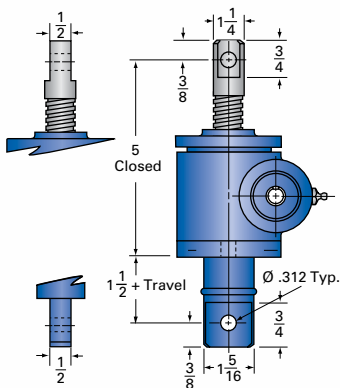

1-MSJ Acme Nut and Flange

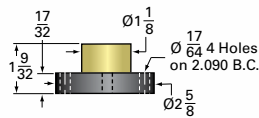

1-MSJ Options

Top Plate (optional): 9000-00-11

Clevis End (optional): 9001-00-11

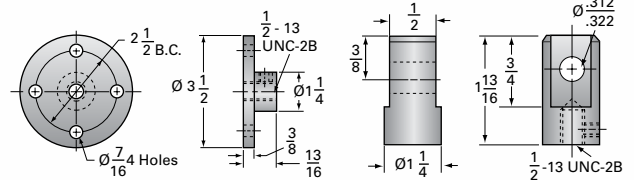

2-MSJ

2-MSJ TOP VIEW

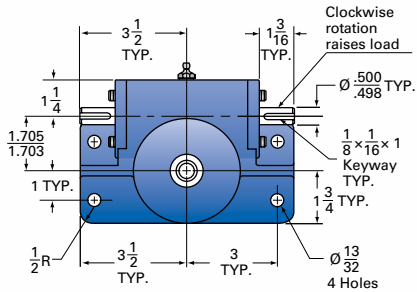

2-MSJ-U UPRIGHT

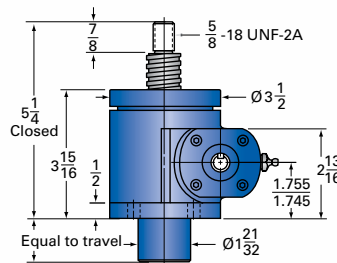

2-MSJ-I INVERTED

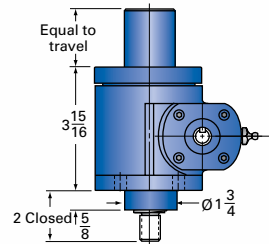

MODEL	Gear Ratio	Turns of Worm for 1" Travel	Max Input Torque (in-lb)	Max Allowable Input (hp)	Tare Drag Torque (in-lb)
2-MSJ	6:1	24	100	2	4
Capacity: 2 tons Screw: 1-4	12:1	48	62	1 1/2	4
	24:1	96	42	1/2	4

Screw Specs:
 Root diameter (in): 0.698
 Screw lead (in): 0.250
 Start torque = 2 x Running Torque
 Approximate weight (lbs)
 "0" Travel: 15
 Per inch travel: 0.45
 Grease: 0.5

2AB-MSJ-U UPRIGHT ANTI-BACKLASH

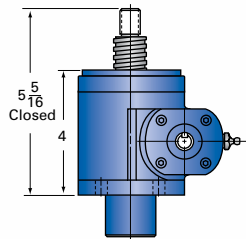

2AB-MSJ-I INVERTED ANTI-BACKLASH

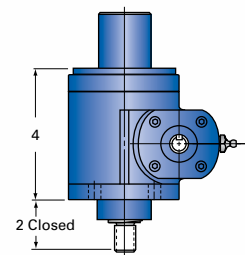

Lifting screw must be secured to prevent rotation for non-keyed units.
 Caution: Jack may be self-lowering in some operating conditions.

2-MSJ-UR UPRIGHT ROTATING

For ordering, specify "L" dimension
L(min) = travel + $6\frac{15}{16}$

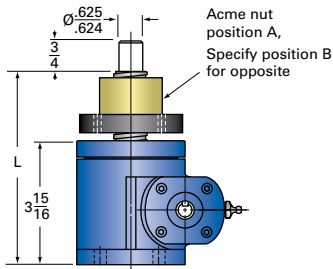

2-MSJ-IR INVERTED ROTATING

For ordering, specify "L" dimension
L(min) = travel + $3\frac{5}{8}$

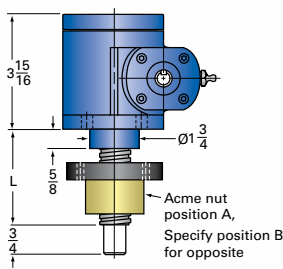

2-MSJ-UK UPRIGHT KEYED

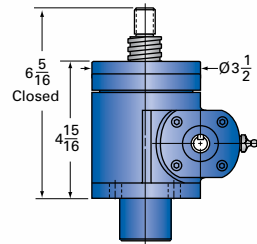

2-MSJ-IK INVERTED KEYED

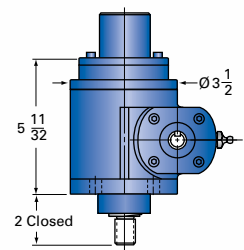

	NON-KEYED			KEYED		
	Torque to Raise 1 lb (in-lb)	Max Worm Speed at Rated Load (rpm)	Max Load at 1,750 rpm (lb)	Torque to Raise 1 lb (in-lb)	Max Worm Speed at Rated Load (rpm)	Max Load at 1,750 rpm (lb)
	.0250	1,260	2,881 lbs.	.0288	1,096	2,505
	.0154	1,525	3,486 lbs.	.0177	1,326	3,031
	.0105	750	1,715 lbs.	.0121	651	1,488

2-MSJ-DC DOUBLE CLEVIS

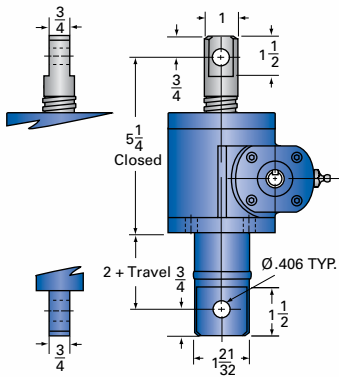

2-MSJ Acme Nut and Flange

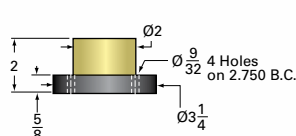

2-MSJ Options

Top Plate (optional): 9000-00-01

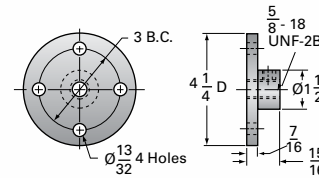

Clevis End (optional): 9001-00-01

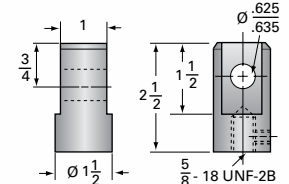

Motor Mount
see pg 180-181

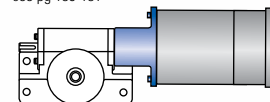

Limit Switch
see pg 196-201

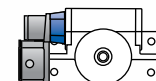

2R-MSJ

2R-MSJ TOP VIEW

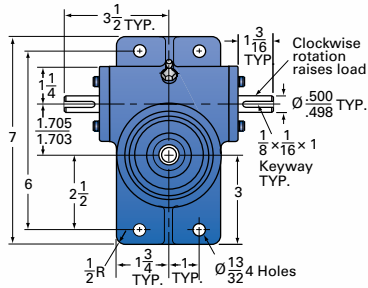

2R-MSJ-U UPRIGHT

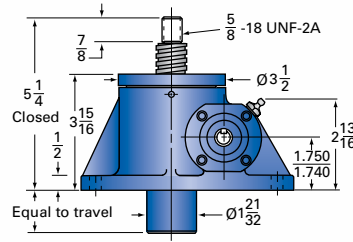

2R-MSJ-I INVERTED

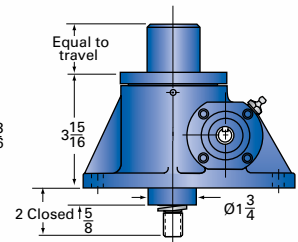

MODEL	Gear Ratio	Turns of Worm for 1" Travel	Max Input Torque (in-lb)	Max Allowable Input (hp)	Tare Drag Torque (in-lb)
2R-MSJ	6:1	24	100	2	4
Capacity: 2 tons Screw: 1-4	12:1	48	62	1 1/2	4
	24:1	96	42	1/2	4

Screw Specs:
 Root diameter (in): 0.698
 Screw lead (in): 0.250
 Start torque = 2 × Running Torque
 Approximate weight (lbs)
 "0" Travel: 15
 Per inch travel: 0.45
 Grease: 0.5

2RAB-MSJ-U UPRIGHT ANTI-BACKLASH

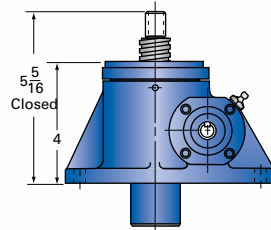

2RAB-MSJ-I INVERTED ANTI-BACKLASH

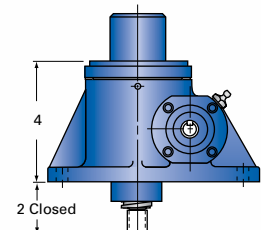

Lifting screw must be secured to prevent rotation for non-keyed units.
 Caution: Jack may be self-lowering in some operating conditions.

2R-MSJ-UR UPRIGHT ROTATING

For ordering, specify "L" dimension
L(min) = travel + $6\frac{15}{16}$

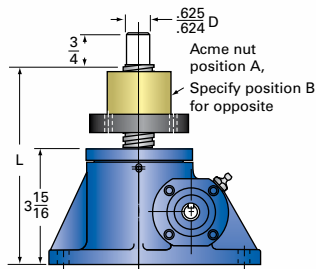

2R-MSJ-IR INVERTED ROTATING

For ordering, specify "L" dimension
L(min) = travel + $3\frac{9}{8}$

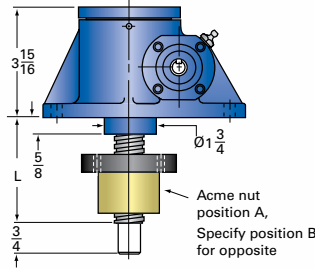

2R-MSJ-UK UPRIGHT KEYED

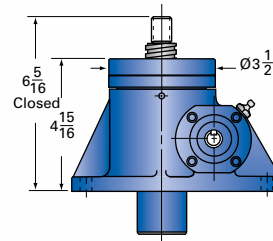

2R-MSJ-IK INVERTED KEYED

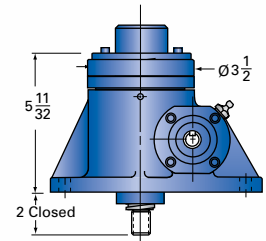

NON-KEYED			KEYED		
Torque to Raise 1 lb (in-lb)	Max Worm Speed at Rated Load (rpm)	Max Load at 1,750 rpm (lb)	Torque to Raise 1 lb (in-lb)	Max Worm Speed at Rated Load (rpm)	Max Load at 1,750 rpm (lb)
.0250	1,260	2,881	.0288 in-lb	1,096 rpm	2,505 lbs.
.0154	1,525	3,486	.0177 in-lb	1,326 rpm	3,031 lbs.
.0105	750	1,715	.0121 in-lb	651 rpm	1,488 lbs.

2R-MSJ-DC DOUBLE CLEVIS

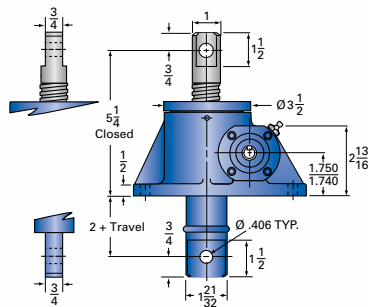

2R-MSJ Acme Nut and Flange

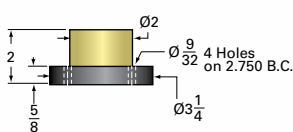

2R-MSJ Options

Top Plate (optional): 9000-00-01

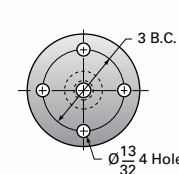

Clevis End (optional): 9001-00-01

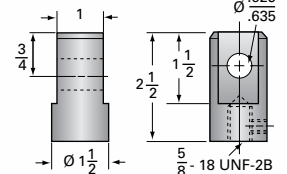

Motor Mount

see pg 180-181

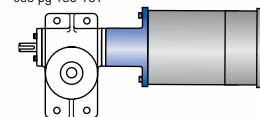

Limit Switch

see pg 196-201

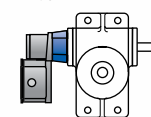

2.5-MSJ

2.5-MSJ TOP VIEW

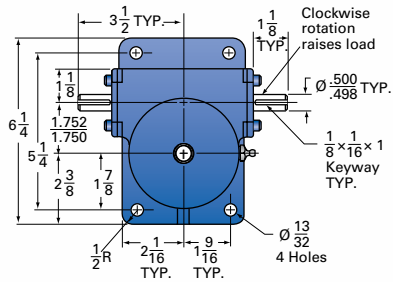

2.5-MSJ-U UPRIGHT

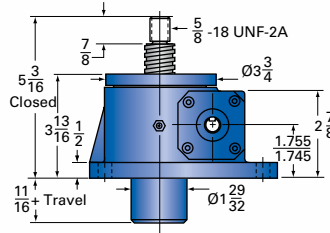

2.5-MSJ-I INVERTED

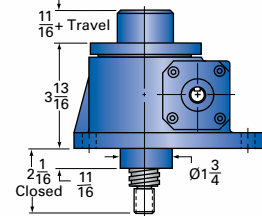

MODEL	Gear Ratio	Turns of Worm for 1" Travel	Max Input Torque (in-lb)	Max Allowable Input (hp)	Tare Drag Torque (in-lb)
2.5-MSJ	6:1	24	126	2	5
Capacity: 2.5 tons Screw: 1-4	12:1	48	74	1 1/2	5
	24:1	96	53	1/2	5

Screw Specs:
 Root diameter (in): 0.698
 Screw lead (in): 0.250
 Start torque = 2 × Running Torque
 Approximate weight (lbs)
 "0" Travel: 17
 Per inch travel: 0.45
 Grease: 0.5

2.5AB-MSJ-U UPRIGHT ANTI-BACKLASH

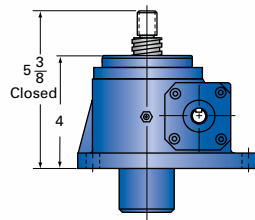

2.5AB-MSJ-I INVERTED ANTI-BACKLASH

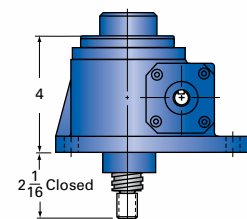

Lifting screw must be secured to prevent rotation for non-keyed units.
 Caution: Jack may be self-lowering in some operating conditions.

2.5-MSJ-UR UPRIGHT ROTATING

For ordering, specify "L" dimension
L(min) = travel + $6\frac{13}{16}$

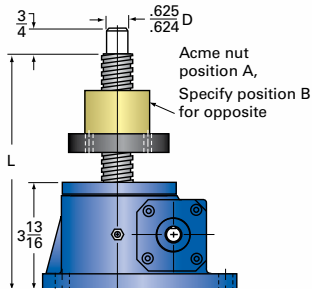

2.5-MSJ-IR INVERTED ROTATING

For ordering, specify "L" dimension
L(min) = travel + $3\frac{11}{16}$

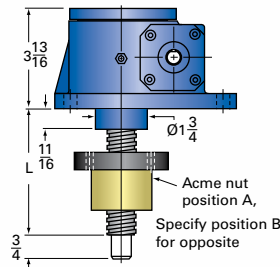

2.5-MSJ-UK UPRIGHT KEYED

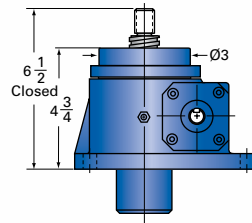

2.5-MSJ-IK INVERTED KEYED

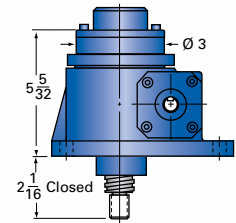

	NON-KEYED			KEYED		
	Torque to Raise 1 lb (in-lb)	Max Worm Speed at Rated Load (rpm)	Max Load at 1,750 rpm (lb)	Torque to Raise 1 lb (in-lb)	Max Worm Speed at Rated Load (rpm)	Max Load at 1,750 rpm (lb)
	.0252	1,000	2,858	.0290	869	2,483
	.0148	1,277	3,650	.0170	1,110	3,174
	.0106	594	1,699	.0122	516	1,476

2.5-MSJ-DC DOUBLE CLEVIS

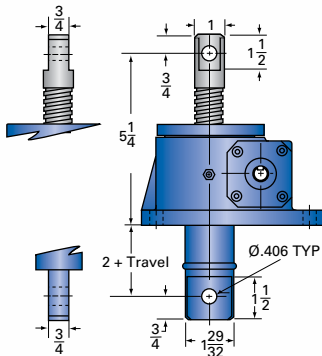

2.5-MSJ Acme Nut and Flange

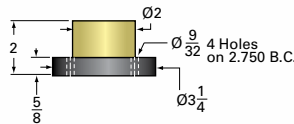

2.5-MSJ Options

Top Plate (optional): 9000-00-01

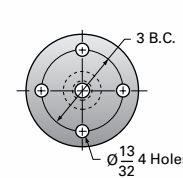

Clevis End (optional): 9001-00-01

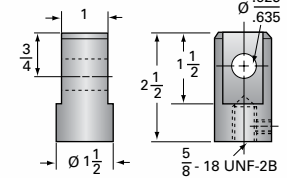

Motor Mount
see pg 180-181

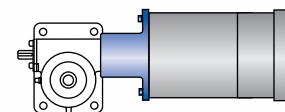

Limit Switch
see pg 196-201

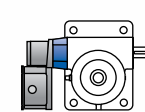

Secondary Reducer
see pg 182-187

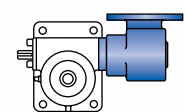

5-MSJ

5-MSJ TOP VIEW

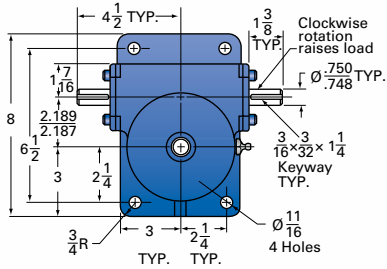

5-MSJ-U UPRIGHT

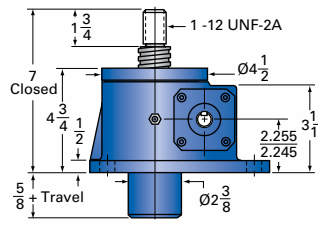

5-MSJ-I INVERTED

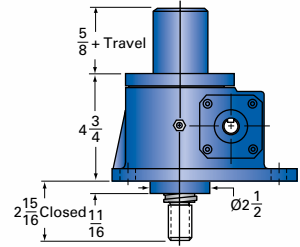

MODEL	Gear Ratio	Turns of Worm for 1" Travel	Max Input Torque (in-lb)	Max Allowable Input (hp)	Tare Drag Torque (in-lb)
5-MSJ	6:1	16	376	3	10
Capacity: 5 tons Screw: 1 1/2-2 3/8	24:1	64	144	3/4	10

Screw Specs:
 Root diameter (in): 1.066
 Screw lead (in): 0.375
 Start torque = 2 × Running Torque
 Approximate weight (lbs)
 "0" Travel: 30.0
 Per inch travel: 0.7
 Grease: 1.0

5AB-MSJ-U UPRIGHT ANTI-BACKLASH

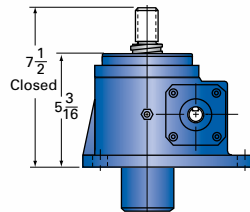

5AB-MSJ-I INVERTED ANTI-BACKLASH

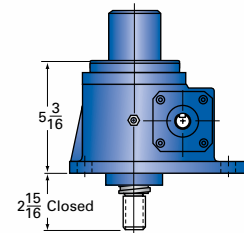

Lifting screw must be secured to prevent rotation for non-keyed units.
 Caution: Jack may be self-lowering in some operating conditions.

5-MSJ-UR UPRIGHT ROTATING

For ordering, specify "L" dimension
L(min) = travel + $8\frac{3}{4}$

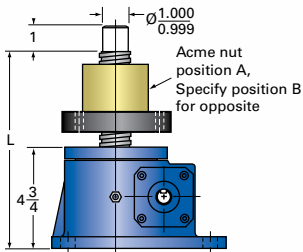

5-MSJ-IR INVERTED ROTATING

For ordering, specify "L" dimension
L(min) = travel + $4\frac{11}{16}$

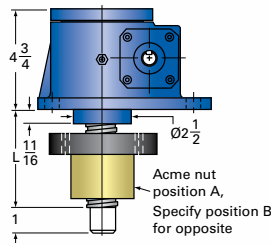

5-MSJ-UK UPRIGHT KEYED

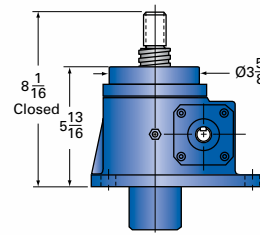

5-MSJ-IK INVERTED KEYED

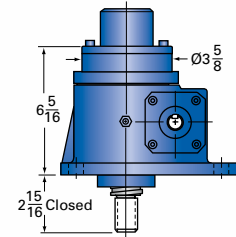

NON-KEYED			KEYED		
Torque to Raise 1 lb (in-lb)	Max Worm Speed at Rated Load (rpm)	Max Load at 1,750 rpm (lb)	Torque to Raise 1 lb (in-lb)	Max Worm Speed at Rated Load (rpm)	Max Load at 1,750 rpm (lb)
.0376	500	2,873	.0432	437	2,501
.0144	330	1,875	.0166	287	1,627

5-MSJ-DC DOUBLE CLEVIS

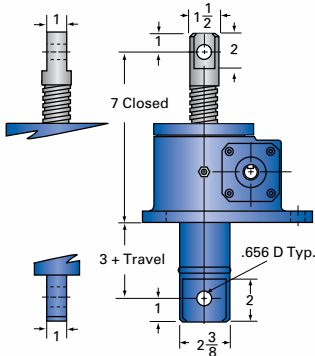

5-MSJ Acme Nut and Flange

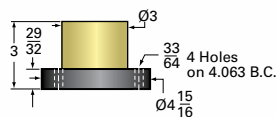

5-MSJ Options

Top Plate (optional): 9000-00-02

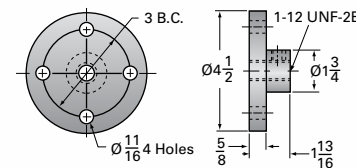

Clevis End (optional): 9001-00-02

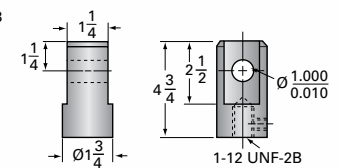

Motor Mount
see pg 180-181

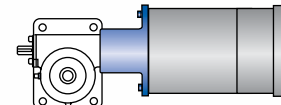

Limit Switch
see pg 196-201

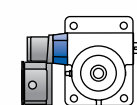

Secondary Reducer
see pg 182-187

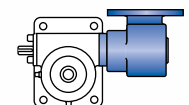

10-MSJ

10-MSJ TOP VIEW

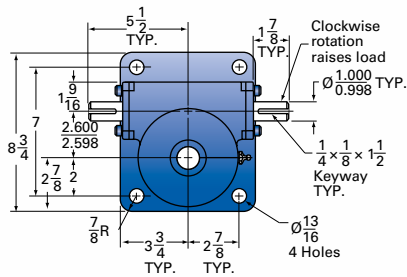

10-MSJ-U UPRIGHT

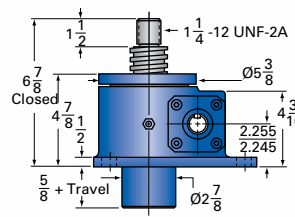

10-MSJ-I INVERTED

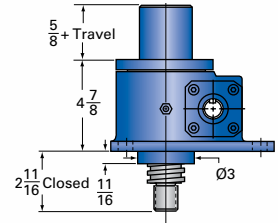

MODEL	Gear Ratio	Turns of Worm for 1" Travel	Max Input Torque (in-lb)	Max Allowable Input (hp)	Tare Drag Torque (in-lb)
10-MSJ	8:1	16	753	5	20
Capacity: 10 tons Screw: 2-2	24:1	48	384	1 1/2	20

Screw Specs:

- Root diameter (in): 1.410
- Screw lead (in): 0.5
- Start torque = 2 × Running Torque
- Approximate weight (lbs)
 - "0" Travel: 45.0
 - Per inch travel: 1.2
 - Grease: 1.5

10AB-MSJ-U UPRIGHT ANTI-BACKLASH

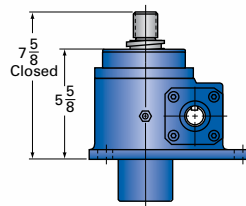

10AB-MSJ-I INVERTED ANTI-BACKLASH

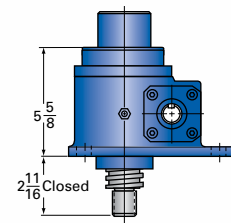

Lifting screw must be secured to prevent rotation for non-keyed units.
Caution: Jack may be self-lowering in some operating conditions.

10-MSJ-UR UPRIGHT ROTATING

For ordering, specify "L" dimension
L(min) = travel + $8\frac{7}{8}$

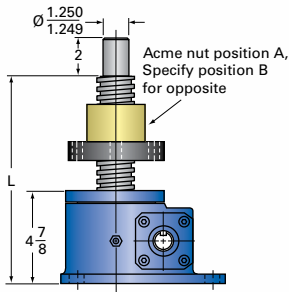

10-MSJ-IR INVERTED ROTATING

For ordering, specify "L" dimension
L(min) = travel + $4\frac{11}{16}$

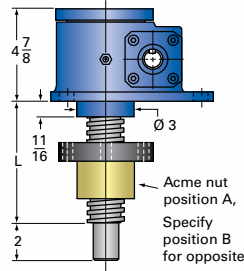

10-MSJ-UK UPRIGHT KEYED

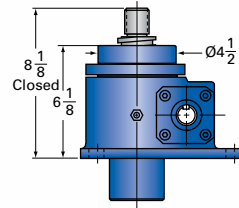

10-MSJ-IK INVERTED KEYED

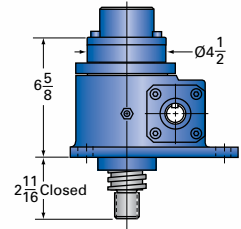

NON-KEYED			KEYED		
Torque to Raise 1 lb (in-lb)	Max Worm Speed at Rated Load (rpm)	Max Load at 1,750 rpm (lb)	Torque to Raise 1 lb (in-lb)	Max Worm Speed at Rated Load (rpm)	Max Load at 1,750 rpm (lb)
.0377	418	4,776	.0434	363	4,149
.0192	246	2,813	.0221	214	2,444

10-MSJ-DC DOUBLE CLEVIS

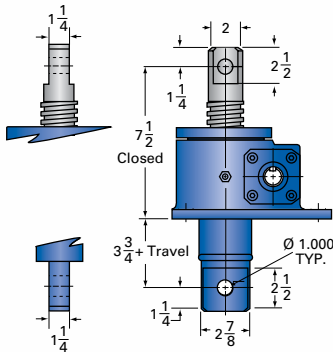

10-MSJ Acme Nut and Flange

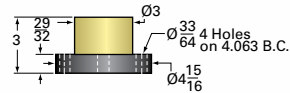

10-MSJ Options

Top Plate (optional): 9000-00-03

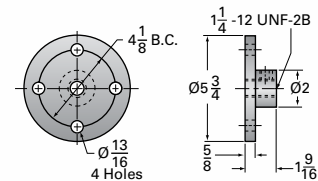

Clevis End (optional): 9001-00-03

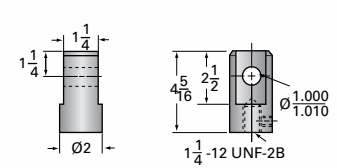

Motor Mount
see pg 180-181

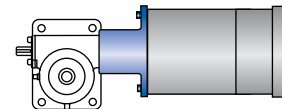

Limit Switch
see pg 196-201

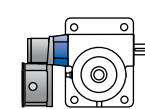

Secondary Reducer
see pg 182-187

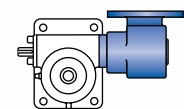

15-MSJ

15-MSJ TOP VIEW

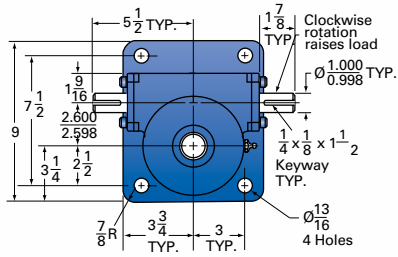

15-MSJ-U UPRIGHT

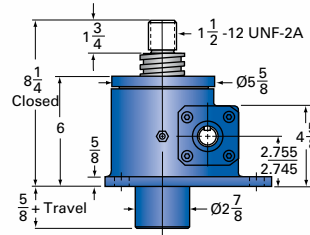

15-MSJ-I INVERTED

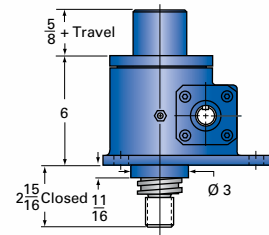

MODEL	Gear Ratio	Turns of Worm for 1" Travel	Max Input Torque (in-lb)	Max Allowable Input (hp)	Tare Drag Torque (in-lb)
15-MSJ	8:1	16	1,221	5	20
Capacity: 15 tons Screw: 2 1/4-2	24:1	48	654	1 1/2	20

Screw Specs:
 Root diameter (in): 1.684
 Screw lead (in): 0.5
 Start torque = 2 × Running Torque
 Approximate weight (lbs)
 "0" Travel: 55.0
 Per inch travel: 1.4
 Grease: 1.5

15AB-MSJ-U UPRIGHT ANTI-BACKLASH

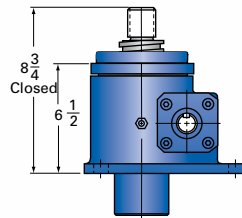

15AB-MSJ-I INVERTED ANTI-BACKLASH

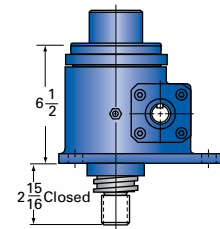

Lifting screw must be secured to prevent rotation for non-keyed units.
 Caution: Jack may be self-lowering in some operating conditions.

15-MSJ-UR UPRIGHT ROTATING

For ordering, specify "L" dimension
L(min) = travel + 10 1/2

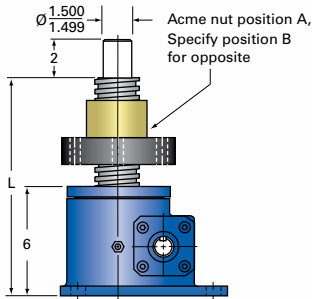

15-MSJ-IR INVERTED ROTATING

For ordering, specify "L" dimension
L(min) = travel + 5 3/16

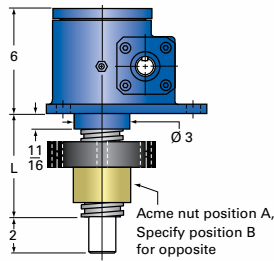

15-MSJ-UK UPRIGHT KEYED

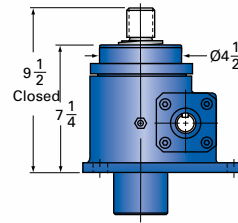

15-MSJ-IK INVERTED KEYED

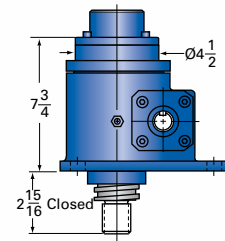

	NON-KEYED			KEYED		
	Torque to Raise 1 lb (in-lb)	Max Worm Speed at Rated Load (rpm)	Max Load at 1,750 rpm (lb)	Torque to Raise 1 lb (in-lb)	Max Worm Speed at Rated Load (rpm)	Max Load at 1,750 rpm (lb)
	.0407	258	4,424	.0468	224	3,847
	.0218	244	2,478	.0251	125	2,152

15-MSJ-DC DOUBLE CLEVIS

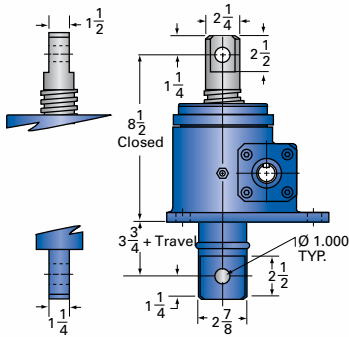

15-MSJ Acme Nut and Flange

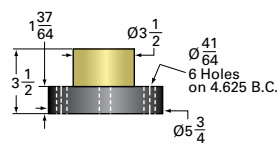

15-MSJ Options

Top Plate (optional): 9000-00-05

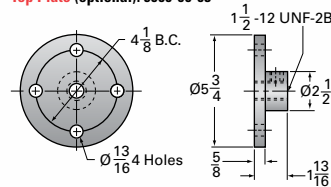

Clevis End (optional): 9001-00-05

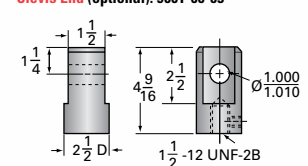

Motor Mount
see pg 180-181

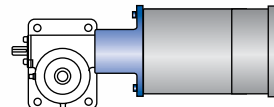

Limit Switch
see pg 196-201

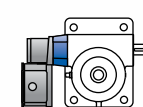

Secondary Reducer
see pg 182-187

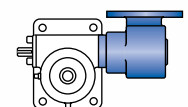

20-MSJ

20-MSJ TOP VIEW

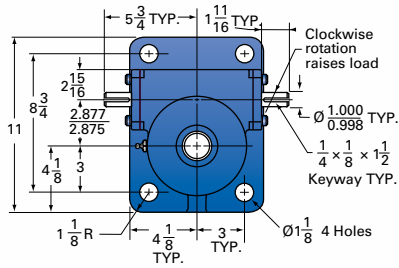

20-MSJ-U UPRIGHT

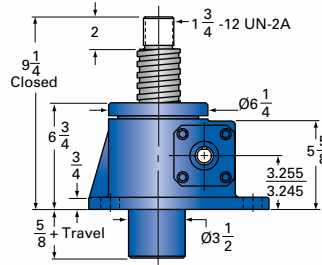

20-MSJ-I INVERTED

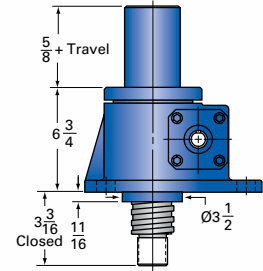

MODEL	Gear Ratio	Turns of Worm for 1" Travel	Max Input Torque (in-lb)	Max Allowable Input (hp)	Tare Drag Torque (in-lb)
20-MSJ	8:1	16	1,740	7 1/2	40
Capacity: 20 tons Screw: 2 1/2-2	24:1	48	873	2 1/2	40

Screw Specs:
 Root diameter (in): 1.908
 Screw lead (in): 0.500
 Start torque = 2 × Running Torque
 Approximate weight (lbs)
 "0" Travel: 80.0
 Per inch travel: 1.8
 Grease: 2.25

20AB-MSJ-U UPRIGHT ANTI-BACKLASH

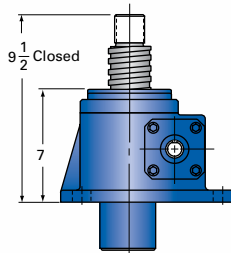

20AB-MSJ-I INVERTED ANTI-BACKLASH

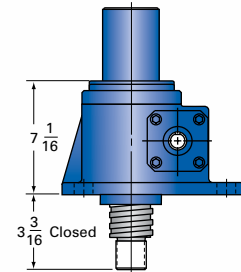

Lifting screw must be secured to prevent rotation for non-keyed units.
 Caution: Jack may be self-lowering in some operating conditions.

20-MSJ-UR UPRIGHT ROTATING

For ordering, specify "L" dimension
L(min) = travel + 11 1/4

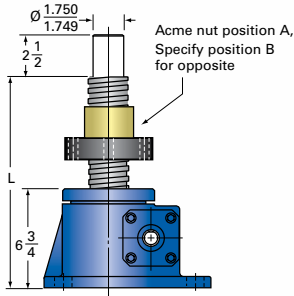

20-MSJ-IR INVERTED ROTATING

For ordering, specify "L" dimension
L(min) = travel + 5 3/16

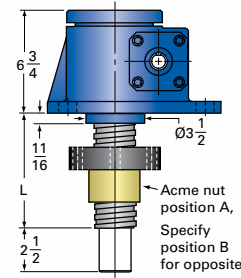

20-MSJ-UK UPRIGHT KEYED

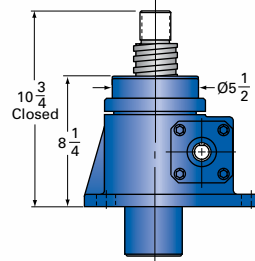

20-MSJ-IK INVERTED KEYED

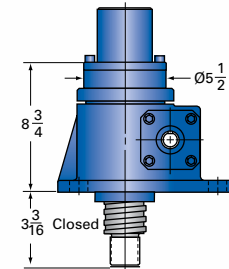

	NON-KEYED			KEYED		
	Torque to Raise 1 lb (in-lb)	Max Worm Speed at Rated Load (rpm)	Max Load at 1,750 rpm (lb)	Torque to Raise 1 lb (in-lb)	Max Worm Speed at Rated Load (rpm)	Max Load at 1,750 rpm (lb)
	.0435	272	6,209	.0500	236	5,402
	.0218	180	4,130	.0251	157	3,587

20-MSJ Acme Nut and Flange

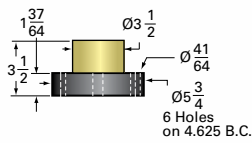

20-MSJ Options

Top Plate (optional): 9000-00-06

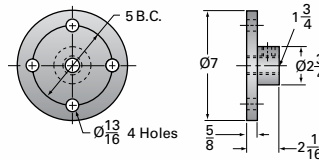

Clevis End (optional): 9001-00-06

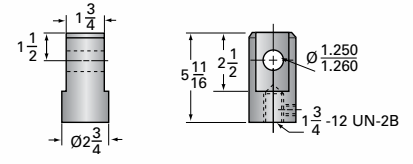

Motor Mount

see pg 180-181

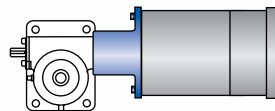

Limit Switch

see pg 196-201

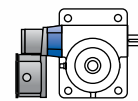

Secondary Reducer

see pg 182-187

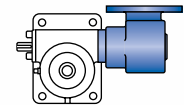

30-MSJ

30-MSJ TOP VIEW

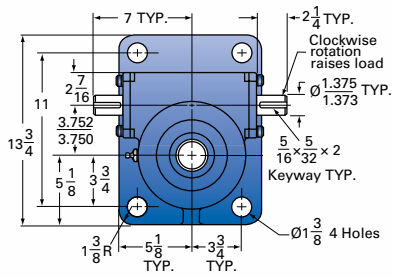

30-MSJ-U UPRIGHT

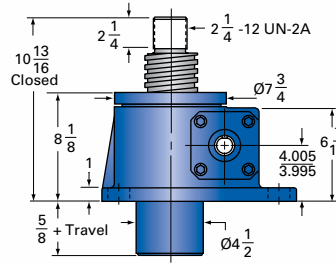

30-MSJ-I INVERTED

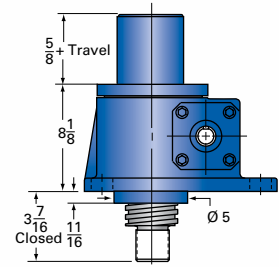

MODEL	Gear Ratio	Turns of Worm for 1" Travel	Max Input Torque (in-lb)	Max Allowable Input (hp)	Tare Drag Torque (in-lb)
30-MSJ	10 ² / ₃ :1	16	2,710	11	50
Capacity: 30 tons Screw: 3 ³ / ₈ -1 ¹ / ₂	32:1	48	1,411	3 ¹ / ₂	50

Screw Specs:
 Root diameter (in): 2.652
 Screw lead (in): 0.667
 Start torque = 2 × Running Torque
 Approximate weight (lbs)
 "0" Travel: 145.0
 Per inch travel: 2.9
 Grease: 3.5

30AB-MSJ-U UPRIGHT ANTI-BACKLASH

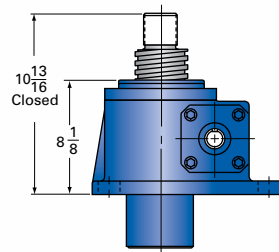

30AB-MSJ-I INVERTED ANTI-BACKLASH

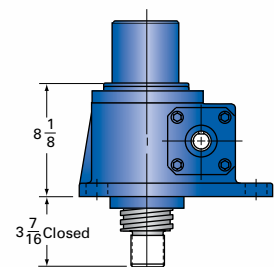

Lifting screw must be secured to prevent rotation for non-keyed units.
 Caution: Jack may be self-lowering in some operating conditions.

30-MSJ-UR UPRIGHT ROTATING

For ordering, specify "L" dimension
L(min) = travel + $13\frac{3}{16}$

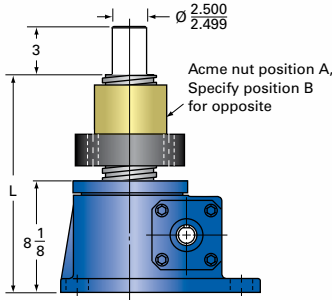

30-MSJ-IR INVERTED ROTATING

For ordering, specify "L" dimension
L(min) = travel + $6\frac{3}{16}$

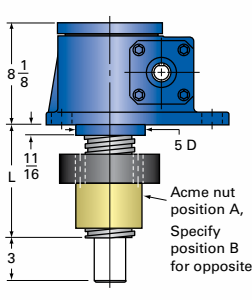

30-MSJ-UK UPRIGHT KEYED*

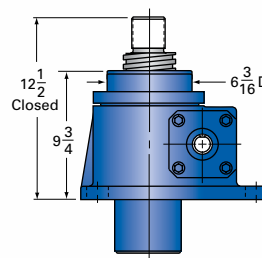

30-MSJ-IK INVERTED KEYED*

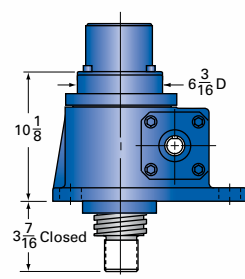

*For a 30 ton keyed jack, derate max capacity by 40%

	NON-KEYED			KEYED		
	Torque to Raise 1 lb (in-lb)	Max Worm Speed at Rated Load (rpm)	Max Load at 1,750 rpm (lb)	Torque to Raise 1 lb (in-lb)	Max Worm Speed at Rated Load (rpm)	Max Load at 1,750 rpm (lb)
	.0452	256	8,764	.0520	222	7,618
	.0235	156	5,364	.0270	136	4,668

30-MSJ Acme Nut and Flange

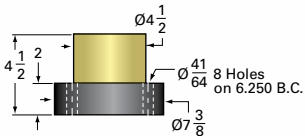

30-MSJ Options

Top Plate (optional): 9000-00-07

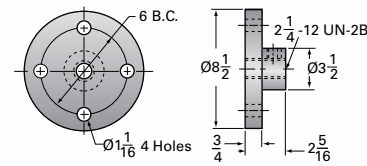

Clevis End (optional): 9001-00-08

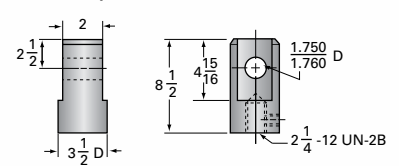

Motor Mount
see pg 180-181

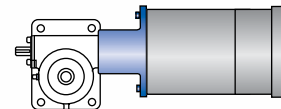

Limit Switch
see pg 196-201

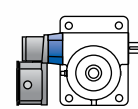

35-MSJ

35-MSJ TOP VIEW

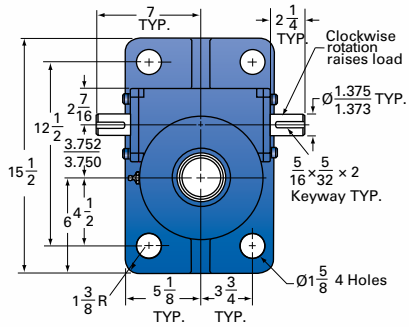

35-MSJ-U UPRIGHT

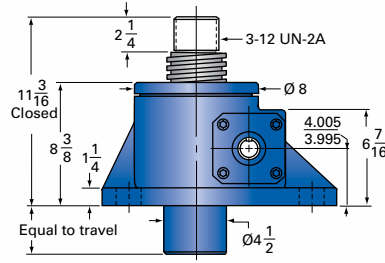

35-MSJ-I INVERTED

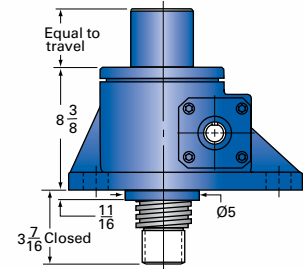

MODEL	Gear Ratio	Turns of Worm for 1" Travel	Max Input Torque (in-lb)	Max Allowable Input (hp)	Tare Drag Torque (in-lb)
35-MSJ	10 ² / ₃ :1	16	3,450	11	50
Capacity: 35 tons Screw: 3 ³ / ₄ -1 ¹ / ₂	32:1	48	1,800	3 ¹ / ₂	50

Screw Specs:
 Root diameter (in): 3.009
 Screw lead (in): 0.667
 Start torque = 2 × Running Torque
 Approximate weight (lbs)
 "0" Travel: 145.0
 Per inch travel: 3.4
 Grease: 3.5

35AB-MSJ-U UPRIGHT ANTI-BACKLASH

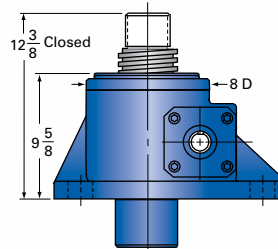

35AB-MSJ-I INVERTED ANTI-BACKLASH

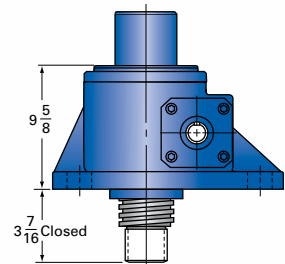

Lifting screw must be secured to prevent rotation for non-keyed units.
 Caution: Jack may be self-lowering in some operating conditions.

35-MSJ-UR UPRIGHT ROTATING

For ordering, specify "L" dimension
L(min) = travel + 18 $\frac{3}{8}$

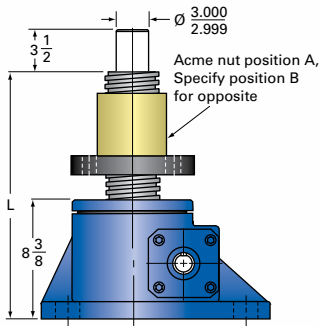

35-MSJ-IR INVERTED ROTATING

For ordering, specify "L" dimension
L(min) = travel + 10 $\frac{11}{16}$

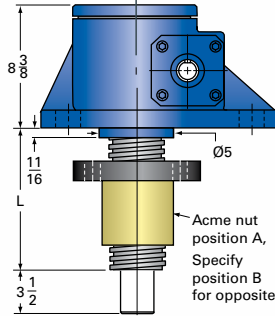

35-MSJ-UK UPRIGHT KEYED*

35-MSJ-IK INVERTED KEYED*

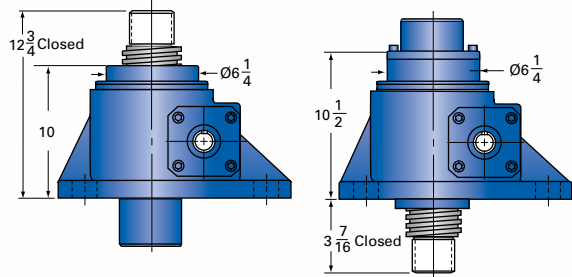

*For a 35 ton keyed jack, derate max capacity by 40%

NON-KEYED			KEYED		
Torque to Raise 1 lb (in-lb)	Max Worm Speed at Rated Load (rpm)	Max Load at 1,750 rpm (lb)	Torque to Raise 1 lb (in-lb)	Max Worm Speed at Rated Load (rpm)	Max Load at 1,750 rpm (lb)
.0493	200	8,035	.0570	174	6,950
.0257	122	4,904	.0295	107	4,273

35-MSJ Acme Nut and Flange

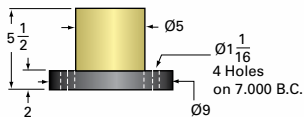

35-MSJ Options

Top Plate (optional): 9000-00-013

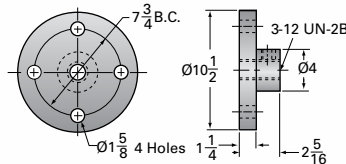

Clevis End (optional): 9001-00-16

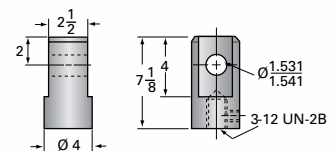

Limit Switch

see pg 196-201

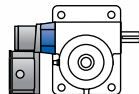

50-MSJ

50-MSJ TOP VIEW

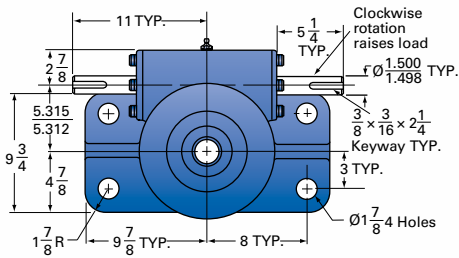

50-MSJ-U UPRIGHT

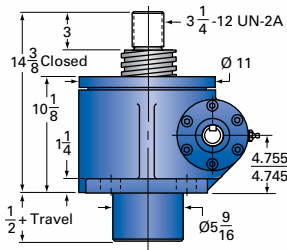

50-MSJ-I INVERTED

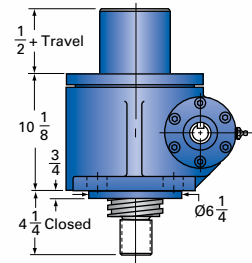

MODEL	Gear Ratio	Turns of Worm for 1" Travel	Max Input Torque (in-lb)	Max Allowable Input (hp)	Tare Drag Torque (in-lb)
50-MSJ	10 2/3:1	16	5,555	16	100
Capacity: 50 tons Screw: 4 1/2-1 1/2	32:1	48	3,014	5	100

Screw Specs:
 Root diameter (in): 3.782
 Screw lead (in): 0.667
 Start torque = 2 x Running Torque
 Approximate weight (lbs)
 "0" Travel: 280.0
 Per inch travel: 5.0
 Grease: 5.8

50AB-MSJ-U UPRIGHT ANTI-BACKLASH

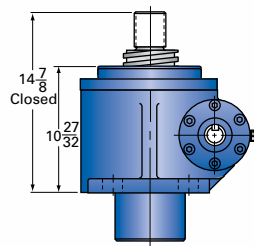

50AB-MSJ-I INVERTED ANTI-BACKLASH

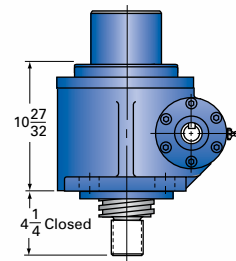

Lifting screw must be secured to prevent rotation for non-keyed units.
 Caution: Jack may be self-lowering in some operating conditions.

50-MSJ-UR UPRIGHT ROTATING

For ordering, specify "L" dimension
L(min) = travel + $17\frac{7}{8}$

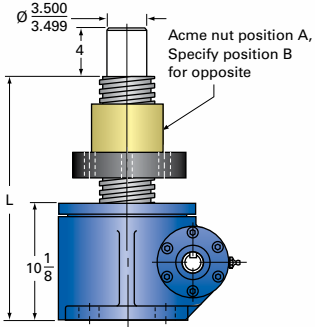

50-MSJ-IR INVERTED ROTATING

For ordering, specify "L" dimension
L(min) = travel + $7\frac{3}{4}$

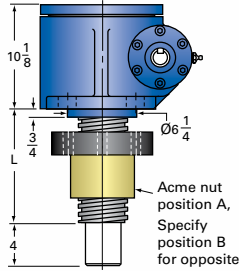

50-MSJ-UK UPRIGHT KEYED*

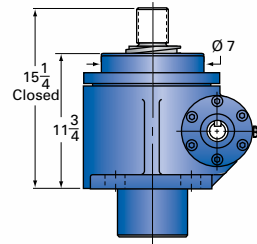

50-MSJ-IK INVERTED KEYED*

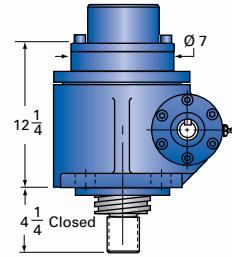

*For a 50 ton keyed jack, derate max capacity by 35%

	NON-KEYED			KEYED		
	Torque to Raise 1 lb (in-lb)	Max Worm Speed at Rated Load (rpm)	Max Load at 1,750 rpm (lb)	Torque to Raise 1 lb (in-lb)	Max Worm Speed at Rated Load (rpm)	Max Load at 1,750 rpm (lb)
	.0555	181	10,382	.0638	158	9,032
	.0301	104	5,982	.0346	91	5,204

50-MSJ Acme Nut and Flange

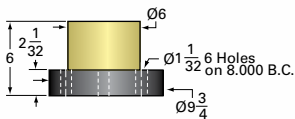

50-MSJ Options

Top Plate (optional): 9000-00-09

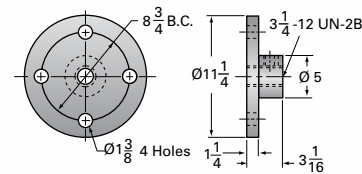

Clevis End (optional): 9001-00-09

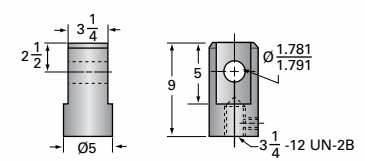

Limit Switch
see pg 196-201

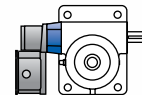

75-MSJ

75-MSJ TOP VIEW

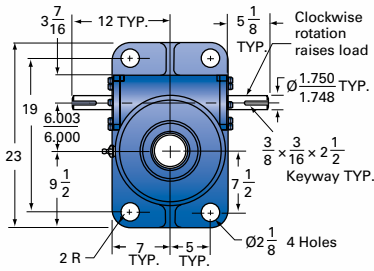

75-MSJ-U UPRIGHT

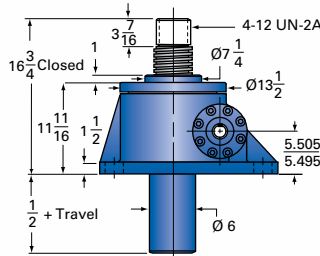

75-MSJ-I INVERTED

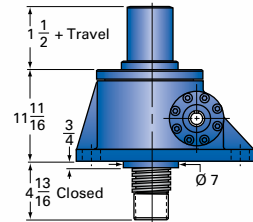

MODEL	Gear Ratio	Turns of Worm for 1" Travel	Max Input Torque (in-lb)	Max Allowable Input (hp)	Tare Drag Torque (in-lb)
75-MSJ	10 ² / ₃ :1	16	8,236	28	155
Capacity: 75 tons Screw: 5-1 1/2	32:1	48	3,780	9	155

Screw Specs:
 Root diameter (in): 4.286
 Screw lead (in): 0.667
 Start torque = 2 × Running Torque
 Approximate weight (lbs)
 "0" Travel: 610.0
 Per inch travel: 6.5
 Grease: 9.0

Lifting screw must be secured to prevent rotation for non-keyed units.
 Caution: Jack may be self-lowering in some operating conditions.

75-MSJ-UR UPRIGHT ROTATING

For ordering, specify "L" dimension
 $L(\text{min}) = \text{travel} + 22\frac{3}{16}$

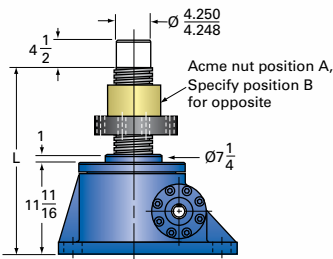

75-MSJ-IR INVERTED ROTATING

For ordering, specify "L" dimension
 $L(\text{min}) = \text{travel} + 10\frac{1}{4}$

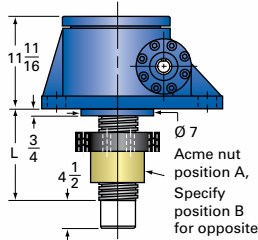

75-MSJ-UK UPRIGHT KEYED*

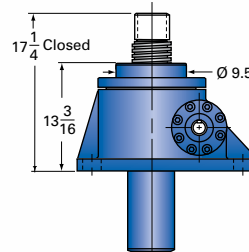

75-MSJ-IK INVERTED KEYED*

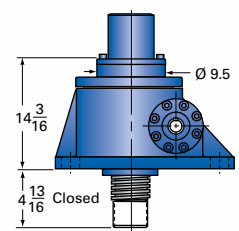

*For a 75 ton keyed jack, derate max capacity by 35%

NON-KEYED			KEYED		
Torque to Raise 1 lb (in-lb)	Max Worm Speed at Rated Load (rpm)	Max Load at 1,750 rpm (lb)	Torque to Raise 1 lb (in-lb)	Max Worm Speed at Rated Load (rpm)	Max Load at 1,750 rpm (lb)
.0549	214	18,368	.0631	186	15,950
.0252	150	12,862	.0290	130	11,180

75-MSJ Acme Nut and Flange

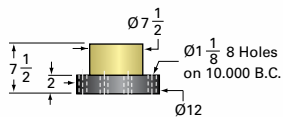

75-MSJ Options

Top Plate (optional): 9000-00-20

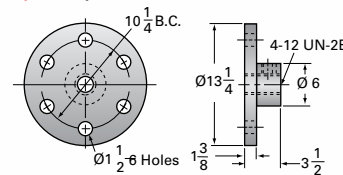

Clevis End (optional): 9001-00-20

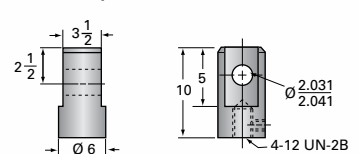

Limit Switch
see pg 196-201

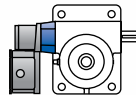

100-MSJ

100-MSJ TOP VIEW

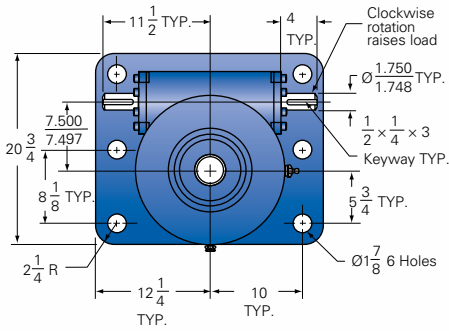

100-MSJ-U UPRIGHT

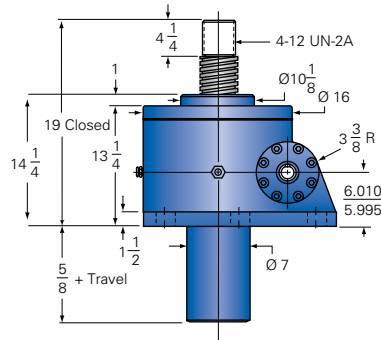

100-MSJ-I INVERTED

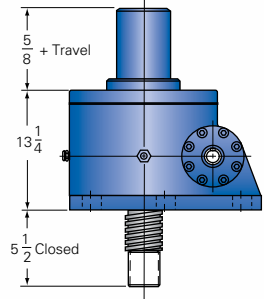

MODEL	Gear Ratio	Turns of Worm for 1" Travel	Max Input Torque (in-lb)	Max Allowable Input (hp)	Tare Drag Torque (in-lb)
100-MSJ	10 2/3:1	16	13,166	32	205
Capacity: 100 tons Screw: 6-1 1/2	32:1	48	7,460	12 1/2	205

Screw Specs:
 Root diameter (in): 5.254
 Screw lead (in): 0.667
 Start torque = 2 × Running Torque
 Approximate weight (lbs)
 "0" Travel: 975.0
 Per inch travel: 8.5
 Grease: 16.0

Lifting screw must be secured to prevent rotation for non-keyed units.
 Caution: Jack may be self-lowering in some operating conditions.

100-MSJ-UR UPRIGHT ROTATING

For ordering, specify "L" dimension
L(min) = travel + $23\frac{25}{32}$

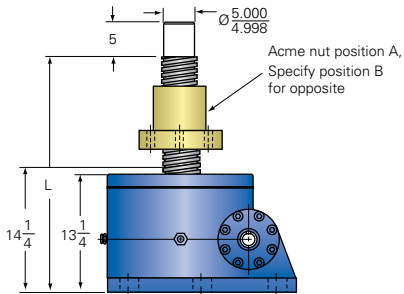

100-MSJ-IR INVERTED ROTATING

For ordering, specify "L" dimension
L(min) = travel + $10\frac{1}{4}$

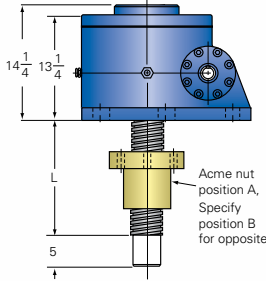

NON-KEYED			KEYED		
Torque to Raise 1 lb (in-lb)	Max Worm Speed at Rated Load (rpm)	Max Load at 1,750 rpm (lb)	Torque to Raise 1 lb (in-lb)	Max Worm Speed at Rated Load (rpm)	Max Load at 1,750 rpm (lb)
.0665	153	17,330	-	-	-
.0377	106	11,941	-	-	-

100-MSJ Acme Nut and Flange

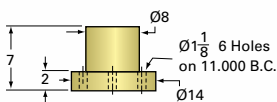

100-MSJ Options

Top Plate (optional): 9000-00-21

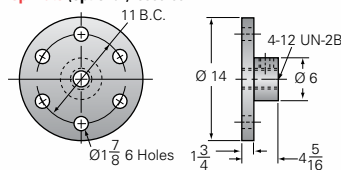

Clevis End (optional): 9001-00-21

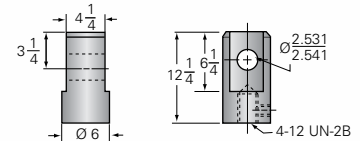

Limit Switch
see pg 196-201

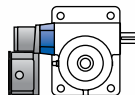

STAINLESS STEEL MACHINE SCREW JACKS

ActionJac™ Stainless Steel Machine Screw Jacks are ideal for use in demanding environments where corrosion resistance is required. All external components are manufactured from 300 series Stainless Steel materials. These jacks use a stainless steel worm with a high strength bronze drive sleeve. The worm and drive sleeve are supported by tapered roller bearings and sealed to prevent loss of lubrication and to resist contamination. The stainless steel lifting screw threads are precision formed to Class 2-C (centralizing) thread profiles.

Load capacities for Stainless Steel Machine Screw Jacks range from 1,300 to 23,000 pounds. A 17-4PH hardened worm is available for a 300% increase in capacity.

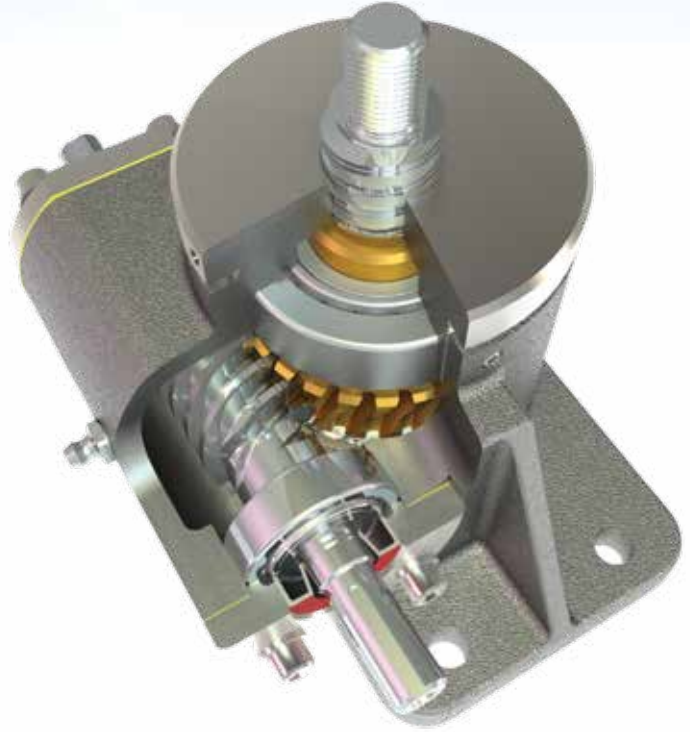

Nook/Thomson stainless steel machine screw jacks are used extensively in the paper industry.

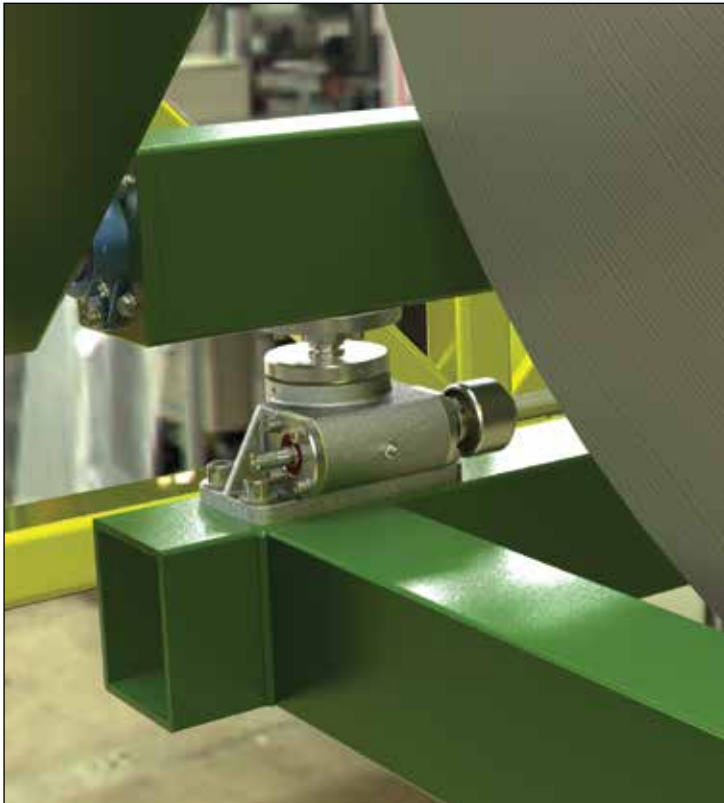

STAINLESS STEEL MACHINE SCREW

JACKS 98-103

..... Quick Reference
100-101
..... Column Strength
102
..... Reference Number System
103

TECHNICAL DATA 104-117

..... 2SS-MSJ
104-105
..... 5SS-MSJ
106-107
..... 10SS-MSJ
108-109
..... 15SS-MSJ
110-111
..... 20SS-MSJ
112-113
..... 25SS-MSJ
114-115
..... 35SS-MSJ
116-117

QUICK REFERENCE

STAINLESS STEEL JACKS

MODEL	Gear Ratio	Capacity (tons)	Lifting Screw Dia (in)	Screw Lead (in)	Root Dia (in)	Turns of Worm for 1" Travel	Max Input Torque (in.-lb.)	Max Input (hp)	Max Worm Speed at Rated Load (rpm)	Max Load at 1,750 rpm (lb)	Torque to Raise 1 lb. (in-lb)	Tare Drag Torque (in-lb)
2SS-MSJ	6:1	0.66	1	.250	.698	24	33	2	1,800	1,320	.0250	4
	24:1	0.66	1	.250	.698	96	14	½	1,800	1,320	.0150	4
5SS-MSJ	6:1	1.67	1½	.375	1.066	16	125	3	1,510	2,873	.0376	10
	24:1	1.67	1½	.375	1.066	64	48	¾	985	1,875	.0144	10
10SS-MSJ	8:1	3.33	2	.500	1.410	16	251	5	1,255	4,775	.0377	20
	24:1	3.33	2	.500	1.410	48	128	1½	739	2,813	.0192	20
15SS-MSJ	8:1	5.00	2¼	.500	1.684	16	407	5	774	4,424	.0407	20
	24:1	5.00	2¼	.500	1.684	48	218	1½	434	2,478	.0218	20
20SS-MSJ	8:1	6.66	2½	.500	1.908	16	580	5	540	4,140	.0435	40
	24:1	6.66	2½	.500	1.908	48	291	1½	325	2,478	.0218	40
25SS-MSJ	10½:1	8.30	3	.667	2.287	16	903	11	768	8,764	.0452	50
	32:1	8.30	3	.667	2.287	48	471	3½	468	5,364	.0235	50
35SS-MSJ	10½:1	11.66	3¾	.667	3.0	16	1,150	11	603	8,035	.0493	50
	32:1	11.66	3¾	.667	3.0	48	600	3½	368	5,022	.0251	50

If the worm is changed to 17-4PH, refer to page 66 for jack capacity.



Nook/Thomson stainless steel jacks are used widely in the commercial food industry.

NOTES:

- 1) The recommended maximum speed is 1,800 rpm provided that the recommended horsepower and temperature are not exceeded.
- 2) Input torque is shown as torque to lift one pound of load. Starting Torque is 100% greater than torque shown. Tare drag torque should be added for all loads.
- 3) Maximum allowable horsepower ratings are based on a 25% duty cycle at standard ambient temperature, with 1 minute on 2 minute off cycles. For operation at higher duty cycles or repeated use over any segment of the total travel, temperature must be monitored and remain less than 200°F.
- 4) Overload capacity of the Stainless Steel Machine Screw Jack is as follows: 10% for dynamic loads, 30% for static loads.
- 5) Stainless Steel Machine Screw Jacks having gear ratios between 20:1 and 32:1, are self-locking and will hold loads without backdriving in the absence of vibration. All other ratios may require a brake to prevent backdriving.
- 6) All units are suitable for intermittent operation providing that the housing temperature including ambient is not lower than -20°F. or higher than +200°F. Factory supplied grease in standard units will operate in this range. For higher or lower operating temperature ranges consult Nook/Thomson.

- 7) Accessories such as boots, top plates and clevises are available.
- 8) Catalog dimensions are representative only and are subject to change without notice. For construction, use only certified prints.
- 9) Units are not to be used as personnel support or movement.
- 10) End-of-travel stops are not provided.
- 11) For greater capacity, specify a 17-4PH hardened worm.
- 12) Tare drag torque need only be added if operating under 25% rated load.

$$\text{Horsepower per jack} = \frac{\text{Torque to raise one pound} \times \text{Number of pounds to be raised} \times \text{rpm}}{63,025}$$

- 13) Starting Torque is 100% greater than torque shown.



Nook/Thomson stainless steel jacks used in a dairy processing application.

COLUMN STRENGTH STAINLESS STEEL JACKS

Column strength is the ability of the lift shaft to hold compressive loads without buckling. With longer screw lengths, column strength may be substantially lower than nominal jack capacity.

If the lift shaft is in tension only, the screw jack travel is limited by the available screw material or by the critical speed of the screw. Refer to the acme screw technical section for critical speed limitations. If there is any possibility for the lift shaft to go into compression, the application should be sized for sufficient column strength.

The chart below is used to determine the required jack size in applications where the lift shaft is loaded in compression.

To use this chart:

Find a point at which the maximum length "L" intersects the maximum load. Be sure the jack selected is above and to the right of that point.

CAUTION: Chart does not include a design factor.

The chart assumes proper jack alignment with no bending loads on the screw. Effects from side loading are not included in this chart. Jacks operating horizontally with long lift shafts can experience bending from the weight of the screw.

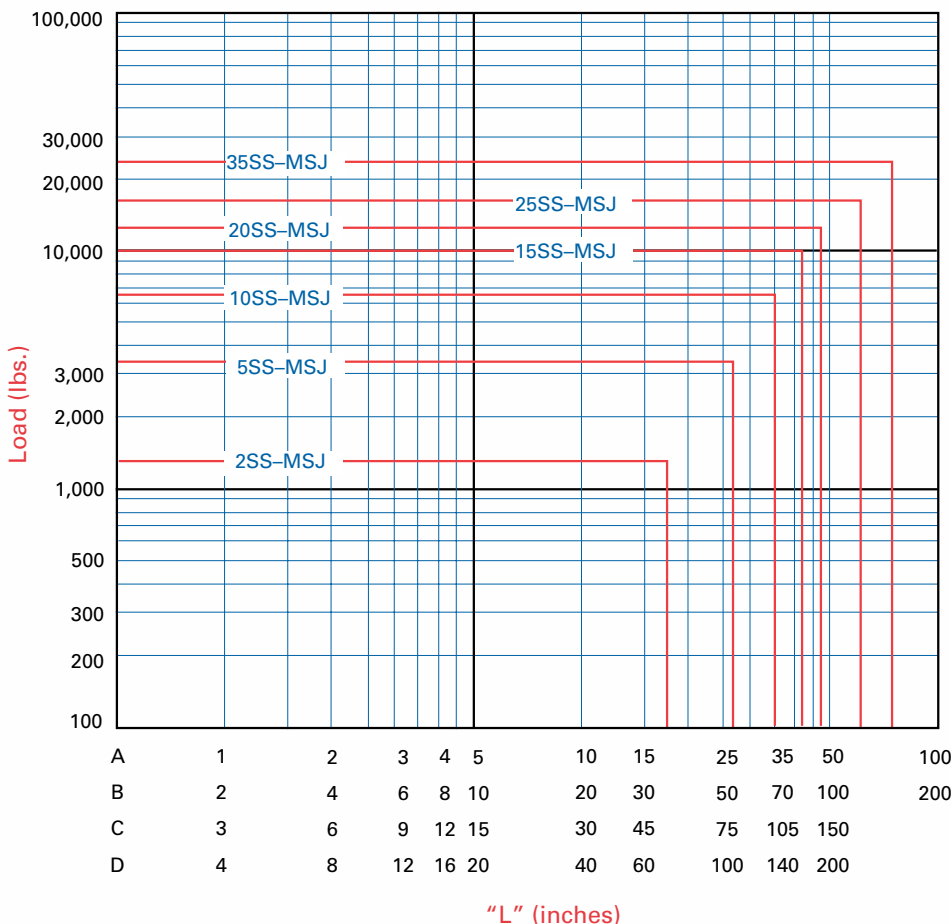

Inch Stainless Steel Machine Screw Jack

MOUNTING CONDITIONS

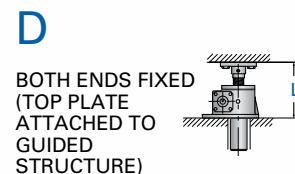
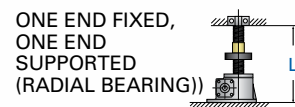
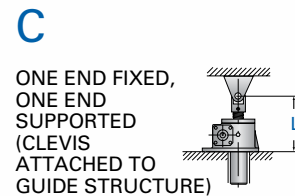
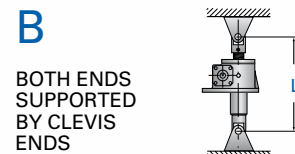

AVAILABLE LIFT SCREW LENGTHS

As a major manufacturer of industrial lead screws, Nook/Thomson stocks a wide selection of stainless acme screws. Nook/Thomson has the capacity to make long acme screws for special applications.

Rotating screw jacks can be built with a larger diameter lift screw for greater column strength, or a different lead to change the jack operating speed.

REFERENCE NUMBER SYSTEM

STAINLESS STEEL JACKS

2SS-MSJ- U 6:1 / SSE-1 / 000-2 / FT / 24.5 / BS

SS MACHINE SCREW MODEL

- Model #
 2SS-MSJ
 5SS-MSJ
 10SS-MSJ
 15SS-MSJ
 20SS-MSJ
 25SS-MSJ
 35SS-MSJ

CONFIGURATION

- U = Upright
 I = Inverted
 UR = Upright Rotating
 IR = Inverted Rotating

GEAR RATIO

Refer to product pages for available ratios.

SHAFT ORDER CODE

SSE - 1

- CCW Position 1
 CW Position 2

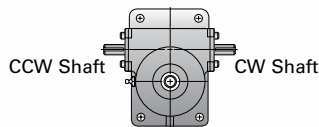

ORDER CODES (Must Include A Position)

NOTE: Both Shaft Extensions Must Be Specified.

No Accessory

- SSE- = Standard Shaft Extension, Position 1 or 2
 000- = Delete Shaft Extension, Position 1 or 2
 SPC- = Special Modified Shaft Extension, Position 1 or 2

HOUSING CONFIGURATION

F = Standard Flange Base

SCREW CONFIGURATION

TRANSLATING - U and I MODELS

- T = Standard Threaded End
 C = Clevis End
 P = Top Plate

ROTATING - UR and IR MODELS

- A = Travel Nut Position "A"
 B = Travel Nut Position "B"

UR - Upright Rotating IR - Inverted Rotating

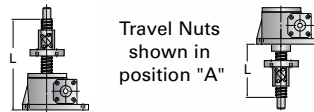

TRAVEL

For Translating Screw Models (U and I) use actual Travel in inches.
 For Rotating Screw Models (UR and IR) use "L" Dimension in inches

MODIFIER LIST

- B and/or H Optional
 B = Bellows Boots (See page 204-205. Must calculate extend and retract length.)
 H = Hardened Worm

 S or M Required
 S = Standard, no additional description required
 M = Modified, additional description required

2SS-MSJ STAINLESS STEEL

2SS-MSJ TOP VIEW

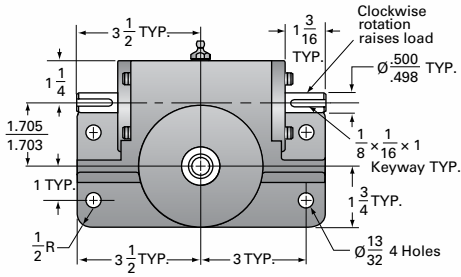

2SS-MSJ-U UPRIGHT

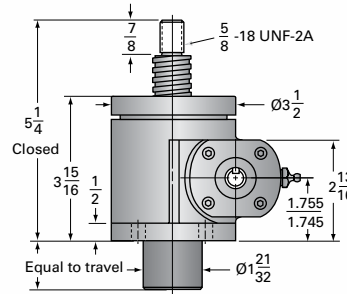

2SS-MSJ-I INVERTED

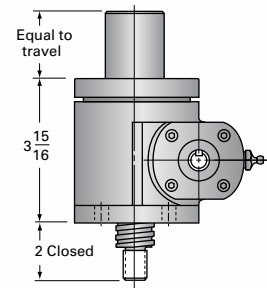

MODEL	Gear Ratio	Capacity* (tons)	Turns of Worm for 1" Travel	Max Input Torque (in-lb)
2SS-MSJ	6:1	0.66	24	33
	24:1	0.66	96	14

* For greater capacity, specify a 17-4PH hardened worm.

- Screw Specs:
- Screw: 1-4
- Root diameter (in): 0.698
- Screw lead (in): 0.250
- Start torque = 2 × Running Torque
- Approximate weight (lbs)
 - "0" Travel: 17.0
 - Per inch travel: 0.5
 - Grease: 0.5

Lifting screw must be secured to prevent rotation for non-keyed units.
Caution: Jack may be self-lowering in some operating conditions.

2SS-MSJ-UR UPRIGHT ROTATING

For ordering, specify "L" dimension
 $L(\text{min}) = \text{travel} + 6\frac{15}{16}$

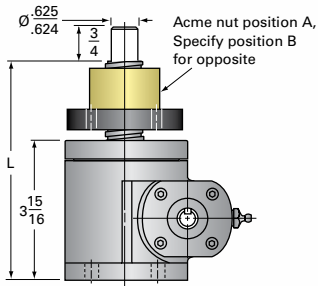

2SS-MSJ-IR INVERTED ROTATING

For ordering, specify "L" dimension
 $L(\text{min}) = \text{travel} + 3$

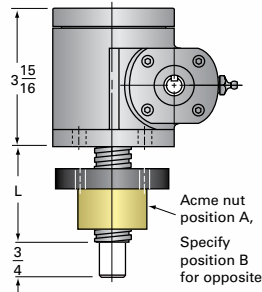

Max Allowable Input (hp)	Tare Drag Torque (in-lb)	Torque to Raise 1 lb (in-lb)	Max Worm Speed at Rated Load (rpm)	Max Load at 1,750 rpm (lb)
2	4	.0250	1,800	1,320
1/2	4	.0150	1,800	1,320

2SS-MSJ Acme Nut and Flange

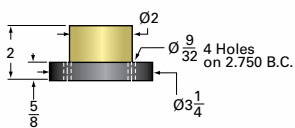

2SS-MSJ Options

Top Plate (optional): 9000-SS-01

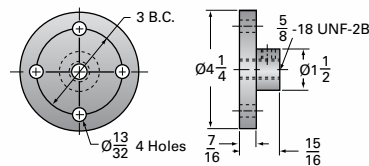

Clevis End (optional): 9001-SS-01

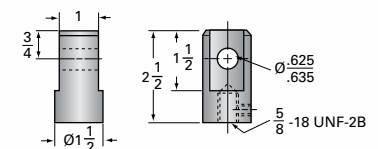

Motor Mounts
 see pg 180-181

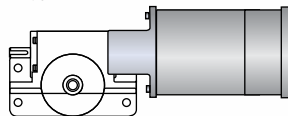

Limit Switch
 see pg 196-201

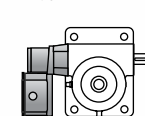

5SS-MSJ STAINLESS STEEL

5SS-MSJ TOP VIEW

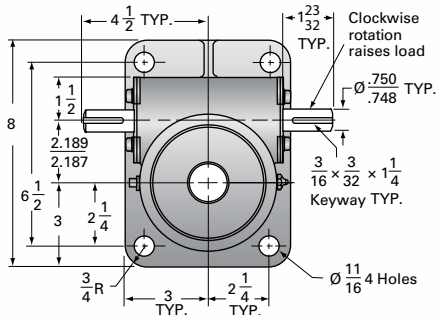

5SS-MSJ-U UPRIGHT

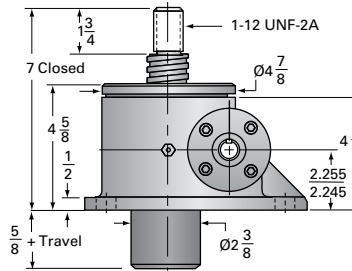

5SS-MSJ-I INVERTED

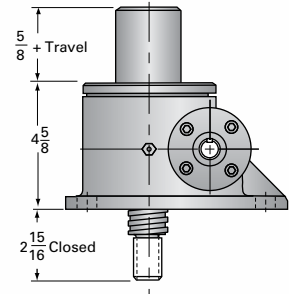

MODEL	Gear Ratio	Capacity* (tons)	Turns of Worm for 1" Travel	Max Input Torque (in-lb)
5SS-MSJ	6:1	1.67	16	125
	24:1	1.67	64	48

* For greater capacity, specify a 17-4PH hardened worm.

Screw Specs:
Screw: 1 1/2-2 3/8
Root diameter (in): 1.066
Screw lead (in): 0.375
Start torque = 2 x Running Torque
Approximate weight (lbs)
 "0" Travel: 32.0
 Per inch travel: .7
Grease: 1.0

Lifting screw must be secured to prevent rotation for non-keyed units.
Caution: Jack may be self-lowering in some operating conditions.

5SS-MSJ-UR UPRIGHT ROTATING

For ordering, specify "L" dimension
 $L(\text{min}) = \text{travel} + 8\frac{5}{8}$

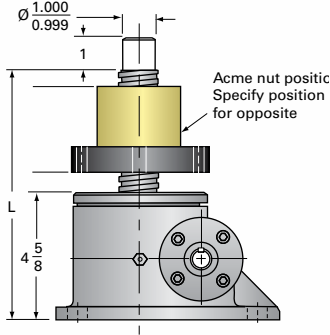

5SS-MSJ-IR INVERTED ROTATING

For ordering, specify "L" dimension
 $L(\text{min}) = \text{travel} + 4$

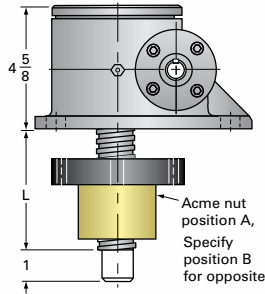

Max Allowable Input (hp)	Tare Drag Torque (in-lb)	Torque to Raise 1 lb (in-lb)	Max Worm Speed at Rated Load (rpm)	Max Load at 1,750 rpm (lb)
3	10	.0376	1,510	2,873
3/4	10	.0144	985	1,875

5SS-MSJ Acme Nut and Flange

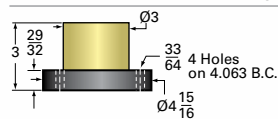

5SS-MSJ Options

Top Plate (optional): 9000-SS-02

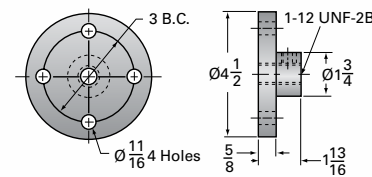

Clevis End (optional): 9001-SS-02

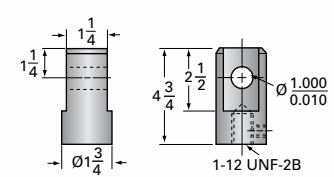

Motor Mounts

see pg 180-181

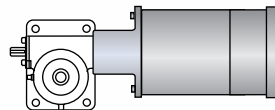

Limit Switch

see pg 196-201

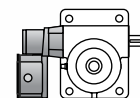

10SS-MSJ STAINLESS STEEL

10SS-MSJ TOP VIEW

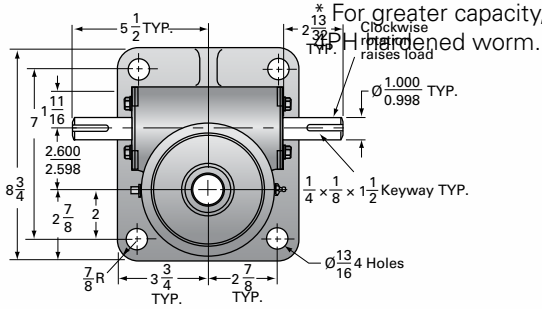

10SS-MSJ-U UPRIGHT

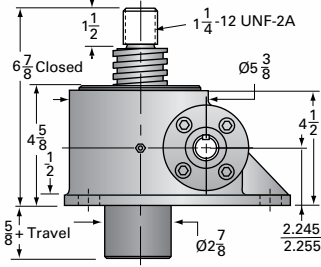

10SS-MSJ-I INVERTED

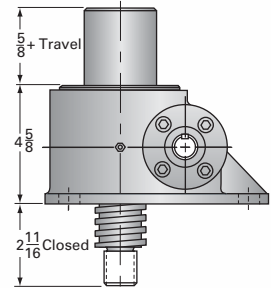

MODEL	Gear Ratio	Capacity* (tons)	Turns of Worm for 1" Travel	Max Input Torque (in-lb)
10SS-MSJ	8:1	3.33	16	251
	24:1	3.33	48	128

* For greater capacity, specify a 17-4PH hardened worm.

- Screw Specs:
- Screw: 2-2
- Root diameter (in): 1.410
- Screw lead (in): 0.500
- Start torque = 2 x Running Torque
- Approximate weight (lbs)
- "0" Travel: 50.0
- Per inch travel: 1.2
- Grease: 1.5

Lifting screw must be secured to prevent rotation for non-keyed units.
 Caution: Jack may be self-lowering in some operating conditions.

10SS-MSJ-UR UPRIGHT ROTATING

For ordering, specify "L" dimension
 $L(\text{min}) = \text{travel} + 8\frac{3}{8}$

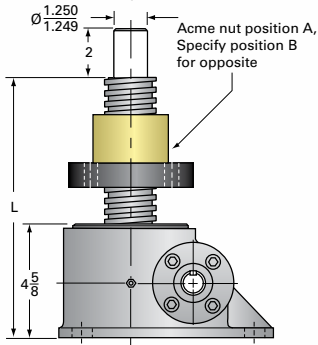

10SS-MSJ-IR INVERTED ROTATING

For ordering, specify "L" dimension
 $L(\text{min}) = \text{travel} + 4$

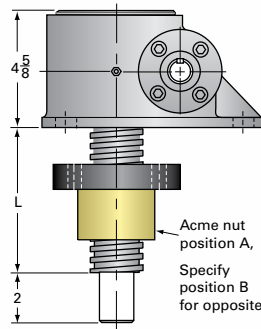

Max Allowable Input (hp)	Tare Drag Torque (in-lb)	Torque to Raise 1 lb (in-lb)	Max Worm Speed at Rated Load (rpm)	Max Load at 1,750 rpm (lb)
5	20	.0377	1,255	4,775
1 1/2	20	.0192	739	2,813

10SS-MSJ Acme Nut and Flange

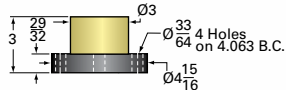

10SS-MSJ Options

Top Plate (optional): 9000-SS-03

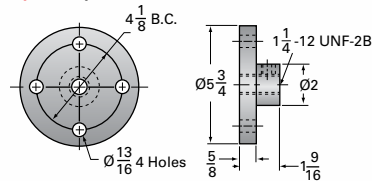

Clevis End (optional): 9001-SS-03

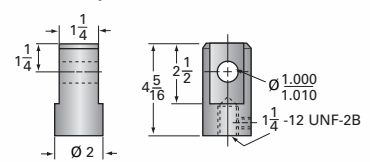

Motor Mounts
 see pg 180-181

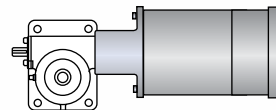

Limit Switch
 see pg 196-201

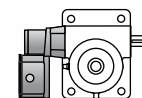

15SS-MSJ STAINLESS STEEL

15SS-MSJ TOP VIEW

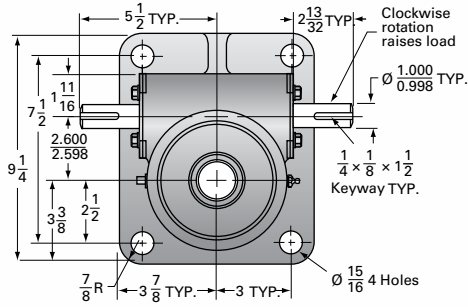

15SS-MSJ-U UPRIGHT

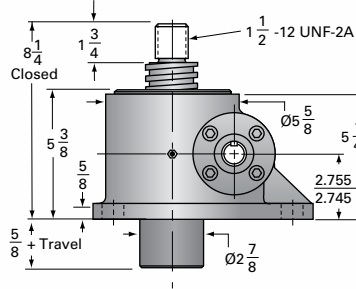

15SS-MSJ-I INVERTED

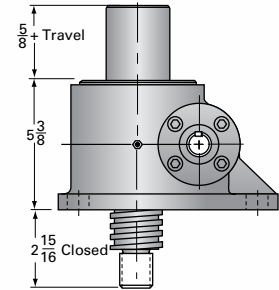

MODEL	Gear Ratio	Capacity* (tons)	Turns of Worm for 1" Travel	Max Input Torque (in-lb)
15SS-MSJ	8:1	5.00	16	407
	24:1	5.00	48	218

* For greater capacity, specify a 17-4PH hardened worm.

Screw Specs:
 Screw: 2 1/4-2
 Root diameter (in): 1.684
 Screw lead (in): 0.500
 Start torque = 2 x Running Torque
 Approximate weight (lbs)
 "0" Travel: 60.0
 Per inch travel: 1.4
 Grease: 1.50

Lifting screw must be secured to prevent rotation for non-keyed units.
 Caution: Jack may be self-lowering in some operating conditions.

15SS-MSJ-UR UPRIGHT ROTATING

For ordering, specify "L" dimension
 $L(\text{min}) = \text{travel} + 9\frac{1}{8}$

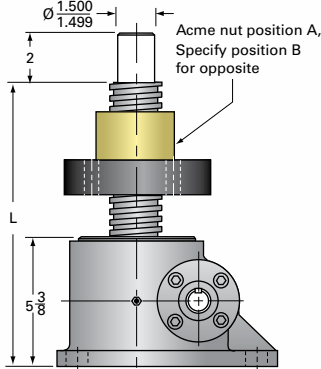

15SS-MSJ-IR INVERTED ROTATING

For ordering, specify "L" dimension
 $L(\text{min}) = \text{travel} + 4\frac{1}{2}$

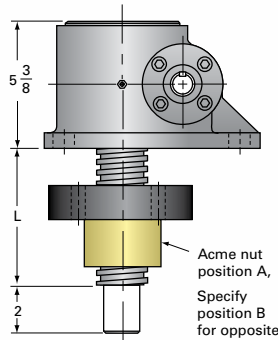

Max Allowable Input (hp)	Tare Drag Torque (in-lb)	Torque to Raise 1 lb (in-lb)	Max Worm Speed at Rated Load (rpm)	Max Load at 1,750 rpm (lb)
5	30	.0407	774	4,424
1 1/2	30	.0218	434	2,478

15SS-MSJ Acme Nut and Flange

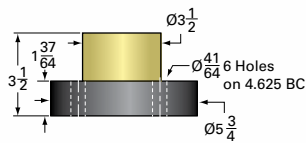

15SS-MSJ Options

Top Plate (optional): 9000-SS-05

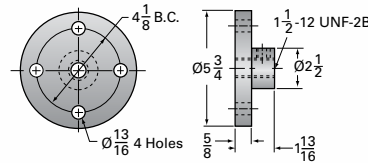

Clevis End (optional): 9001-SS-05

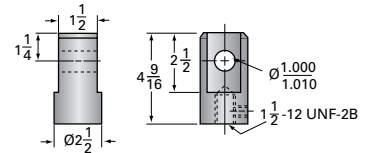

Motor Mounts
 see pg 180-181

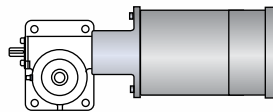

Limit Switch
 see pg 196-201

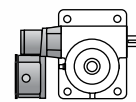

20SS-MSJ STAINLESS STEEL

20SS-MSJ TOP VIEW

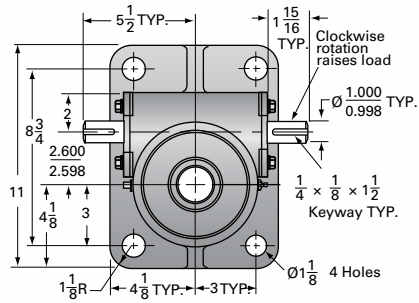

20SS-MSJ-U UPRIGHT

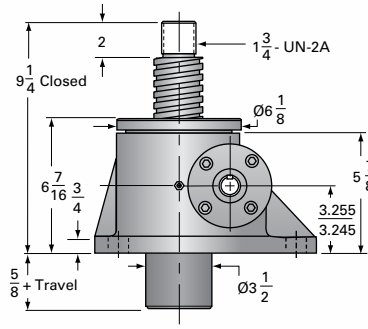

20SS-MSJ-I INVERTED

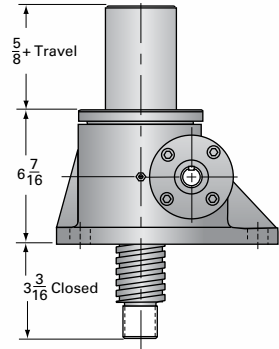

MODEL	Gear Ratio	Capacity* (tons)	Turns of Worm for 1" Travel	Max Input Torque (in-lb)
20SS-MSJ	8:1	6.66	16	580
	24:1	6.66	48	291

* For greater capacity, specify a 17-4PH hardened worm.

- Screw Specs:
- Screw: 2 1/2-2
- Root diameter (in): 1.908
- Screw lead (in): 0.500
- Start torque = 2 × Running Torque
- Approximate weight (lbs)
- "0" Travel: 85.0
- Per inch travel: 2.0
- Grease: 2.25

Lifting screw must be secured to prevent rotation for non-keyed units.
Caution: Jack may be self-lowering in some operating conditions.

20SS-MSJ-UR UPRIGHT ROTATING

For ordering, specify "L" dimension
 $L(\text{min}) = \text{travel} + 10 \frac{13}{16}$

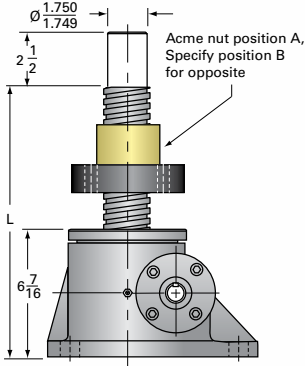

20SS-MSJ-IR INVERTED ROTATING

For ordering, specify "L" dimension
 $L(\text{min}) = \text{travel} + 4 \frac{1}{2}$

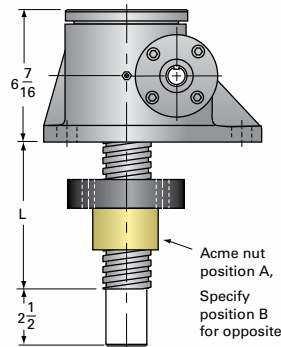

Max Allowable Input (hp)	Tare Drag Torque (in-lb)	Torque to Raise 1 lb (in-lb)	Max Worm Speed at Rated Load (rpm)	Max Load at 1,750 rpm (lb)
5	40	.0435	540	4,140
1 1/2	40	.0218	325	2,478

20SS-MSJ Acme Nut and Flange

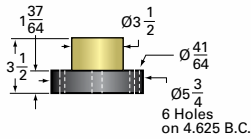

20SS-MSJ Options

Top Plate (optional): 9000-SS-06

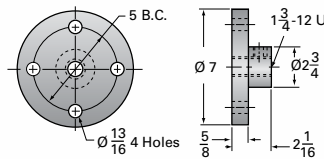

Clevis End (optional): 9001-SS-06

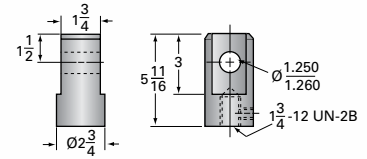

Motor Mounts
 see pg 180-181

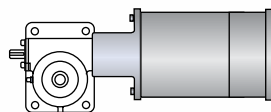

Limit Switch
 see pg 196-201

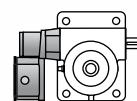

25SS-MSJ STAINLESS STEEL

25SS-MSJ TOP VIEW

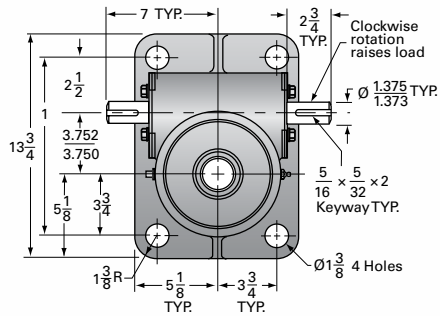

25SS-MSJ-U UPRIGHT

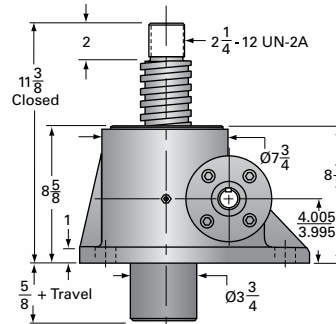

25SS-MSJ-I INVERTED

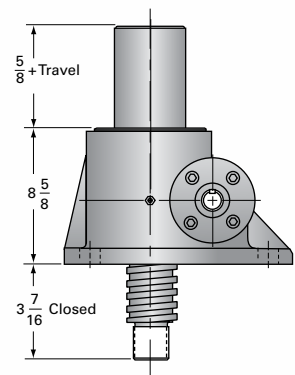

MODEL	Gear Ratio	Capacity* (tons)	Turns of Worm for 1" Travel	Max Input Torque (in-lb)
25SS-MSJ	10 3/8:1	8.30	16	903
	32:1	8.30	48	471

* For greater capacity, specify a 17-4PH hardened worm.

Screw Specs:
 Screw: 3-1 1/2
 Root diameter (in): 2.287
 Screw lead (in): 0.667
 Start torque = 2 x Running Torque
 Approximate weight (lbs)
 "0" Travel: 155.0
 Per inch travel: 3.1
 Grease: 3.50

Lifting screw must be secured to prevent rotation for non-keyed units.
 Caution: Jack may be self-lowering in some operating conditions.

25SS-MSJ-UR UPRIGHT ROTATING

For ordering, specify "L" dimension
 $L(\text{min}) = \text{travel} + 13\frac{21}{32}$

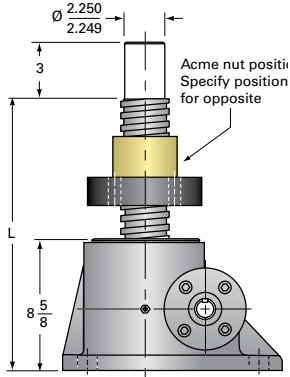

25SS-MSJ-IR INVERTED ROTATING

For ordering, specify "L" dimension
 $L(\text{min}) = \text{travel} + 5\frac{1}{32}$

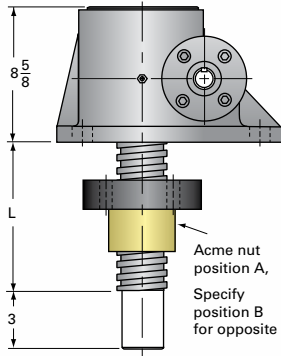

Max Allowable Input (hp)	Tare Drag Torque (in-lb)	Torque to Raise 1 lb (in-lb)	Max Worm Speed at Rated Load (rpm)	Max Load at 1,750 rpm (lb)
11	50	.0452	540	8,764
3 1/2	50	.0235	325	5,364

25SS-MSJ Acme Nut and Flange

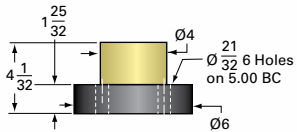

25SS-MSJ Options

Top Plate (optional): 9000-SS-07

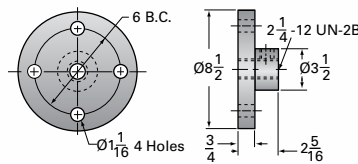

Clevis End (optional): 9001-SS-08

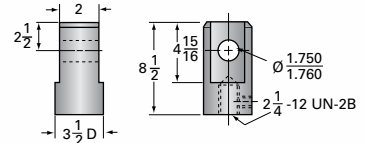

Motor Mounts
 see pg 180-181

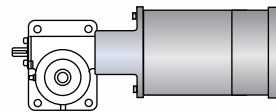

Limit Switch
 see pg 196-201

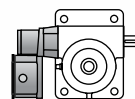

35SS-MSJ STAINLESS STEEL

35SS-MSJ TOP VIEW

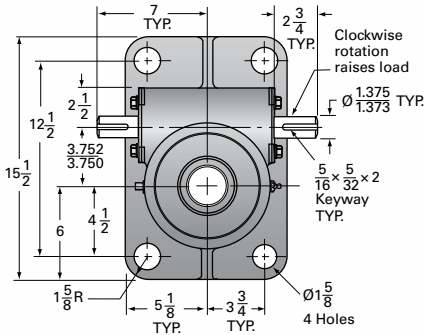

35SS-MSJ-U UPRIGHT

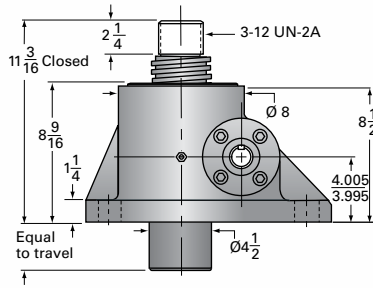

35SS-MSJ-I INVERTED

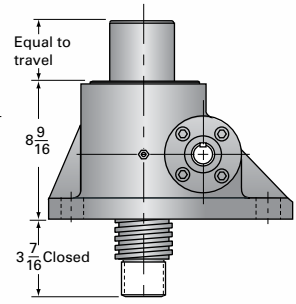

MODEL	Gear Ratio	Capacity* (tons)	Turns of Worm for 1" Travel	Max Input Torque (in-lb)
35SS-MSJ	10 ² / ₃ :1	11.66	16	1,150
	32:1	11.66	48	600

* For greater capacity, specify a 17-4PH hardened worm.

- Screw Specs:
- Screw: 3³/₄-1¹/₂
- Root diameter (in): 3.009
- Screw lead (in): 0.667
- Start torque = 2 × Running Torque
- Approximate weight (lbs)
- "0" Travel: 165.0
- Per inch travel: 3.5
- Grease: 3.50

Lifting screw must be secured to prevent rotation for non-keyed units.
Caution: Jack may be self-lowering in some operating conditions.

35SS-MSJ-UR UPRIGHT ROTATING

For ordering, specify "L" dimension
 $L(\text{min}) = \text{travel} + 15 \frac{1}{16}$

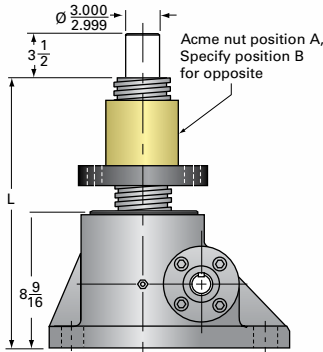

35SS-MSJ-IR INVERTED ROTATING

For ordering, specify "L" dimension
 $L(\text{min}) = \text{travel} + 6 \frac{1}{2}$

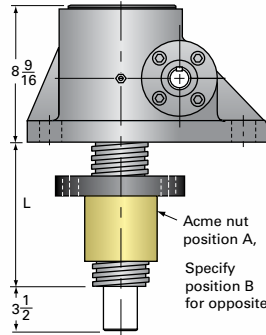

Max Allowable Input (hp)	Tare Drag Torque (in-lb)	Torque to Raise 1 lb (in-lb)	Max Worm Speed at Rated Load (rpm)	Max Load at 1,750 rpm (lb)
11	50	.0493	603	8,035
3 1/2	50	.0251	368	5,022

35SS-MSJ Acme Nut and Flange

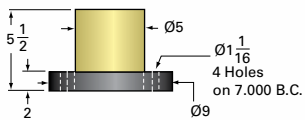

35SS-MSJ Options

Top Plate (optional): 9000-SS-13

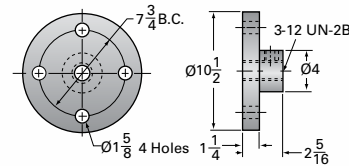

Clevis End (optional): 9001-SS-16

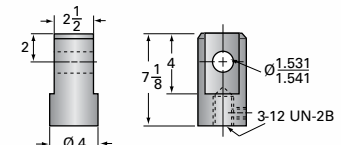

Motor Mounts
 see pg 180-181

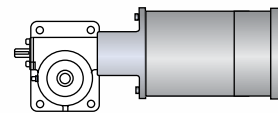

Limit Switch
 see pg 196-201

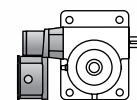

METRIC BALL SCREW JACKS

With over twenty-five years of experience manufacturing precision worm gear screw jacks, Nook/Thomson has expanded the ActionJac™ offering to include metric models providing design engineers a globally accepted product. All the efficiency advantages that come with ball screw technology are available in ActionJac™ Metric Ball Screw Jacks. A full line of IEC motor mounts are also available.

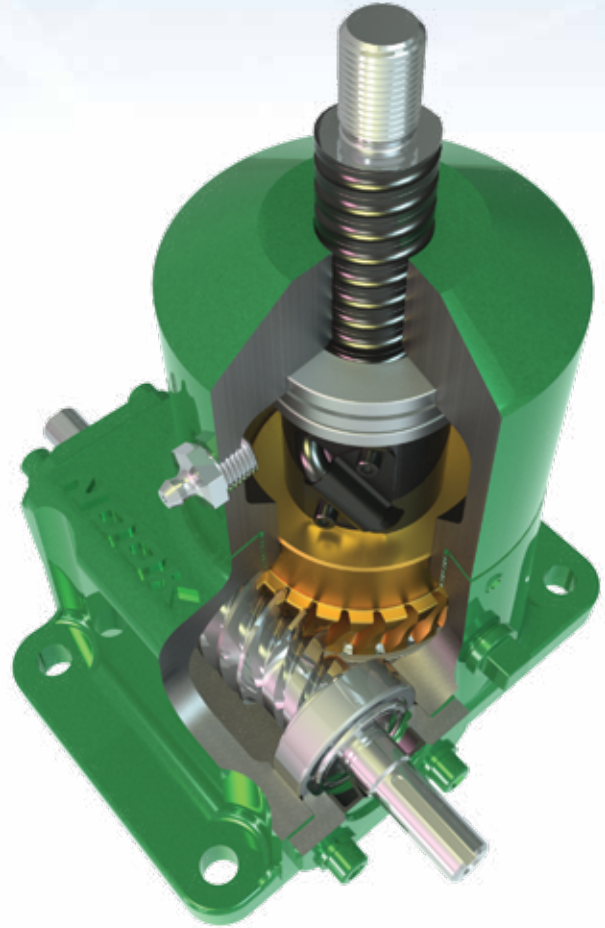

Nook/Thomson metric ball screw jacks used in a wind power application.



METRIC BALL SCREW JACKS 118-123

Quick Reference 120-121
 Column Strength..... 122
 Reference Number System 123

TECHNICAL DATA 124-135

EM05-BSJ..... 124-125
 EM1-BSJ 126-127
 EM2.5-BSJ..... 128-129
 EM5-BSJ..... 130-131
 EM10-BSJ 132-133
 EM20-BSJ..... 134-135



METRIC BALL SCREW JACKS

QUICK REFERENCE

METRIC BALL SCREW JACKS

MODEL	Gear Ratio	Capacity (kN)	Lifting Screw Dia (mm)	Screw Lead (mm)	Root Dia (mm)	Raise for One Turn of Worm (mm)	Max Input Torque (N·m)	Max Input (kW)	Max Worm Speed at Rated Load (rpm)	Max Load at 1,425 rpm (kN)	Torque to Raise 1 kN (N·m)	No Load Torque (N·m)	Back Drive Holding Torque
EM05-BSJ	5:1	5	16	5	12.9	1.00	1.21	0.21	1,625	5.0	0.24	0.11	1.0
	20:1	5	16	5	12.9	0.25	0.51	0.09	1,625	5.0	0.10	0.11	0.5
EM1-BSJ	5:1	10	20	5	17.5	1.00	2.41	0.38	1,500	10.0	0.24	0.34	2.0
	20:1	10	20	5	17.5	0.25	1.14	0.19	1,585	10.0	0.11	0.34	1.0
EM2.5-BSJ	6:1	25	25	5	22.5	0.83	5.05	1.08	2,035	25.0	0.20	0.56	4.5
	12:1	25	25	5	22.5	0.42	3.05	0.65	2,035	25.0	0.12	0.56	2.5
	24:1	25	25	5	22.5	0.21	2.13	0.38	1,695	25.0	0.09	0.56	2.0
EM5-BSJ	6:1	50	40	10	34.8	1.67	19.3	2.28	1,125	39.4	0.39	1.13	16.0
	24:1	50	40	10	34.8	0.42	7.7	0.56	695	24.4	0.15	1.13	6.5
EM10-BSJ	8:1	100	50	10	45.2	1.25	31.9	3.75	1,125	78.9	0.32	2.26	26.0
	24:1	100	50	10	45.2	0.42	16.2	1.12	665	46.6	0.16	2.26	13.5
EM20-BSJ	8:1	200	63	12	57	1.50	75.2	5.6	710	99.8	0.38	4.52	61.0
	24:1	200	63	12	57	0.50	37.7	1.9	470	66.1	0.19	4.52	31.0

NOTES:

- 1) The recommended maximum speed is 3,000 rpm providing that the recommended horsepower and temperature are not exceeded.
- 2) Input torque is shown as torque to lift one kN of load. Starting torque is 50% greater than torque shown. For loads less than 25% of rated loads add tare drag torque.
- 3) Maximum allowable horsepower ratings are based on a 35% duty cycle at standard ambient temperature, with 1 minute on 2 minute off cycles. For operation at higher duty cycles or repeated use over any segment of the total travel, temperature must be monitored and remain less than 95°C.
- 4) Overload capacity of the Metric Ball Screw Jack is as follows: 0% for dynamic loads, 20% for static loads.
- 5) All Ball Screw Jacks can backdrive and require some means of holding the load, such as a brake on the motor. The product specification pages show holding torque values. Holding torque represents the amount of input torque required to restrain the load and does not indicate recommended brake size to bring dynamic load to stop.

6) All units are suitable for intermittent operation providing that the housing temperature including ambient is not lower than -30°C. or higher than +95°C. Factory supplied grease in standard units will operate in this range. For higher or lower operating temperature ranges consult Nook/Thomson.

7) Accessories such as boots, limit switches, top plates and clevises are available.

8) Catalog dimensions are representative only and are subject to change without notice. For construction, use only certified prints.

9) Units are not to be used as personnel support or movement.

10) End-of-travel stops are not provided.

11) ΔStarting torque is 100% greater than torque shown.

$$\text{kW per jack} = \frac{\left(\left(\begin{matrix} \text{Torque to} \\ \text{raise one} \\ \text{kN(N}\cdot\text{m)} \end{matrix} \right) \times \begin{matrix} \text{Number} \\ \text{of kN} \\ \text{to be raised} \end{matrix} \right) + \begin{matrix} \text{Tare} \\ \text{+ Drag} \\ \text{Torque} \end{matrix}}{9,549} \times \text{RPM}$$

12) No load (Tare Drag) torque need only be added if operating under 25% rated load.

LIFE EXPECTENCY

METRIC BALL SCREW JACKS

MODEL	OPERATING LOAD (kN)	METERS OF TRAVEL	
		UPRIGHT & INVERTED	UPRIGHT & INVERTED ROTATING
EM05-BSJ	4	34,295	42,869
	2	274,360	342,950
	1	2,194,880	2,743,600
EM1-BSJ	8	21,455	26,819
	5	87,880	109,850
	2.5	703,040	878,800
EM2.5-BSJ	22	2,793	3,716
	12	18,321	22,901
	6	146,565	183,206
EM5-BSJ	44	28,660	35,825
	22	229,283	286,604
	10	2,441,406	3,051,758
EM10-BSJ	88	6,315	7,894
	44	50,522	63,153
	22	404,178	505,223
EM20-BSJ	170	6,702	8,378
	85	53,618	67,023
	42	444,444	555,555



Nook/Thomson metric ball screw jacks.

METRIC BALL SCREW JACKS

COLUMN STRENGTH

METRIC BALL SCREW JACKS

Column strength is the ability of the lift shaft to hold compressive loads without buckling. With longer screw lengths, column strength may be substantially lower than nominal jack capacity.

If the lift shaft is in tension only, the screw jack travel is limited by the available screw material or by the critical speed of the screw. Refer to the ball screw technical section for critical speed limitations. If there is any possibility for the lift shaft to go into compression, the application should be sized for sufficient column strength.

The chart below is used to determine the required jack size in applications where the lift shaft is loaded in compression.

To use this chart: Find a point at which the maximum length "L" intersects the maximum load. Be sure the jack selected is above and to the right of that point.

CAUTION: Chart does not include a design factor.

The chart assumes proper jack alignment with no bending loads on the screw. Effects from side loading are not included in this chart. Jacks operating horizontally with long lift shafts can experience bending from the weight of the screw.

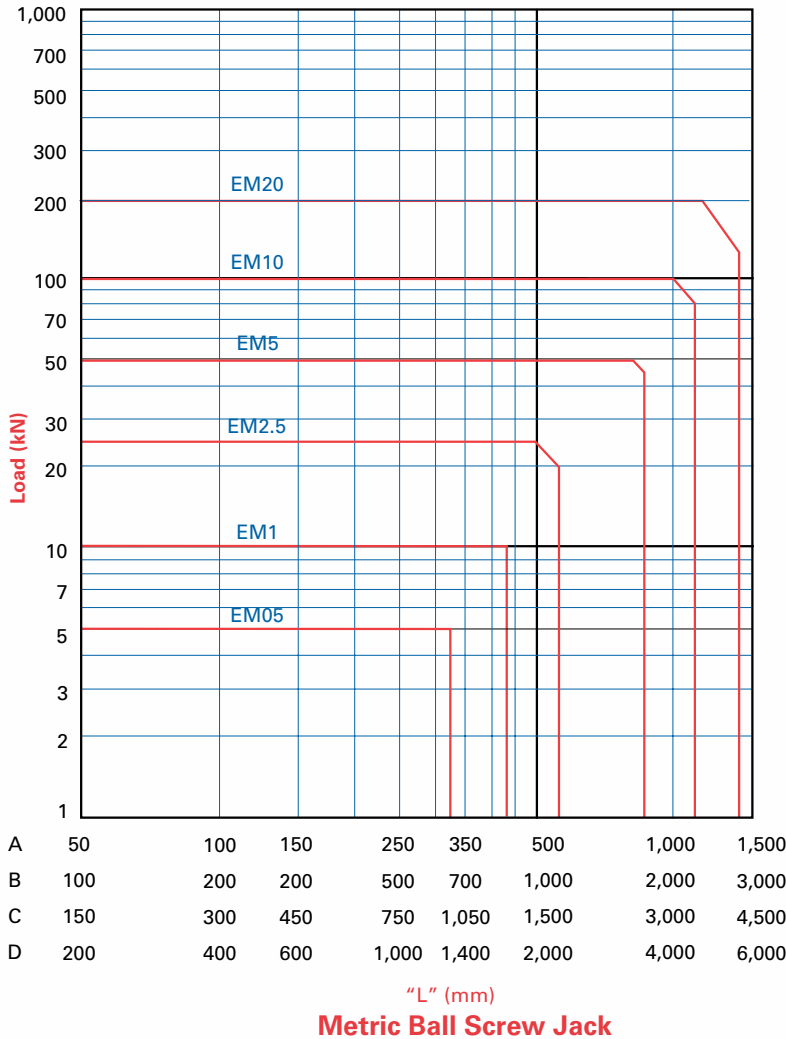

MOUNTING CONDITIONS

A

ONE END FIXED
ONE END FREE

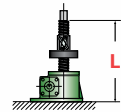

B

BOTH ENDS SUPPORTED BY CLEVIS ENDS

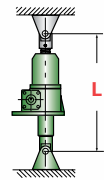

C

ONE END FIXED, ONE END SUPPORTED (CLEVIS ATTACHED TO GUIDE STRUCTURE)

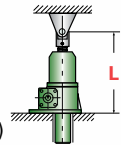

ONE END FIXED, ONE END SUPPORTED (RADIAL BEARING)

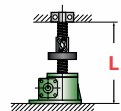

D

BOTH ENDS FIXED (TOP PLATE ATTACHED TO GUIDED STRUCTURE)

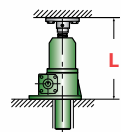

REFERENCE NUMBER SYSTEM

METRIC BALL SCREW JACKS

EM2.5-BSJ- U 6:1 / SSE-1 / 80B5-2 / FT / 580mm / BS

BALL SCREW MODEL

Model #	Model #
EM05-BSJ	EM5-BSJ
EM1-BSJ	EM10-BSJ
EM2.5-BSJ	EM20-BSJ

CONFIGURATION

- U = Upright
- I = Inverted
- UR = Upright Rotating
- IR = Inverted Rotating

GEAR RATIO

Refer to product pages for available ratios.

SHAFT ORDER CODE

SSE - 1

- CCW Position 1
- CW Position 2

ORDER CODES (Must Include A Position)
NOTE: Both Shaft Extensions Must Be Specified.

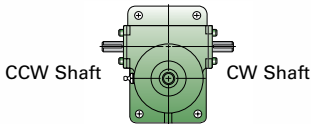

No Accessory

- SSE- = Standard Shaft Extension, Position 1 or 2
- 000- = Delete Shaft Extension, Position 1 or 2
- SPC- = Special Modified Shaft Extension, Position 1 or 2

Motor Mounts Without Motor (Position 1 or 2)

56B5 = EM05	80B5 = EM2.5 and EM5
56B14 = EM05	80B14 = EM2.5 and EM5
63B5 = EM1	90B5 = EM5 and EM10
63B14 = EM1	90B14 = EM5 and EM10
71B5 = EM1 and EM2.5	100B5 = EM10 and EM20
71B14 = EM1 and EM2.5	100B14 = EM10 and EM20

HOUSING CONFIGURATION

F = Standard Flange Base

SCREW CONFIGURATION

TRANSLATING - U and I MODELS
T = Standard Threaded End
C = Clevis End
P = Top Plate

ROTATING - UR and IR MODELS
A = Travel Nut Position "A"
B = Travel Nut Position "B"

UR - Upright Rotating
IR - Inverted Rotating

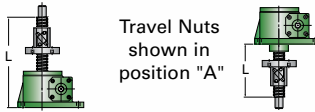

TRAVEL

For Translating Screw Models (U and I) use actual Travel in mm.
For Rotating Screw Models (UR and IR) use "L" Dimension in mm.

MODIFIER LIST

- E and/or B optional
- E = In-Line Encoder (Motor or motor mount is required.)
- B = Bellows Boots (Must calculate retracted and extended boot length. See page 204-205.)
- P = Nook Tube Sensor System PNP
- N = Nook Tube Sensor System NPN
- S or M Required
- S = Standard, no additional description required
- M = Modified, additional description required

METRIC BALL SCREW JACKS



EM05-BSJ

EM05-BSJ TOP VIEW

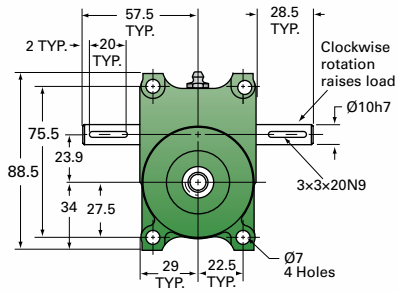

EM05-BSJ-U UPRIGHT

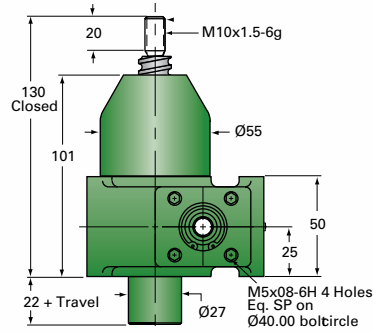

EM05-BSJ-I INVERTED

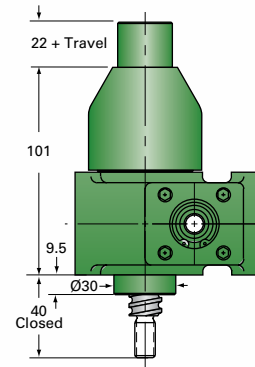

MODEL	Gear Ratio	Capacity (kN)	Raise for One Turn of Worm (mm)	Max Input Torque (N-m)
EM05-BSJ	5:1	5	1.00	1.21
	20:1	5	0.25	0.51

Screw Specs:
 Screw: MRT 16x5
 Root diameter (mm): 12.9
 Drag torque (N-m): 0.11
 Start torque = 1.5 × Running Torque
 Approximate weight (Kg)
 "0" Travel: 1.36
 Per 100mm travel: 0.14
 Grease: 0.14

Caution: Jack is self-lowering. Lifting screw must be secured to prevent rotation for non-keyed units.

EM05-BSJ-UR UPRIGHT ROTATING

For ordering, specify "L" dimension
L(min) = travel + 125

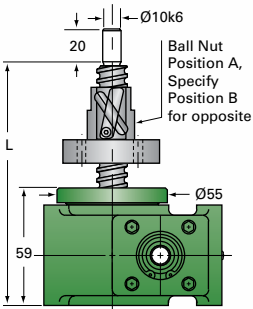

EM05-BSJ-IR INVERTED ROTATING

For ordering, specify "L" dimension
L(min) = travel + 75

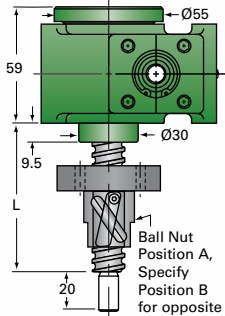

Max Allowable Input (kW)	No Load Torque (N-m)	Backdrive Holding Torque (N-m)	Torque to Raise 1 kN (N-m)	Max Worm Speed at Rated Load (rpm)	Max Load at 1,425 rpm (kN)
0.21	0.11	1.0	.24	1,625	5.0
0.09	0.11	0.5	.10	1,625	5.0

EM05-BSJ Ball Nut and Flange

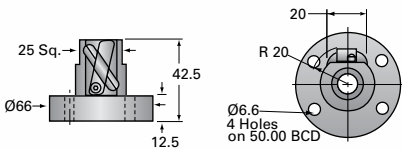

EM05-BSJ Options

Top Plate (optional): 9000-EM-12

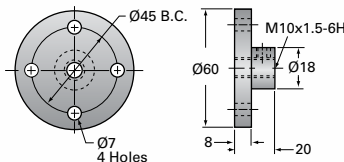

Clevis End (optional): 9001-EM-12

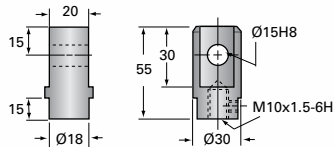

Motor Mounts
see pg 180-181

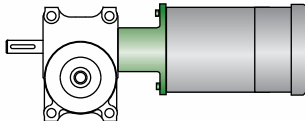

Limit Switch
see pg 196-201

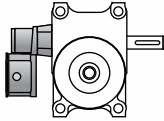

METRIC BALL SCREW JACKS

EM1-BSJ

EM1-BSJ TOP VIEW

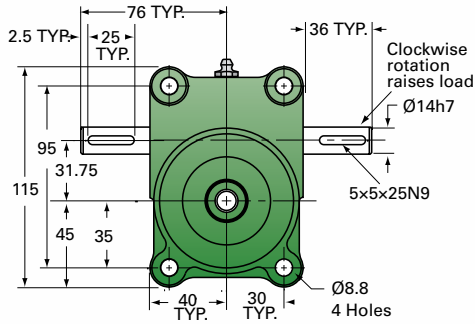

EM1-BSJ-U UPRIGHT

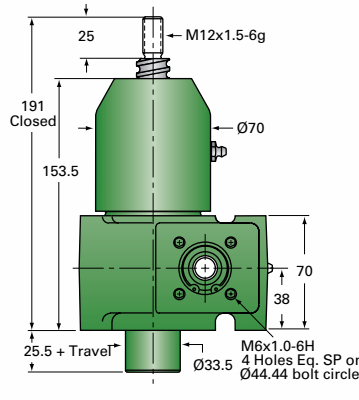

EM1-BSJ-I INVERTED

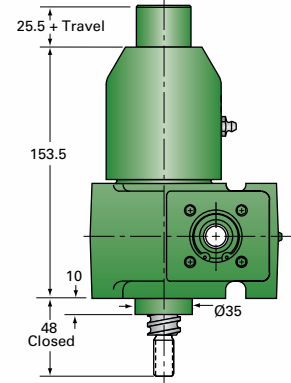

MODEL	Gear Ratio	Capacity (kN)	Raise for One Turn of Worm (mm)	Max Input Torque (N-m)
EM1-BSJ	5:1	10	1.00	2.41
	20:1	10	0.25	1.14

Screw Specs:
 Screw: MRT 20x5
 Root diameter (mm): 17.5
 Drag torque (N-m): 0.34
 Start torque = 1.5 × Running Torque
 Approximate weight (Kg)
 "0" Travel: 3.6
 Per 100mm travel: 0.23
 Grease: 0.23

Caution: Jack is self-lowering. Lifting screw must be secured to prevent rotation for non-keyed units.

EM1-BSJ-UR UPRIGHT ROTATING

For ordering, specify "L" dimension
L(min) = travel + 164

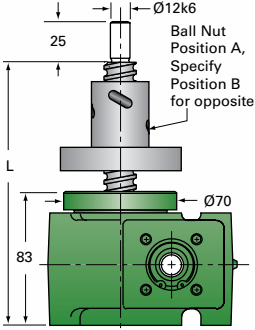

EM1-BSJ-IR INVERTED ROTATING

For ordering, specify "L" dimension
L(min) = travel + 90

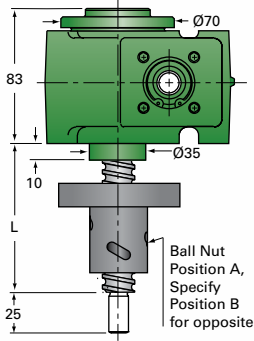

Max Allowable Input (kW)	No Load Torque (N-m)	Backdrive Holding Torque (N-m)	Torque to Raise 1 kN (N-m)	Max Worm Speed at Rated Load (rpm)	Max Load at 1,425 rpm (kN)
0.38	0.34	2.0	.24	1,500	10.0
0.19	0.34	1.0	.11	1,585	10.0

EM1-BSJ Ball Nut and Flange

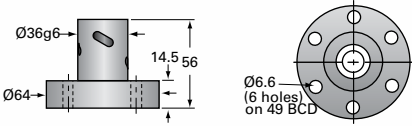

EM1-BSJ Options

Top Plate (optional): 9000-EM-11

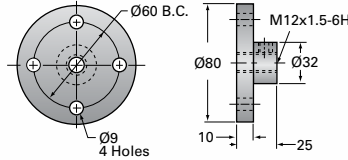

Clevis End (optional): 9001-EM-11

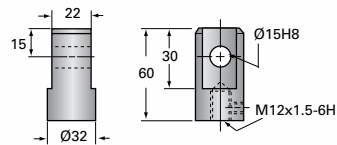

Motor Mounts

see pg 180-181

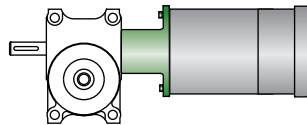

Limit Switch

see pg 196-201

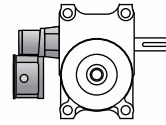

METRIC BALL SCREW JACKS

EM2.5-BSJ

EM2.5-BSJ TOP VIEW

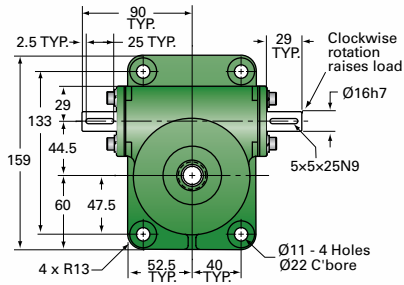

EM2.5-BSJ-U UPRIGHT

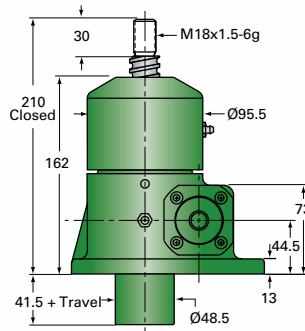

EM2.5-BSJ-I INVERTED

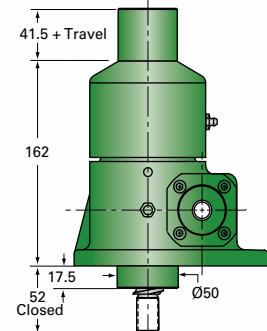

MODEL	Gear Ratio	Capacity (kN)	Raise for One Turn of Worm (mm)	Max Input Torque (N-m)
EM2.5-BSJ	6:1	25	0.83	5.05
	12:1	25	0.42	3.05
	24:1	25	0.21	2.13

Screw Specs:
 Screw: MRT 25x5
 Root diameter (mm): 17.5
 Drag torque (N-m): 0.56
 Start torque = 1.5 × Running Torque
 Approximate weight (Kg)
 "0" Travel: 7.7
 Per 100mm travel: 0.36
 Grease: 0.22

Caution: Jack is self-lowering. Lifting screw must be secured to prevent rotation for non-keyed units.

EM2.5-BSJ-UR UPRIGHT ROTATING

For ordering, specify "L" dimension
L(min) = travel + 186

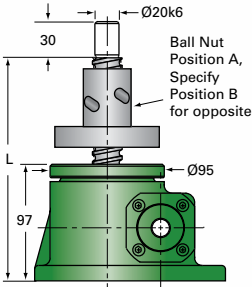

EM2.5-BSJ-IR INVERTED ROTATING

For ordering, specify "L" dimension
L(min) = travel + 107

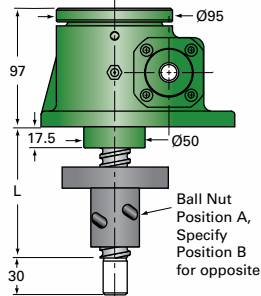

Max Allowable Input (kW)	No Load Torque (N-m)	Backdrive Holding Torque (N-m)	Torque to Raise 1 kN (N-m)	Max Worm Speed at Rated Load (rpm)	Max Load at 1,425 rpm (kN)
1.08	0.56	4.5	0.20	2,035	25.0
0.65	0.56	2.5	0.12	2,035	25.0
0.38	0.56	2.0	0.09	1,695	25.0

EM2.5-BSJ Ball Nut and Flange

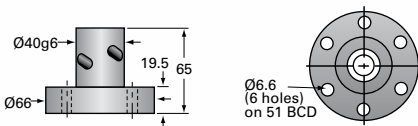

EM2.5-BSJ Options

Top Plate (optional): 9000-EM-01

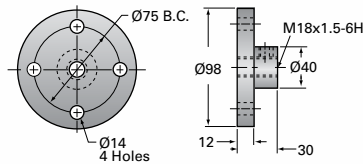

Clevis End (optional): 9001-EM-01

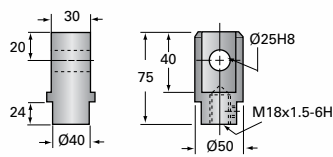

Motor Mounts
see pg 180-181

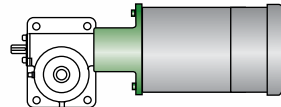

Limit Switch
see pg 196-201

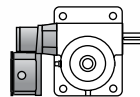

METRIC BALL SCREW JACKS

EM5-BSJ

EM5-BSJ TOP VIEW

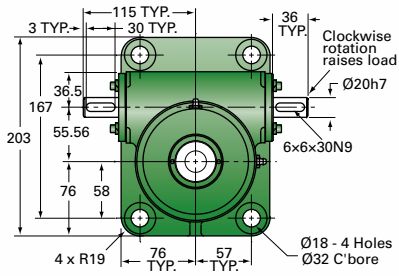

EM5-BSJ-U UPRIGHT

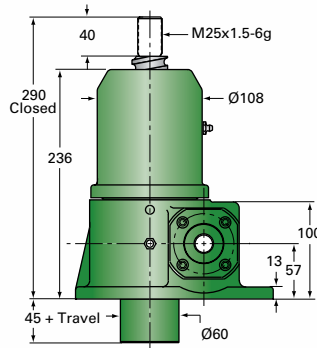

EM5-BSJ-I INVERTED

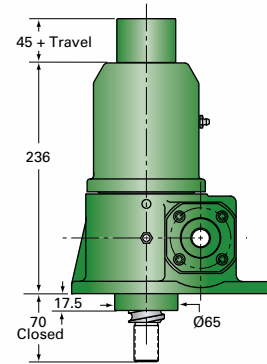

MODEL	Gear Ratio	Capacity (kN)	Raise for One Turn of Worm (mm)	Max Input Torque (N-m)
EM5-BSJ	6:1	50	1.67	19.3
	24:1	50	0.42	7.7

Screw Specs:
 Screw: MRT 40x10
 Root diameter (mm): 34.8
 Drag torque (N-m): 1.13
 Start torque = 1.5 × Running Torque
 Approximate weight (Kg)
 "0" Travel: 15.9
 Per 100mm travel: 0.93
 Grease: 0.45

Caution: Jack is self-lowering. Lifting screw must be secured to prevent rotation for non-keyed units.

EM5-BSJ-UR UPRIGHT ROTATING

For ordering, specify "L" dimension
 L(min) = travel + 260

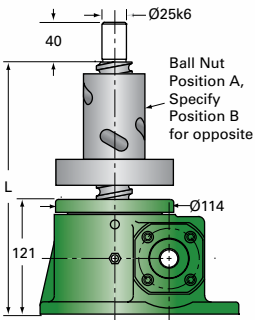

EM5-BSJ-IR INVERTED ROTATING

For ordering, specify "L" dimension
 L(min) = travel + 157

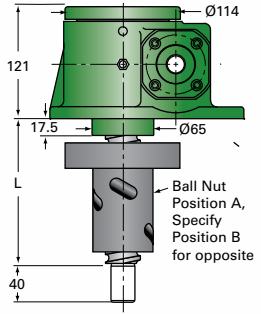

Max Allowable Input (kW)	No Load Torque (N-m)	Backdrive Holding Torque (N-m)	Torque to Raise 1 kN (N-m)	Max Worm Speed at Rated Load (rpm)	Max Load at 1,425 rpm (kN)
2.28	1.13	16.0	0.39	1,125	39.4
0.56	1.13	6.5	0.15	695	24.4

EM5-BSJ Ball Nut and Flange

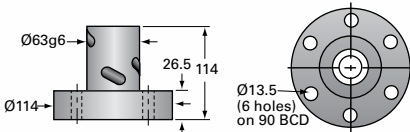

EM5-BSJ Options

Top Plate (optional): 9000-EM-02

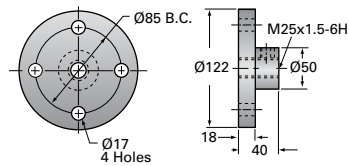

Clevis End (optional): 9001-EM-02

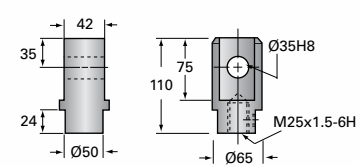

Motor Mounts
 see pg 180-181

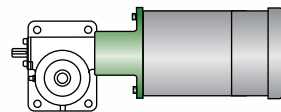

Limit Switch
 see pg 196-201

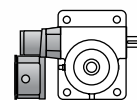

METRIC BALL SCREW JACKS

EM10-BSJ

EM10-BSJ TOP VIEW

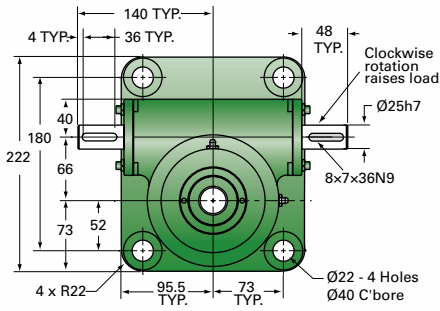

EM10-BSJ-U UPRIGHT

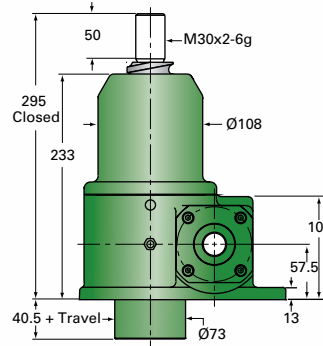

EM10-BSJ-I INVERTED

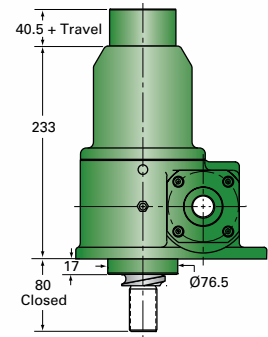

MODEL	Gear Ratio	Capacity (kN)	Raise for One Turn of Worm (mm)	Max Input Torque (N-m)
EM10-BSJ	6:1	100	1.25	31.9
	24:1	100	0.42	16.2

Screw Specs:
 Screw: MRT 50x10
 Root diameter (mm): 45.2
 Drag torque (N-m): 2.26
 Start torque = 1.5 × Running Torque
 Approximate weight (Kg)
 "0" Travel: 22.7
 Per 100mm travel: 1.46
 Grease: 0.68

Caution: Jack is self-lowering. Lifting screw must be secured to prevent rotation for non-keyed units.

EM10-BSJ-UR UPRIGHT ROTATING
For ordering, specify "L" dimension
L(min) = travel + 283

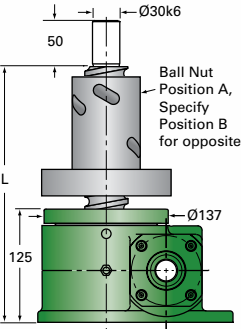

EM10-BSJ-IR INVERTED ROTATING
For ordering, specify "L" dimension
L(min) = travel + 173

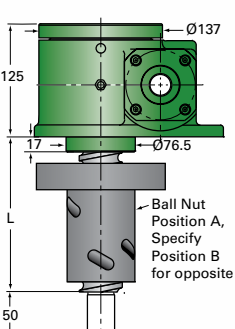

Max Allowable Input (kW)	No Load Torque (N-m)	Backdrive Holding Torque (N-m)	Torque to Raise 1 kN (N-m)	Max Worm Speed at Rated Load (rpm)	Max Load at 1,425 rpm (kN)
3.75	2.26	26.0	0.32	1,125	78.9
1.12	2.26	13.5	0.16	665	46.6

EM10-BSJ Ball Nut and Flange

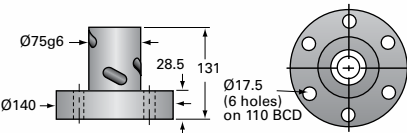

EM10-BSJ Options

Top Plate (optional): 9000-EM-04

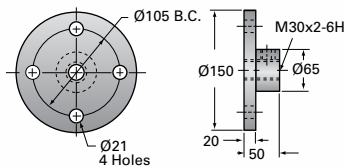

Clevis End (optional): 9001-EM-04

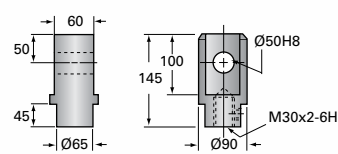

Motor Mounts
see pg 180-181

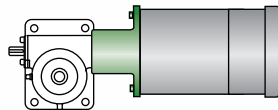

Limit Switch
see pg 196-201

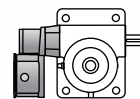

METRIC BALL SCREW JACKS

EM20-BSJ

EM20-BSJ TOP VIEW

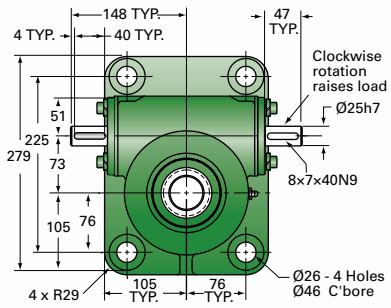

EM20-BSJ-U UPRIGHT

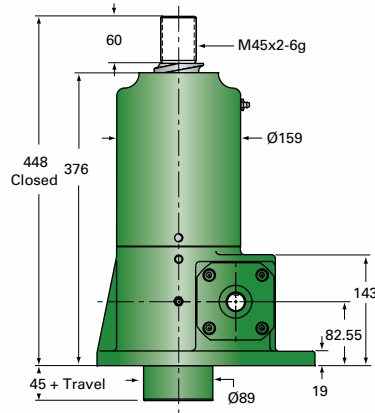

EM20-BSJ-I INVERTED

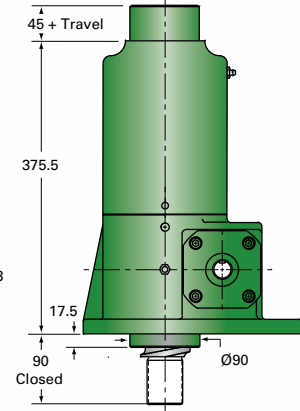

MODEL	Gear Ratio	Capacity (kN)	Raise for One Turn of Worm (mm)	Max Input Torque (N-m)
EM20-BSJ	8:1	200	1.5	75.2
	24:1	200	0.5	37.7

Screw Specs:
 Screw: MRT 63x12
 Root diameter (mm): 56.98
 Drag torque (N-m): 4.52
 Start torque = 1.5 × Running Torque
 Approximate weight (Kg)
 "0" Travel: 38.6
 Per 100mm travel: 2.31
 Grease: 1.0

Caution: Jack is self-lowering. Lifting screw must be secured to prevent rotation for non-keyed units.

EM20-BSJ-UR UPRIGHT ROTATING

For ordering, specify "L" dimension
L(min) = travel + 370

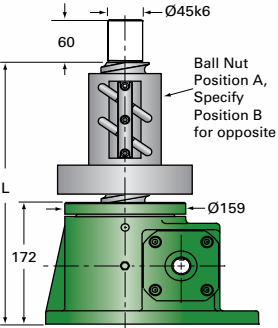

EM20-BSJ-IR INVERTED ROTATING

For ordering, specify "L" dimension
L(min) = travel + 215

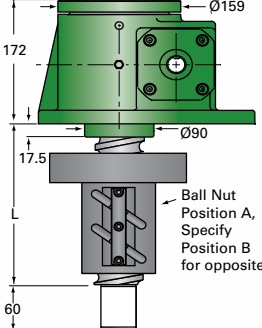

Max Allowable Input (kW)	No Load Torque (N-m)	Backdrive Holding Torque (N-m)	Torque to Raise 1 kN (N-m)	Max Worm Speed at Rated Load (rpm)	Max Load at 1,425 rpm (kN)
5.6	4.52	61.0	0.38	710	99.8
1.9	4.52	31.0	0.19	470	66.1

EM20-BSJ Ball Nut and Flange

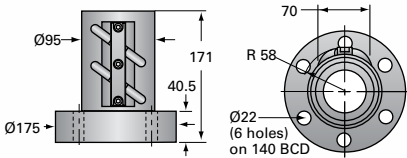

EM20-BSJ Options

Top Plate (optional): 9000-EM-06

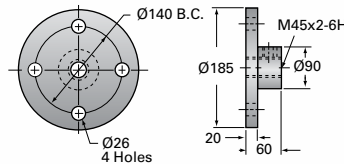

Clevis End (optional): 9001-EM-06

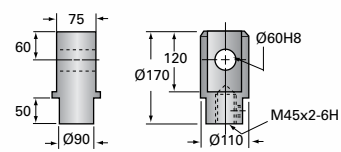

Motor Mounts
see pg 180-181

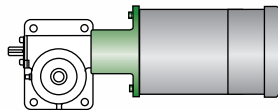

Limit Switch
see pg 196-201

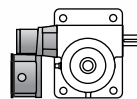

METRIC BALL SCREW JACKS

METRIC TRAPEZOIDAL MACHINE SCREW JACKS

ActionJac™ Metric Trapezoidal Screw Jacks utilize the same rugged design as the ActionJac™ Machine Screw Jacks. These true metric jacks include a lift shaft with a special trapezoidal thread form. This thread form has been created to stay within ISO standards yet retains the centralizing feature of our 2C acme threads. These jacks may be assembled with IEC motor mounts.

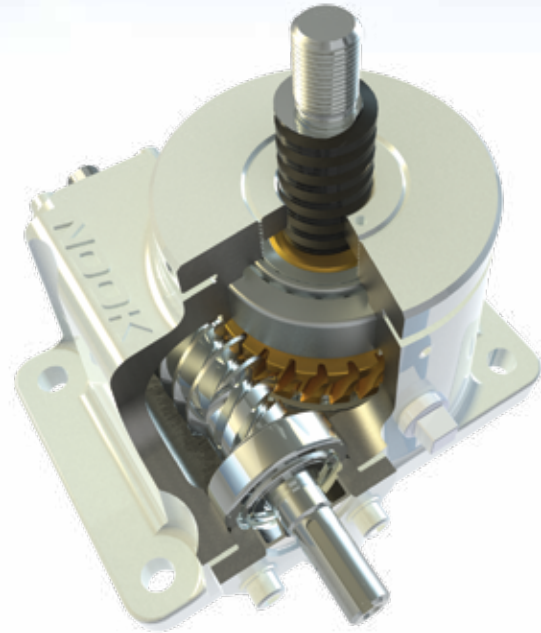

Nook/Thomson worm gear screw jacks are used widely in the nuclear industry.



TRAPEZOIDAL SCREW JACKS 136-141

..... Quick Reference
138-139
..... Column Strength
140
..... Reference Number System
141

TRAPEZOIDAL SCREW JACKS TECHNICAL DATA 142-153

..... EM05-MSJ
142-143
..... EM1-MSJ
144-145
..... EM2.5-MSJ
146-147
..... EM5-MSJ
148-149
..... EM10-MSJ
150-151
..... EM20-MSJ
152-153

QUICK REFERENCE

METRIC TRAPEZOIDAL SCREW JACKS

MODEL	Gear Ratio	Capacity (kN)	Lifting Screw Dia (mm)	Screw Lead (mm)	Root Dia (mm)	Raise for One Turn of Worm (mm)	Max Input Torque (N·m)	Max Input (kW)	Max Worm Speed at Rated Load (rpm)	Max Load at 1,425 rpm (kN)	Torque to Raise 1 kN (N·m)	No Load Torque (N·m)
EM05-MSJ	5:1	5	16	4	10.9	0.80	2.25	0.27	1,130	4.0	0.45	0.11
	20:1	5	16	4	10.9	0.20	0.94	0.13	1,130	4.6	0.19	0.11
EM1-MSJ	5:1	10	20.0	5	17.5	0.80	5.19	0.36	665	4.7	0.52	0.34
	20:1	10	20.0	5	17.5	0.20	2.44	0.19	730	5.1	0.24	0.34
EM2.5-MSJ	6:1	25	26	6	17.8	1.0	14.9	1.51	975	17.0	0.59	0.56
	24:1	25	26	6	17.8	0.25	6.3	0.38	575	10.1	0.25	0.56
EM5-MSJ	6:1	50	40	7	30.9	1.17	40.3	1.87	445	15.6	0.81	1.13
	24:1	50	40	7	30.9	0.29	16.0	0.51	300	10.7	0.32	1.13
EM10-MSJ	8:1	100	55	12	40.0	1.50	97.2	3.65	360	25.2	0.97	2.26
	24:1	100	55	12	40.0	0.50	215	5.60	250	14.8	0.50	2.26
EM20-MSJ	8:1	200	65	12	50.0	1.50	215	5.60	250	35.0	1.08	4.52
	24:1	200	65	12	50.0	0.50	108	1.9	165	23.0	0.54	4.52

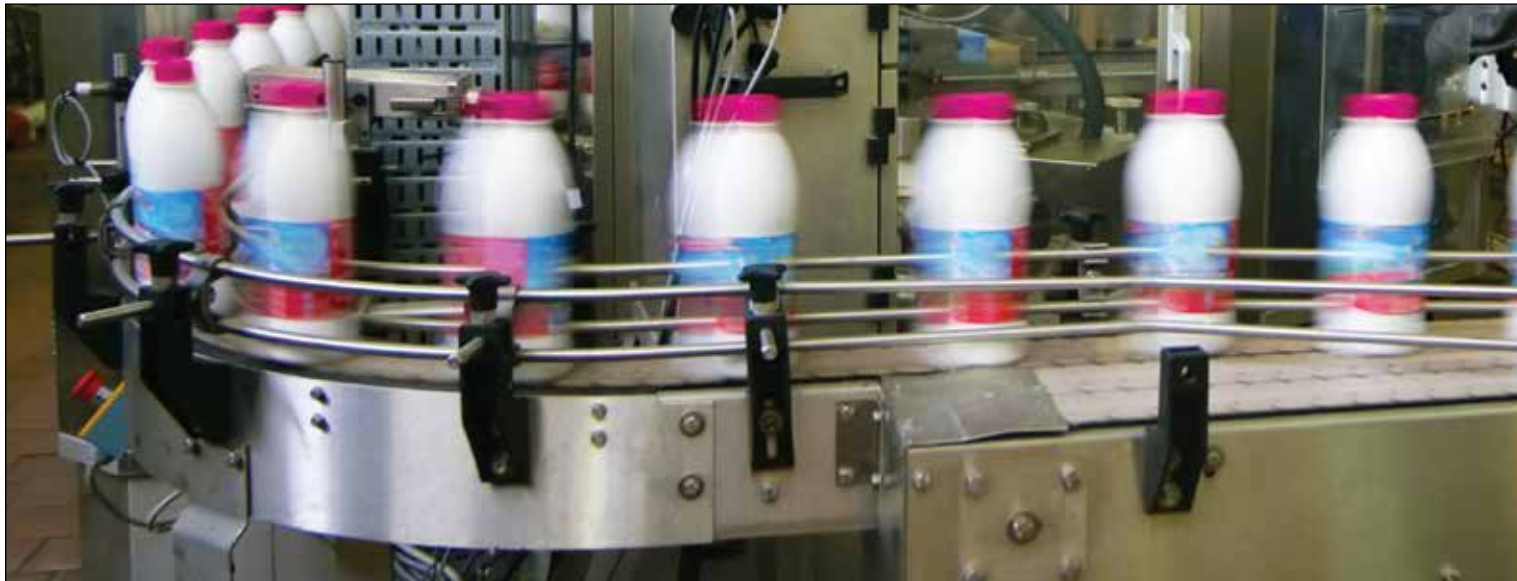

Nook/Thomson worm gear screw jacks are used in many conveyor applications.

NOTES:

- 1) The recommended maximum speed is 1,800 rpm providing the recommended horsepower and temperature are not exceeded.
- 2) Input torque is shown as torque to lift one kN of load. Starting torque is 100% greater than torque shown. Forloads less than 25% of rated loads add tare drag torque.
- 3) Maximum allowable power ratings are based on a 25% duty cycle at standard ambient temperature, with 1 minute on 2 minute off cycles. For operation at higher duty cycles or repeated use over any segment of the total travel, temperature must be monitored and remain less than 95°C.
- 4) Overload capacity of the Trapezoidal Screw Jack is as follows: 10% for dynamic loads, 30% for static loads.
- 5) Trapezoidal Screw Jacks having gear ratios between 20:1 and 32:1, are self-locking and will hold loads without backdriving in the absence of vibrations. All other ratios may require a brake to prevent backdriving.
- 6) All units are suitable for intermittent operation providing that the housing temperature including ambient is not lower than -30°C. or higher than +95°C. Factory supplied grease in standard units will operate in this range. For higher or lower operating temperature ranges consult Nook/Thomson.

- 7) Accessories such as boots, limit switches, top plates and clevises are available.
- 8) Catalog dimensions are representative only and are subject to change without notice. For construction, use only certified prints.
- 9) Units are not to be used as personnel support or movement.
- 10) End-of-travel stops are not provided.
- 11) Starting torque is 100% greater than torque shown.

$$\text{kW per jack} = \frac{\left(\begin{array}{l} \text{Torque to} \\ \text{raise one} \\ \text{kN(N} \cdot \text{m)} \end{array} \times \begin{array}{l} \text{Number} \\ \text{of kN} \\ \text{to be raised} \end{array} \right) + \begin{array}{l} \text{Tare} \\ \text{+ Drag} \\ \text{Torque} \end{array}}{9,549} \times \text{RPM}$$

- 12) No load torque need only be added if operating under 25% rated load.



Nook/Thomson worm gear screw jacks used in a solar application.

COLUMN STRENGTH

METRIC TRAPEZOIDAL SCREW JACKS

Column strength is the ability of the lift shaft to hold compressive loads without buckling. With longer screw lengths, column strength may be substantially lower than nominal jack capacity.

If the lift shaft is in tension only, the screw jack travel is limited by the available screw material or by the critical speed of the screw. Refer to the trapezoidal screw technical section for critical speed limitations. If there is any possibility for the lift shaft to go into compression, the application should be sized for sufficient column strength.

The chart below is used to determine the required jack size in applications where the lift shaft is loaded in compression.

TO USE THIS CHART:

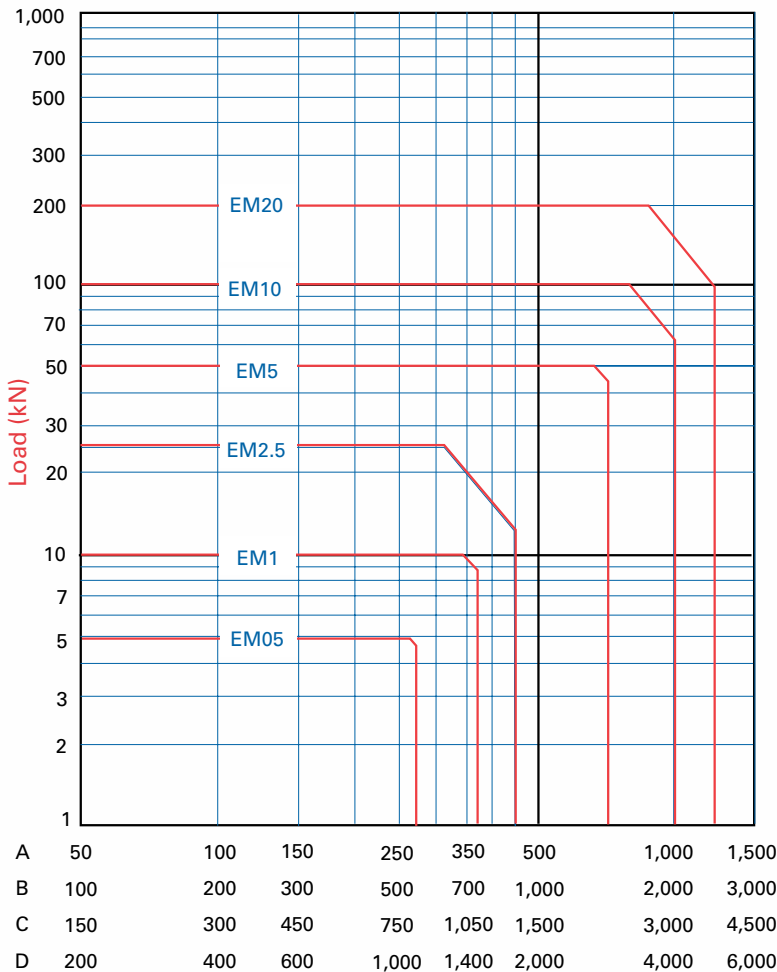

"L" (mm)
Metric Trapezoidal Screw Jacks

AVAILABLE LIFT SCREW LENGTHS

As a major manufacturer of industrial lead screws, Nook/Thomson stocks a wide selection of trapezoidal screws. Nook/Thomson has the capacity to make long trapezoidal screws for special applications.

Find a point at which the maximum length "L" intersects the maximum load. Be sure the jack selected is above and to the right of that point.

CAUTION: chart does not include a design factor.

The chart assumes proper jack alignment with no bending loads on the screw. Effects from side loading are not included in this chart. Jacks operating horizontally with long lift shafts can experience bending from the weight of the screw.

MOUNTING CONDITIONS

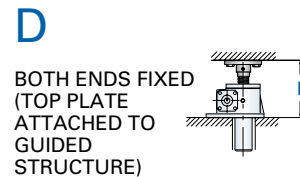
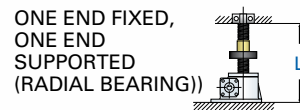
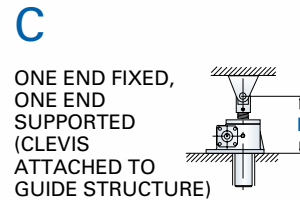
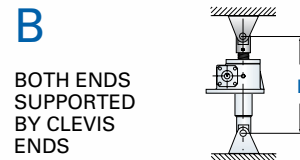

Rotating screw jacks can be built with a larger diameter lift shaft for greater column strength.

REFERENCE NUMBER SYSTEM

METRIC TRAPEZOIDAL SCREW JACKS

EM2.5-MSJ- U 6:1 / SSE-1 / 80B5-2 / FT / 580mm / BS

TRAPEZOIDAL SCREW MODEL

Model #	Model #
EM05-MSJ	EM5-MSJ
EM1-MSJ	EM10-MSJ
EM2.5-MSJ	EM20-MSJ

CONFIGURATION

U = Upright
 I = Inverted
 UR = Upright Rotating
 IR = Inverted Rotating

GEAR RATIO

Refer to product pages for available ratios.

SHAFT ORDER CODE

SSE - 1

CCW Position 1
 CW Position 2

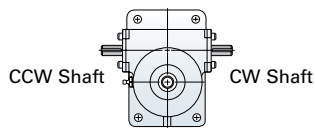

ORDER CODES (Must Include A Position)

NOTE: Both Shaft Extensions Must Be Specified.

No Accessory

SSE- = Standard Shaft Extension, Position 1 or 2
 000- = Delete Shaft Extension, Position 1 or 2
 SPC- = Special Modified Shaft Extension, Position 1 or 2

Motor Mounts Without Motor

(Position 1 or 2)

56B5	= EM05
56B14	= EM05
63B5	= EM1
63B14	= EM1
71B5	= EM1 and EM2.5
71B14	= EM1 and EM2.5
80B5	= EM2.5 and EM5
80B14	= EM2.5 and EM5
90B5	= EM5 and EM10
90B14	= EM5 and EM10
100B5	= EM10 and EM20
100B14	= EM10 and EM20

HOUSING CONFIGURATION

F = Standard Flange Base

SCREW CONFIGURATION

TRANSLATING - U and I MODELS

T = Standard Threaded End
 C = Clevis End
 P = Top Plate

ROTATING - UR and IR MODELS

A = Travel Nut Position "A"
 B = Travel Nut Position "B"

UR - Upright Rotating IR - Inverted Rotating

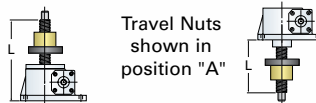

TRAVEL

For Translating Screw Models (U and I) use actual Travel in mm.
 For Rotating Screw Models (UR and IR) use "L" Dimension in mm.

MODIFIER LIST

E and/or B Optional
 E = In-Line Encoder (Motor or motor mount is required.)
 B = Bellows Boots (Must calculate retracted and extended boot length. See page 204-205)
 P = Nook Tube Sensor System PNP
 N = Nook Tube Sensor System NPN

S or M Required

S = Standard, no additional description required
 M = Modified, additional description required



EM05-MSJ

EM05-MSJ TOP VIEW

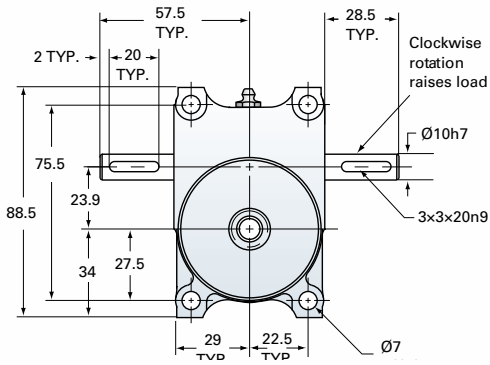

EM05-MSJ-U UPRIGHT

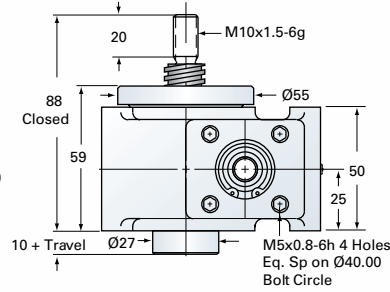

EM05-MSJ-I INVERTED

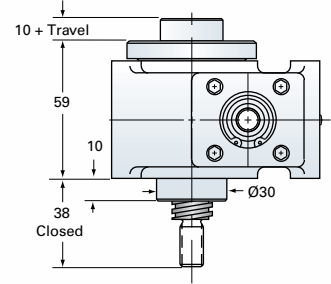

MODEL	Gear Ratio	Capacity (kN)	Raise for One Turn of Worm (mm)	Max Input Torque (N-m)
EM05-MSJ	5:1	5	0.80	2.25
	20:1	5	0.21	0.94

Screw Specs:
 Screw: Tr16x4
 Root diameter (mm): 10.9
 Start torque = 2 × Running Torque
 Approximate weight (Kg)
 "0" Travel: 1.13
 Per 100mm travel: 0.12
 Grease: 0.23

Lifting screw must be secured to prevent rotation for non-keyed units.
 Caution: Jack may be self-lowering in some operating conditions.

EM05-MSJ-UR UPRIGHT ROTATING

For ordering, specify "L" dimension
L(min) = travel + 111

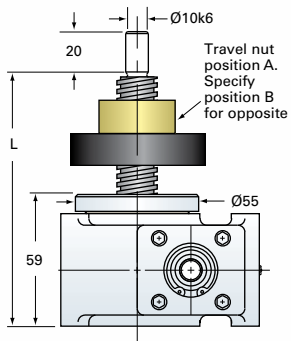

EM05-MSJ-IR INVERTED ROTATING

For ordering, specify "L" dimension
L(min) = travel + 61

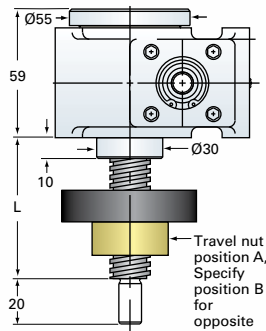

Max Allowable Input (kW)	No Load Torque (N-m)	Torque to Raise 1 kN (N-m)	Max worm speed at Rated Load (rpm)	Max Load at 1,425 rpm (kN)
0.27	0.11	0.45	1,130	4.0
0.13	0.11	0.19	1,300	4.6

EM05-MSJ Travel Nut and Flange

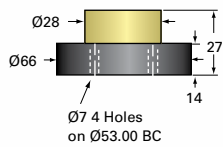

EM05-MSJ Options

Top Plate (optional): 9000-EM-12

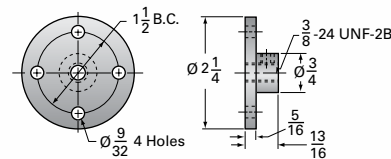

Clevis End (optional): 9001-EM-12

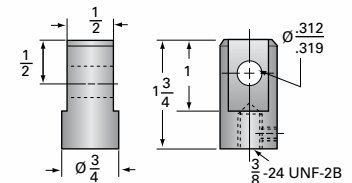

Motor Mounts
see pg 180-181

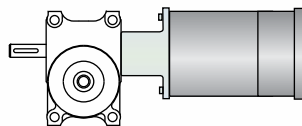

Limit Switch
see pg 196-201

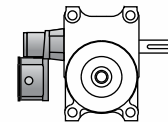

EM1-MSJ

EM1-MSJ TOP VIEW

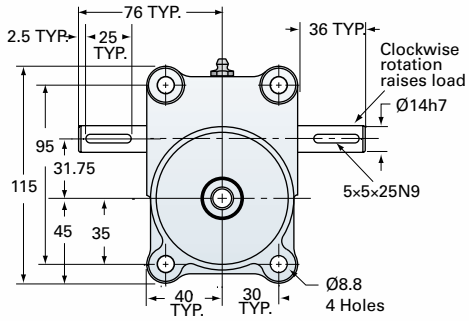

EM1-MSJ-U UPRIGHT

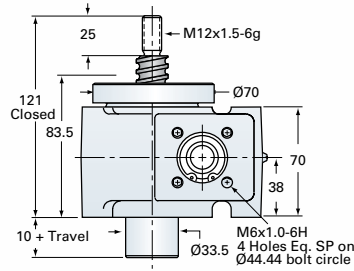

EM1-MSJ-I INVERTED

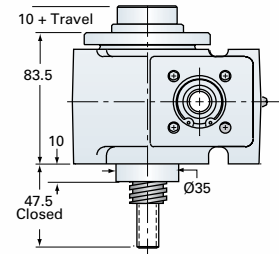

MODEL	Gear Ratio	Capacity (kN)	Raise for One Turn of Worm (mm)	Max Input Torque (N-m)
EM1-MSJ	5:1	10	0.80	5.19
	20:1	10	0.20	2.44

Screw Specs:
 Screw: Tr20x4
 Root diameter (mm): 14.9
 Start torque = 2 × Running Torque
 Approximate weight (Kg)
 "0" Travel: 2.5
 Per 100mm travel: 0.19
 Grease: 0.23

Lifting screw must be secured to prevent rotation for non-keyed units.
 Caution: Jack may be self-lowering in some operating conditions.

EM1-MSJ-UR UPRIGHT ROTATING

For ordering, specify "L" dimension
L(min) = travel + 140

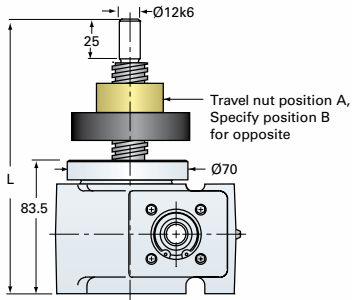

EM1-MSJ-IR INVERTED ROTATING

For ordering, specify "L" dimension
L(min) = travel + 90

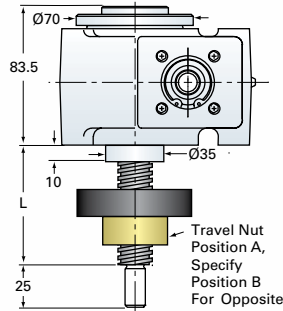

Max Allowable
Input (kW)

No Load
Torque (N-m)

Torque to
Raise 1 kN (N-m)

Max worm speed
at Rated Load (rpm)

Max Load at
1,425 rpm (kN)

0.36

0.34

0.52

665

4.7

0.19

0.34

0.24

730

5.1

EM1-MSJ Travel Nut and Flange

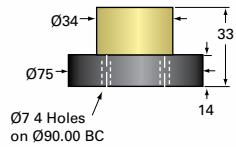

EM1-MSJ Options

Top Plate (optional): 9000-EM-11

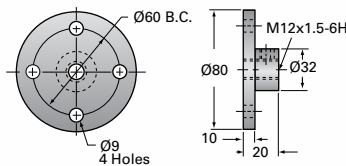

Clevis End (optional): 9001-EM-11

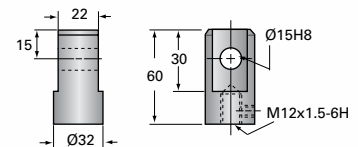

Motor Mounts
see pg 180-181

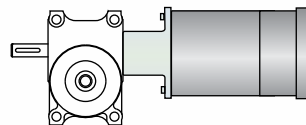

Limit Switch
see pg 196-201

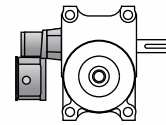

EM2.5-MSJ

EM2.5-MSJ TOP VIEW

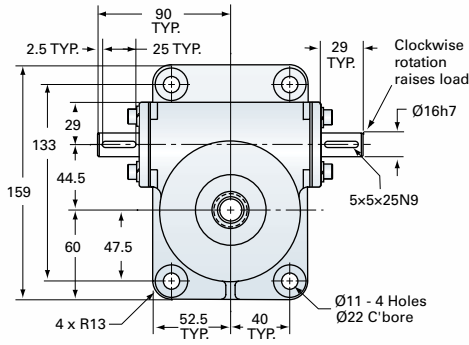

EM2.5-MSJ-U UPRIGHT

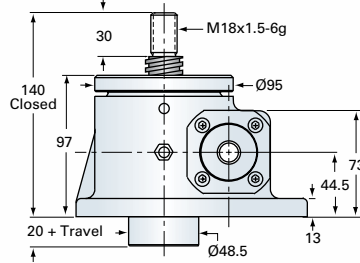

EM2.5-MSJ-I INVERTED

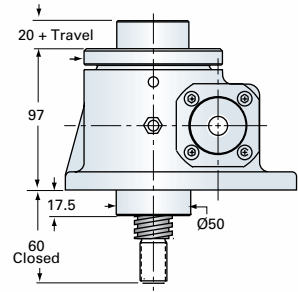

MODEL	Gear Ratio	Capacity (kN)	Raise for One Turn of Worm (mm)	Max Input Torque (N-m)
EM2.5-MSJ	6:1	25	1.0	14.9
	24:1	25	0.25	6.3

Screw Specs:
 Screw: Tr26x6
 Root diameter (mm): 17.8
 Start torque = 2 × Running Torque
 Approximate weight (Kg)
 "0" Travel: 7.7
 Per 100mm travel: 0.32
 Grease: 0.22

Lifting screw must be secured to prevent rotation for non-keyed units.
 Caution: Jack may be self-lowering in some operating conditions.

EM2.5-MSJ-UR UPRIGHT ROTATING

For ordering, specify "L" dimension
L(min) = travel + 168

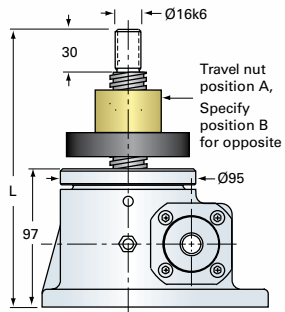

EM2.5-MSJ-IR INVERTED ROTATING

For ordering, specify "L" dimension
L(min) = travel + 92

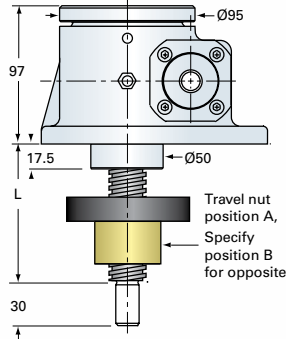

Max Allowable Input (kW)	No Load Torque (N-m)	Torque to Raise 1 kN (N-m)	Max worm speed at Rated Load (rpm)	Max Load at 1,425 rpm (kN)
1.51	0.56	0.59	975	17.0
0.38	0.56	0.25	575	10.1

EM2.5-MSJ Travel Nut and Flange

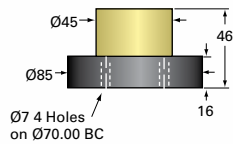

EM2.5-MSJ Options

Top Plate (optional): 9000-EM-01

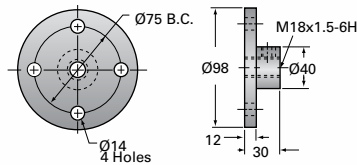

Clevis End (optional): 9001-EM-01

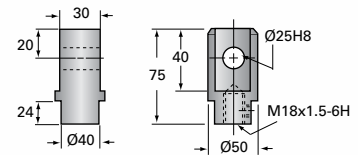

Motor Mounts
see pg 180-181

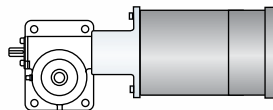

Limit Switch
see pg 196-201

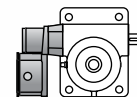

EM5-MSJ

EM5-MSJ TOP VIEW

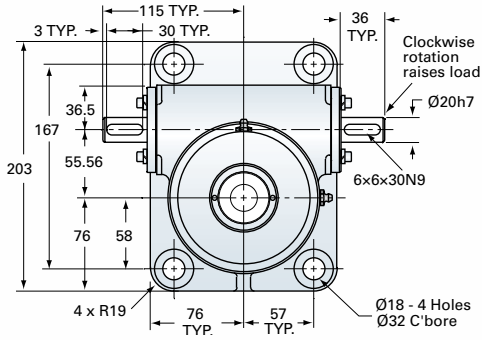

EM5-MSJ-U UPRIGHT

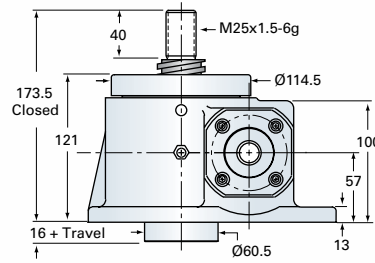

EM5-MSJ-I INVERTED

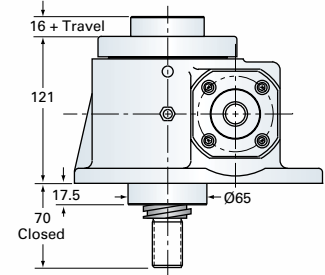

MODEL	Gear Ratio	Capacity (kN)	Raise for One Turn of Worm (mm)	Max Input Torque (N-m)
EM5-MSJ	6:1	50	1.17	40.3
	24:1	50	0.29	16.0

Screw Specs:
 Screw: Tr40x7
 Root diameter (mm): 30.9
 Start torque = 2 x Running Torque
 Approximate weight (Kg)
 "0" Travel: 13.6
 Per 100mm travel: 0.81
 Grease: 0.45

Lifting screw must be secured to prevent rotation for non-keyed units.
 Caution: Jack may be self-lowering in some operating conditions.

EM5-MSJ-UR UPRIGHT ROTATING

For ordering, specify "L" dimension
L(min) = travel + 207

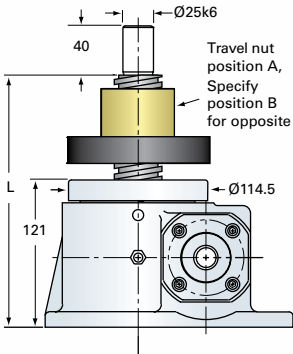

EM5-MSJ-IR INVERTED ROTATING

For ordering, specify "L" dimension
L(min) = travel + 103

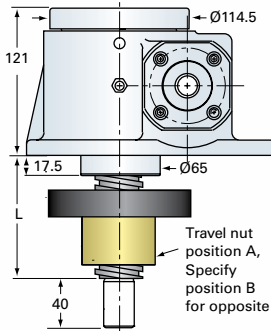

Max Allowable
Input (kW)

No Load
Torque (N-m)

Torque to
Raise 1 kN (N-m)

Max worm speed
at Rated Load (rpm)

Max Load at
1,425 rpm (kN)

1.87

1.13

0.81

445

15.6

0.51

1.13

0.32

300

10.7

EM5-MSJ Travel Nut and Flange

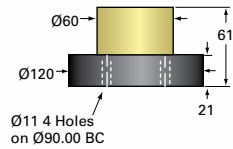

EM5-MSJ Options

Top Plate (optional): 9000-EM-02

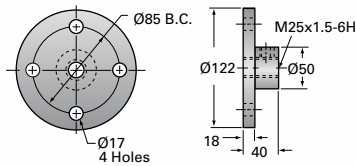

Clevis End (optional): 9001-EM-02

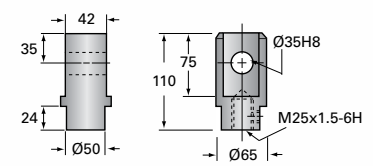

Motor Mounts
see pg 180-181

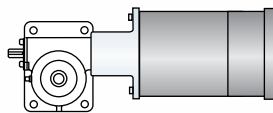

Limit Switch
see pg 196-201

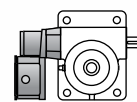

EM10-MSJ

EM10-MSJ TOP VIEW

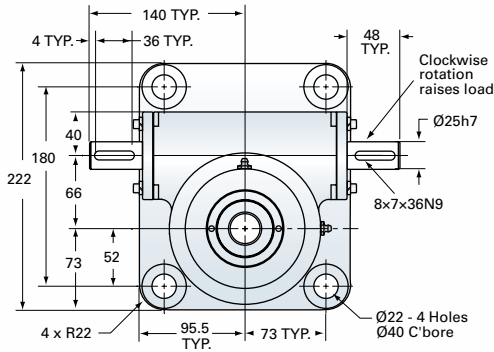

EM10-MSJ-U UPRIGHT

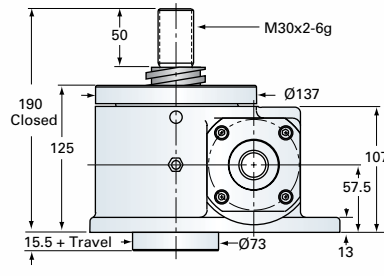

EM10-MSJ-I INVERTED

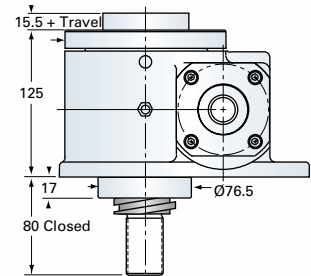

MODEL	Gear Ratio	Capacity (kN)	Raise for One Turn of Worm (mm)	Max Input Torque (N-m)
EM10-MSJ	8:1	100	1.50	97.2
	24:1	100	0.50	50.0

Screw Specs:
 Screw: Tr55x12
 Root diameter (mm): 40
 Start torque = 2 x Running Torque
 Approximate weight (Kg)
 "0" Travel: 20.4
 Per 100mm travel: 1.46
 Grease: 0.68

Lifting screw must be secured to prevent rotation for non-keyed units.
 Caution: Jack may be self-lowering in some operating conditions.

EM10-MSJ-UR UPRIGHT ROTATING

For ordering, specify "L" dimension
L(min) = travel + 227

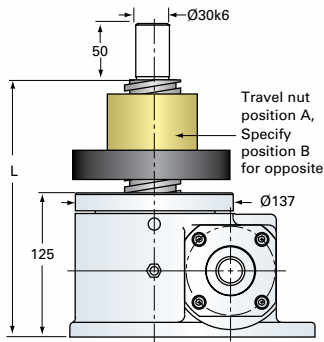

EM10-MSJ-IR INVERTED ROTATING

For ordering, specify "L" dimension
L(min) = travel + 120

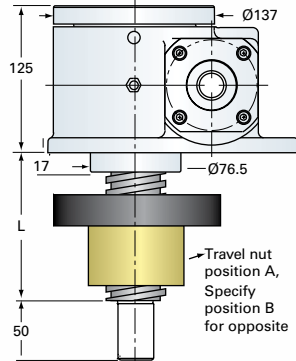

Max Allowable Input (kW)	No Load Torque (N-m)	Torque to Raise 1 kN (N-m)	Max worm speed at Rated Load (rpm)	Max Load at 1,425 rpm (kN)
3.65	2.26	0.97	360	25.2
1.10	2.26	0.50	210	14.8

EM10-MSJ Travel Nut and Flange

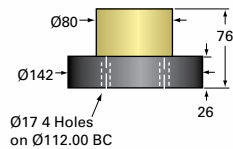

EM10-MSJ Options

Top Plate (optional): 9000-EM-04

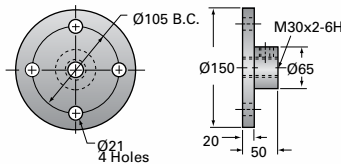

Clevis End (optional): 9001-EM-04

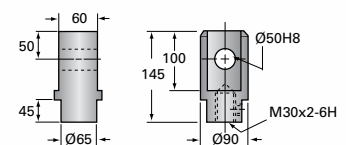

Motor Mounts
see pg 180-181

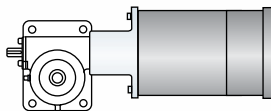

Limit Switch
see pg 196-201

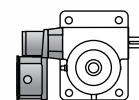

EM20-MSJ

EM20-MSJ TOP VIEW

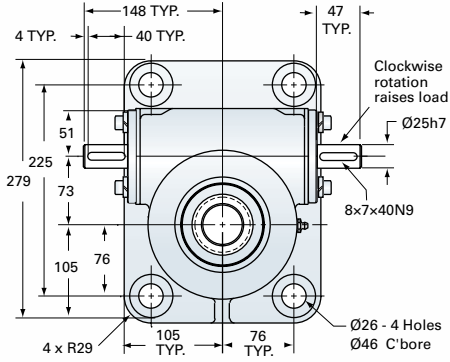

EM20-MSJ-U UPRIGHT

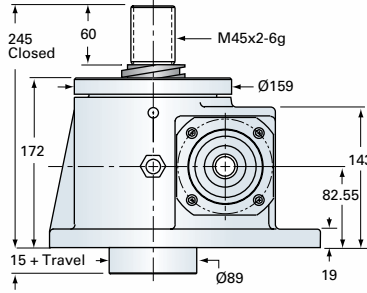

EM20-MSJ-I INVERTED

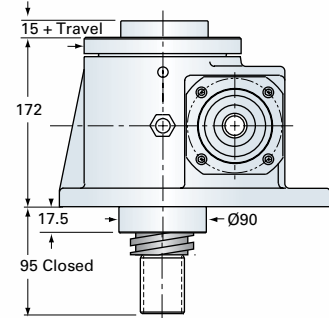

MODEL	Gear Ratio	Capacity (kN)	Raise for One Turn of Worm (mm)	Max Input Torque (N-m)
EM20-MSJ	8:1	200	1.50	215
	24:1	200	0.50	108

Screw Specs:
Screw: Tr65x12
Root diameter (mm): 50
Start torque = 2 × Running Torque
Approximate weight (Kg)
"0" Travel: 36.3
Per 100mm travel: 2.12
Grease: 1.0

Lifting screw must be secured to prevent rotation for non-keyed units.
Caution: Jack may be self-lowering in some operating conditions.

EM20-MSJ-UR UPRIGHT ROTATING

For ordering, specify "L" dimension
 L(min) = travel + 285

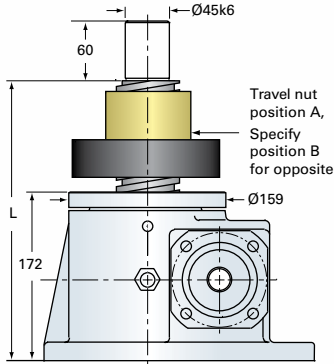

EM20-MSJ-IR INVERTED ROTATING

For ordering, specify "L" dimension
 L(min) = travel + 135

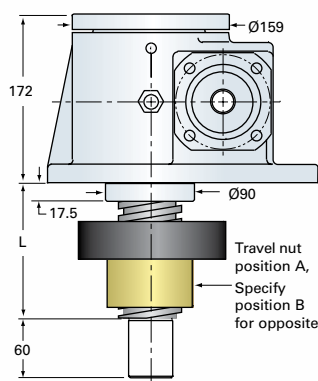

Max Allowable
 Input (kW)

No Load
 Torque (N-m)

Torque to
 Raise 1 kN (N-m)

Max worm speed
 at Rated Load (rpm)

Max Load at
 1,425 rpm (kN)

5.60

4.52

1.08

250

35.0

1.90

4.52

0.54

165

23.0

EM20-MSJ Travel Nut and Flange

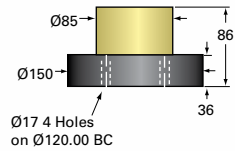

EM20-MSJ Options

Top Plate (optional): 9000-EM-06

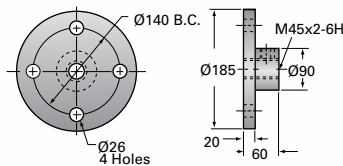

Clevis End (optional): 9001-EM-06

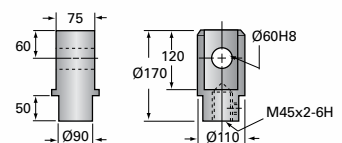

Motor Mounts
 see pg 180-181

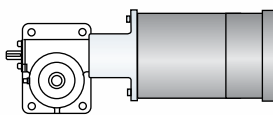

Limit Switch
 see pg 196-201

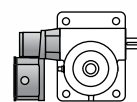

CUBIC JACKS

MACHINE AND BALL SCREW

ActionJac™ Cubic Ball Screw and Machine Screw Jacks meet international Cubic Jack versatile mounting standards. Mounting versatility is further increased with the provision for trunnion mounting integral to the Cubic Jack housing. Housings are made from high quality corrosion-resistant aluminum. Cubic Jacks are capable of directly mounting a wide array of motors and gear reducers. Available in true metric and inch standards.

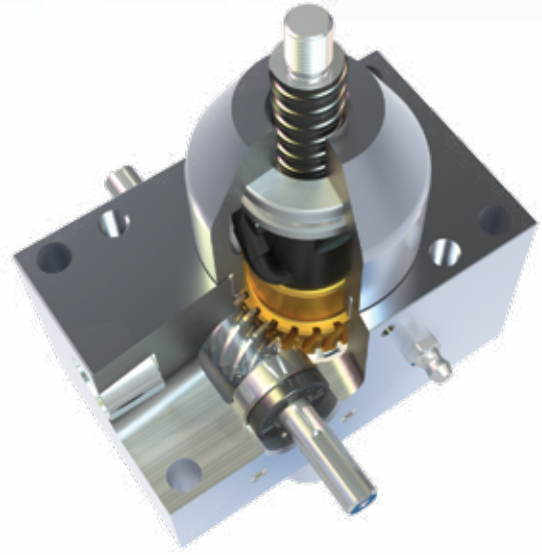

Nook/Thomson worm gear screw jacks are used widely in the solar industry.



CUBIC JACKS 154-161

..... Quick Reference
156-157
..... Column Strength
158-159
..... Life Expectancy
160
..... Reference Number System
161

CUBIC JACKS TECHNICAL DATA 162-177

..... 0.5C-BSJ / 0.5CHL-BSJ
162-163
..... 1C-BSJ / 1CHL-BSJ
164-165
..... Mini Cubic Jacks
166-167
..... 1C-MSJ
168-169
..... EM05C-BSJ
170-171
..... EM1C-BSJ
172-173
..... EM05C-MSJ
174-175
..... EM1C-MSJ
176-177

QUICK REFERENCE

INCH CUBIC JACKS

MODEL	Gear Ratio	Capacity (tons)	Lifting Screw Dia (in)	Screw Lead (in)	Root Dia (in)	Turns of Worm for 1" travel	Max input Torque (in.-lb.)	Max Input (hp)	Max Worm Speed at Rated Load (rpm)	Max Load at 1,750 rpm (lb)	Torque to Raise 1 lb. (in.-lb)	Tare Drag Torque (in.-lb)	Back Drive Holding Torque
0.5C-BSJ	5:1	½	⅝	.200	.500	25	9.5	⅓	1,800	1,000	.0095	1	1.0
	20:1	½	⅝	.200	.500	100	4.0	⅙	1,800	1,000	.0040	1	.25
0.5CHL-BSJ	5:1	½	⅝	.500	.500	10	24.2	⅓	868	496	.0242	1	2
	20:1	½	⅝	.500	.500	40	10.2	⅙	1,030	588	.0102	1	1
1C-BSJ	5:1	1	¾	.200	.602	25	19	½	1,660	1,895	.0095	3	1.5
	20:1	1	¾	.200	.602	100	9	¼	1,750	2,000	.0045	3	.50
1CHL-BSJ	5:1	1	¾	.500	.602	10	48.2	½	654	747	.0241	3	3.5
	20:1	1	¾	.500	.602	40	9	¼	691	790	.0114	3	1.5
MJC-20	5:1	.5	½	.250	.332	20	19	⅓	1,090	631	.019	—	—
MJC-25	5:1	.5	⅝	.200	.377	25	21	⅓	1,040	571	.021	—	—
MJC-40	5:1	.5	⅝	.125	.457	40	17	⅓	1,260	706	.017	—	—
MJC-50	5:1	.5	½	.100	.359	50	14	⅓	1,560	857	.014	—	—
MJC-80	20:1	.5	½	.250	.332	80	8	⅙	1,310	750	.008	—	—
MJC-100	20:1	.5	⅝	.200	.377	100	9	⅙	1,210	667	.009	—	—
MJC-160	20:1	.5	⅝	.125	.457	160	7	⅙	1,500	857	.007	—	—
MJC-200	20:1	.5	½	.100	.359	200	6	⅙	1,800	1,000	.006	—	—
1C-MSJ	5:1	1	¾	.200	.502	25	45	½	700	800	.0225	3	—
	20:1	1	¾	.200	.502	100	21	¼	750	857	.0105	3	—

NOTES:

- 1) The recommended maximum speed is 1,800 rpm provided that the recommended horsepower and temperature are not exceeded.
- 2) Input torque is shown as torque to lift one pound of load. Starting torque is 100% greater than torque shown for Machine Screw Jacks and 50% greater than torque shown for Ball Screw Jacks. Tare drag torque should be added for all loads.
- 3) Maximum allowable horsepower ratings are based on a 25% duty cycle at standard ambient temperature, with 1 minute on 2 minute off cycles. For operation at higher duty cycles or repeated use over any segment of the total travel, temperature must be monitored and remain less than 200°F.
- 4) Overload capacity of the Cubic Jack is as follows: 10% for dynamic loads, 30% for static loads.
- 5) Cubic Machine Screw Jacks having gear ratios of 20:1 are self-locking and will hold loads without backdriving in the absence of vibration. All other ratios may require a brake to prevent backdriving.

6) All units are suitable for intermittent operation providing that the housing temperature including ambient is not lower than -20°F or higher than +200°F. Factory supplied grease in standard units will operate in this range. For higher or lower operating temperature ranges consult Nook/Thomson.

- 7) Accessories such as boots, top plates and clevises are available.
- 8) Catalog dimensions are representative only and are subject to change without notice. For construction, use only certified prints.
- 9) Units are not to be used as personnel support or movement.
- 10) End-of-travel stops are not provided.
- 11) Tare drag torque need only be added if operating under 25% rated load.

$$\text{Horsepower per jack} = \frac{\text{Torque to raise one pound} \times \text{Number of pounds to be raised} \times \text{rpm}}{63,025}$$

12) Measurements are for non-keyed units. See individual jack pages for keyed jack info.

QUICK REFERENCE

METRIC CUBIC JACKS

MODEL	Gear Ratio	Capacity (kN)	Lifting Screw Dia (mm)	Screw lead (mm)	Root Dia (mm)	Raise for One Turn of Worm (mm)	Max Input Torque (N-m)	Max Input (kW)	Max Worm Speed at Rated Load (rpm)	Max Load at 1,425 rpm (kN)	Torque to Raise 1 kN (N-m)	No Load Torque (N-m)	Back Drive Holding Torque
EM05C-BSJ	5:1	5	15.7	5	12.9	1.00	1.21	0.21	1,625	5.0	0.24	0.11	1.0
	20:1	5	15.7	5	12.9	0.25	0.51	0.09	1,625	5.0	0.10	0.11	0.5
EM1C-BSJ	5:1	10	20	5	17.5	1.00	2.41	0.38	1,500	10.0	0.24	0.34	2.0
	20:1	10	20	5	17.5	0.25	1.14	0.19	1,585	10.0	0.11	0.34	1.0
EM05C-MSJ	5:1	5	16	4	10.9	0.80	2.25	0.27	1,130	4.0	0.45	0.11	—
	20:1	5	16	4	10.9	0.20	0.94	0.13	1,130	4.6	0.19	0.11	—
EM1C-MSJ	5:1	10	20.0	5	17.5	0.80	5.19	0.36	665	4.7	0.52	0.34	—
	20:1	10	20.0	5	17.5	0.20	2.44	0.19	730	5.1	0.24	0.34	—

NOTES:

- 1) The recommended maximum speed is 1,800 rpm providing the recommended horsepower and temperature are not exceeded.
- 2) Input torque is shown as torque to lift one kN of load. Starting torque is 100% greater than torque shown for Machine Screw Jacks and 50% greater than the torque shown for Ball Screw Jacks. For loads less than 25% of rated loads, add tare drag torque.
- 3) Maximum allowable power ratings are based on a 25% duty cycle. For operation at higher duty cycles or repeated use over any segment of the total travel, temperature must be monitored and remain less than 95°C.
- 4) Overload capacity of the Cubic Jack is as follows: 10% for dynamic loads, 30% for static loads.
- 5) Cubic Machine Screw Jacks having gear ratios of 20:1 are self-locking and will hold loads without backdriving in the absence of vibrations. All other ratios may require a brake to prevent backdriving.
- 6) All units are suitable for intermittent operation providing that the housing temperature including ambient is not lower than -30°C. or higher than +95°C. Factory supplied grease in standard units will

operate in this range. For higher or lower operating temperature ranges consult Nook/Thomson.

- 7) Accessories such as boots, limit switches, top plates and clevises are available.
- 8) Catalog dimensions are representative only and are subject to change without notice. For construction, use only certified prints.
- 9) Units are not to be used as personnel support or movement.
- 10) End-of-travel stops are not provided.

$$\text{kW per jack} = \frac{\left(\left(\begin{array}{l} \text{Torque to} \\ \text{raise one} \\ \text{kN(N} \cdot \text{m)} \end{array} \right) \times \begin{array}{l} \text{Number} \\ \text{of kN} \\ \text{to be raised} \end{array} \right) + \begin{array}{l} \text{Tare} \\ \text{Drag} \\ \text{Torque} \end{array} \right) \times \text{RPM}}{9,549}$$

- 11) Starting torque is 100% greater than torque shown.
- 12) No load torque need only be added if operating under 25% rated load.

COLUMN STRENGTH

CUBIC INCH MACHINE AND BALL SCREW JACKS

Column strength is the ability of the lift shaft to hold compressive loads without buckling. With longer screw lengths, column strength may be substantially lower than nominal jack capacity.

If the lift shaft is in tension only, the screw jack travel is limited by the available screw material or by the critical speed of the screw. Refer to the ball screw technical section for critical speed limitations. If there is any possibility for the lift shaft to go into compression, the application should be sized for sufficient column strength.

The chart below is used to determine the required jack size in applications where the lift shaft is loaded in compression.

TO USE THESE CHARTS:

Find a point at which the maximum length “L” intersects the maximum load. Be sure the jack selected is above and to the right of that point.

CAUTION: chart does not include a design factor.

The chart assumes proper jack alignment with no bending loads on the screw. Effects from side loading are not included in this chart. Jacks operating horizontally with long lift shafts can experience bending from the weight of the screw.

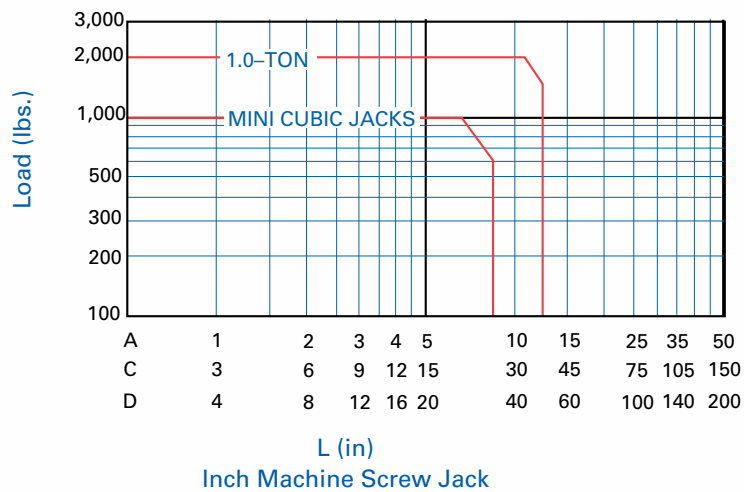
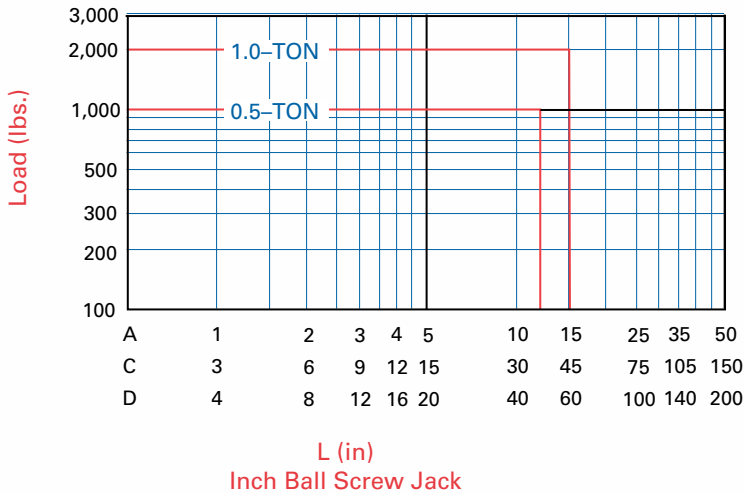

MOUNTING CONDITIONS

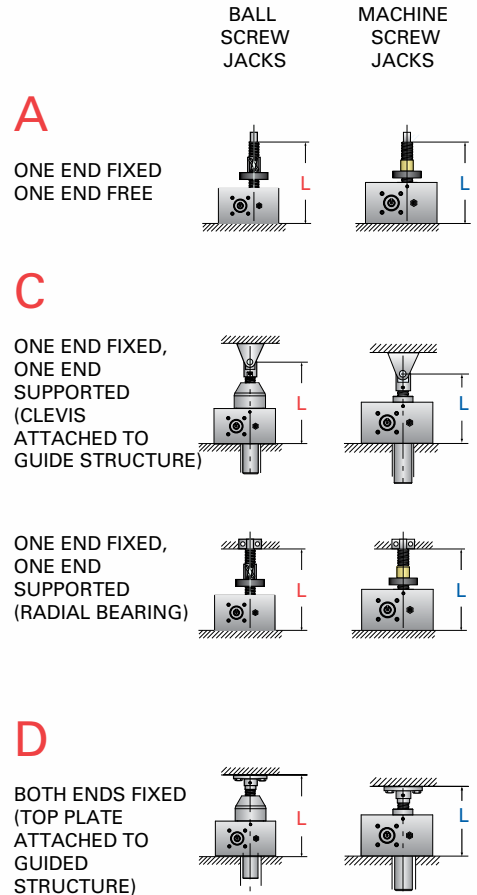

COLUMN STRENGTH

CUBIC METRIC MACHINE AND BALL SCREW JACKS

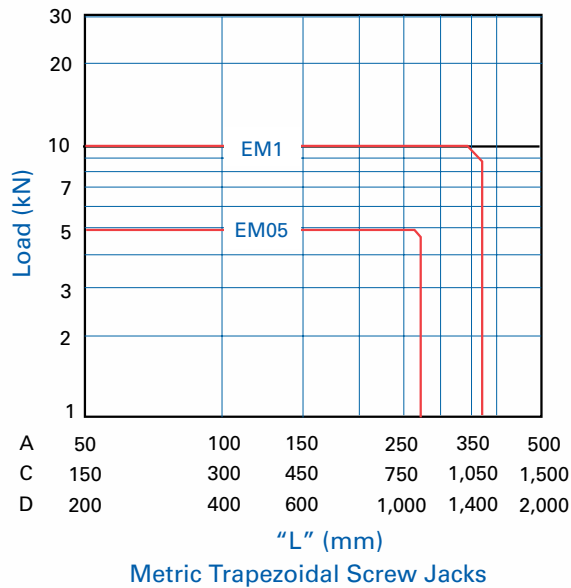
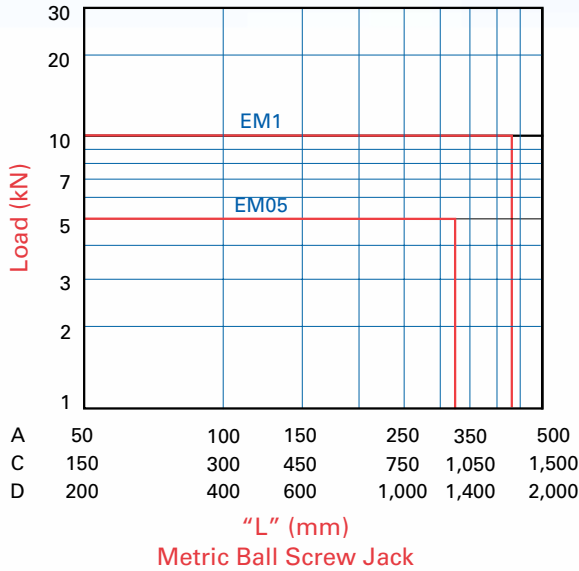

MOUNTING CONDITIONS

BALL SCREW JACKS MACHINE SCREW JACKS

A

ONE END FIXED
ONE END FREE

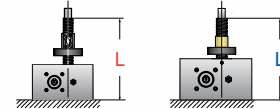

C

ONE END FIXED,
ONE END SUPPORTED
(CLEVIS ATTACHED TO GUIDE STRUCTURE)

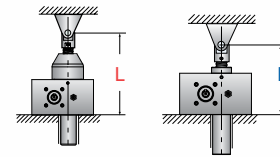

ONE END FIXED,
ONE END SUPPORTED
(RADIAL BEARING)

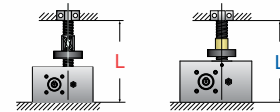

D

BOTH ENDS FIXED
(TOP PLATE ATTACHED TO GUIDED STRUCTURE)

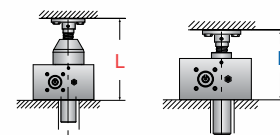

AVAILABLE LIFT SCREW LENGTHS

As a major manufacturer of industrial lead screws, Nook/Thomson stocks a wide selection of screws. Nook/Thomson has the capacity to make long screws for special applications. Rotating screw jacks can be built with a larger diameter lift screw for greater column strength, or a different lead to change the jack operating speed.



LIFE EXPECTANCY

INCH BALL SCREW CUBIC JACKS

MODEL	OPERATING LOAD (lbs)	MINIMUM INCHES OF TRAVEL (in. x 103)			
		UPRIGHT & INVERTED		UPRIGHT & INVERTED ROTATING	
		Standard (in)	High-lead (in)	Standard (in)	High-lead (in)
	1,000	377	708	471	885
0.5C-BSJ	750	893	1,678	116	2,097
0.5HLC-BSJ	500	3,014	5,662	3,767	7,078
	250	24,111	45,299	56,623	56,623
	2,000	133	2,019	166	2,524
1C-BSJ	1,500	316	4,785.9	394	5,982
1HLC-BSJ	1,000	1,065	16,152	1,331	20,190
	500	8,518	129,218	10,648	161,523

NOTES:

- Refer to Lubrication Instructions in order to obtain maximum life from ball screw assemblies.
- These values may be greatly reduced if the units are subjected to misalignment, shock loads, side thrust, contamination or lack of proper lubrication and maintenance

LIFE EXPECTANCY

METRIC BALL SCREW CUBIC JACKS

MODEL	OPERATING LOAD (kN)	MINIMUM METERS OF TRAVEL	
		UPRIGHT & INVERTED	UPRIGHT ROTATING
		Standard	Standard
EM05C-BSJ	4	34,295	42,869
	2	274,360	342,950
	1	2,194,880	2,743,600
EM1C-BSJ	8	21,455	26,819
	5	87,880	109,850
	2.5	703,040	878,800

NOTES:

- Refer to Lubrication Instructions in order to obtain maximum life from ball screw assemblies
- These values may be greatly reduced if the units are subjected to misalignment, shock loads, side thrust, contamination or lack of proper lubrication and maintenance.

REFERENCE NUMBER SYSTEM

CUBIC JACKS

1C-MSJ- U 6:1 / SSE-1 / SSE-2 / FT / 24.5 / BS

CUBIC JACK MODEL

MACHINE SCREW	BALL SCREW	METRIC BALL SCREW
Model #	Model #	Model #
MJC-20	0.5C-BSJ	EM05C-BSJ
MJC-25	0.5CHL-BSJ	EM1C-BSJ
MJC-40	1C-BSJ	
MJC-50	1CHL-BSJ	
MJC-80		TRAPEZOIDAL SCREW
MJC-100		Model #
MJC-160		EM05C-BSJ
MJC-200		EM1C-BSJ
1C-MSJ		

CONFIGURATION

U = Upright
 I = Inverted
 UR = Upright Rotating
 UK = Upright Keyed
 IK = Inverted Keyed

GEAR RATIO

Refer to product pages for available ratios.

SHAFT ORDER CODE

SSE - 1

CCW Position 1, 3, 5 & 7
 CW Position 2, 4, 6 & 8

ORDER CODES (Must Include A Position)

NOTE: Both Shaft Extensions Must Be Specified.

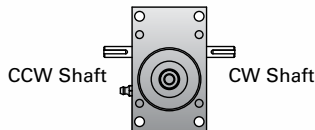

NO ACCESSORY

SSE- = Standard Shaft Extension, Position 1 or 2
 000- = Delete Shaft Extension, Position 1 or 2
 SPC- = Special Modified Shaft Extension, Position 1 or 2

Motor Mounts

NEMA Frames 23, 34, and 48 are available.
 Contact Nook Engineering for further information.

Hand Wheel

See page 185 for available Hand Wheels.

Counters

See page 199 for available Counters.

HOUSING CONFIGURATION

F = Standard Flange Base

SCREW CONFIGURATION

TRANSLATING - U and I MODELS

T = Standard Threaded End
 C = Clevis End
 P = Top Plate

ROTATING - UR and IR MODELS

A = Travel Nut Position "A"
 B = Travel Nut Position "B"

UR - Upright Rotating

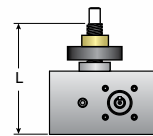

Travel Nuts shown in position "A"

TRAVEL

For Translating Screw Models (U and I) use actual Travel in inches. For Rotating Screw Models (UR) use "L" Dimension in Inches

MODIFIER LIST

E and/or B Optional
 E = In-Line Encoder (Motor or motor mount is required.)
 B = Bellows Boots (See page 204-205. Must calculate extend and retract length.)

S or M Required
 S = Standard, no additional description required
 M = Modified, additional description required

0.5C-BSJ 0.5CHL-BSJ

0.5C-BSJ & 0.5CHL-BSJ TOP VIEW

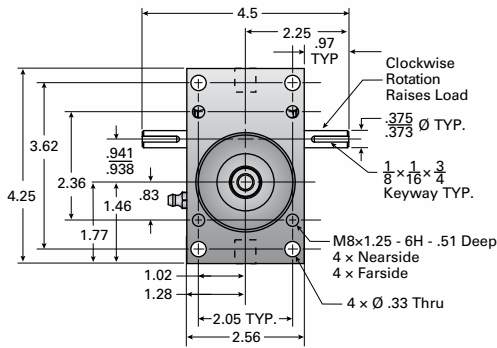

0.5C-BSJ-U & 0.5CHL-BSJ-U UPRIGHT

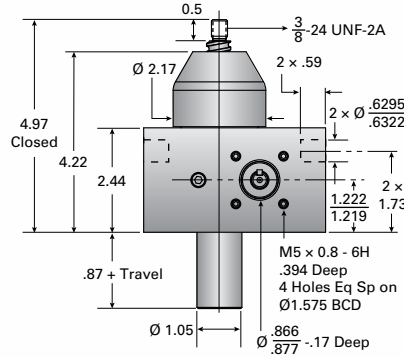

0.5C-BSJ-I & 0.5CHL-BSJ-I INVERTED

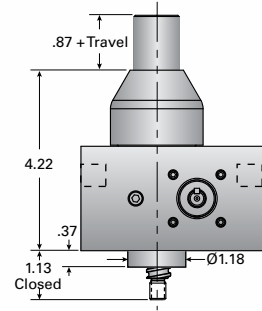

MODEL	Gear Ratio	Turns of Worm for 1" Travel	Max Input Torque (in-lb)	Max Allowable Input (hp)	Tare Drag Torque (in-lb)	Backdrive holding torque (ft-lb)
0.5-BSJ Capacity: 0.5 tons Screw: 0631-0200	5:1	25	9.5	1/3	1	1.0
	20:1	100	4.0	1/6	1	.25
0.5HL-BSJ Capacity: 0.5 tons Screw: 0631-0500	5:1	10	24.2	1/3	1	2
	20:1	40	10.2	1/6	1	1

Screw Specs:
 Root diameter (in): 0.500
 Start torque = 1.5 x Running Torque
 Approximate weight (lbs)
 "0" Travel: 3.5
 Per inch travel: 0.3
 Grease: 0.3

Caution: Jack is self-lowering. Lifting screw must be secured to prevent rotation for non-keyed units.

0.5C-BSJ-UR & 0.5CHL-BSJ-UR
UPRIGHT or INVERTED ROTATING

FOR ORDERING: Specify "L"
 dimension L (min) = Travel + 5.08

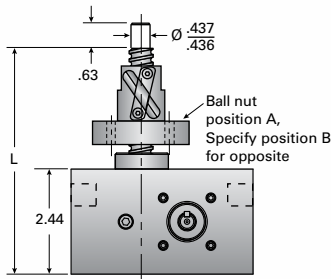

0.5C-BSJ-UK & 0.5CHL-BSJ-UK
UPRIGHT KEYED

0.5C-BSJ-UK & 0.5CHL-BSJ-UK
INVERTED KEYED

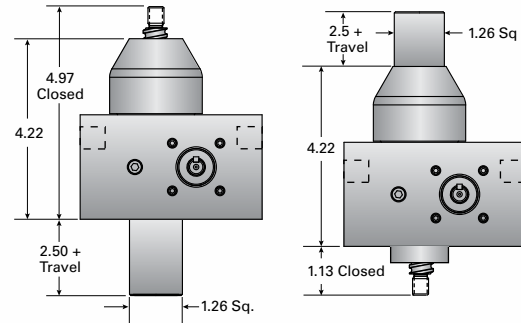

	NON-KEYED			KEYED		
	Torque to raise 1 lb (in-lb)	Max Worm Speed at Rated Load (rpm)	Max Load at 1,750 rpm (lb)	Torque to raise 1 lb (in-lb)	Max Worm Speed at Rated Load (rpm)	Max Load at 1,750 rpm (lb)
	.0095	1,800	1,000	.0105	1,800	1,000
	.0040	1,800	1,000	.0044	1,080	1,000
	.0242	868	496	.0266	790	450
	.0102	1,030	588	.0112	936	534

0.5C-BSJ Ball Nut and Flange

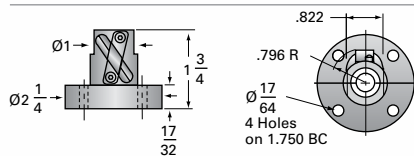

0.5CHL-BSJ Ball Nut and Flange

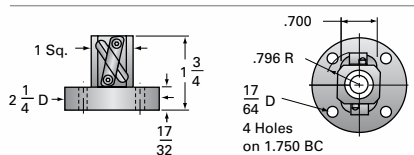

0.5C-BSJ & 0.5CHL-BSJ Options (Standard Steel Parts)

Top Plate (optional): 9000-00-12

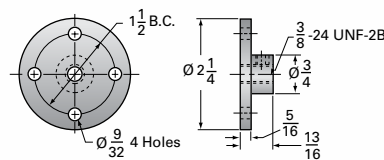

Clevis End (optional): 9001-00-12

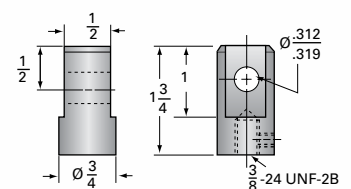

Motor Mounts

see pg 180-181

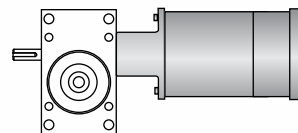

1C-BSJ 1CHL-BSJ

1C-BSJ & 1CHL-BSJ TOP VIEW

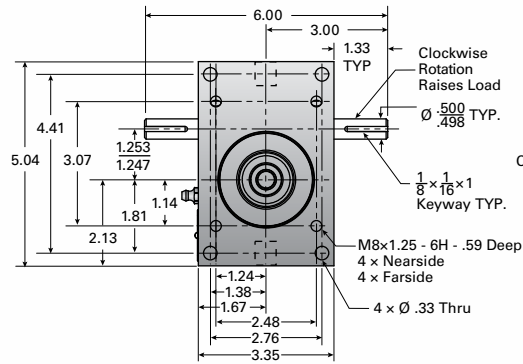

1C-BSJ-U & 1CHL-BSJ-U UPRIGHT

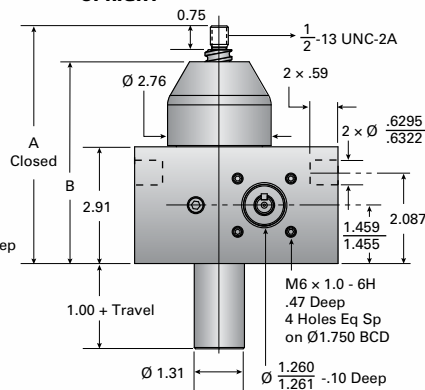

1C-BSJ-I & 1CHL-BSJ-I INVERTED

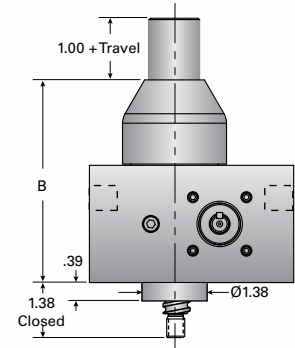

MODEL	Gear Ratio	Turns of Worm for 1" Travel	Max Input Torque (in-lb)	Max Allowable Input (hp)	Tare Drag Torque (in-lb)	Backdrive holding torque (ft-lb)	A (in)	B (in)
1C-BSJ Capacity: 1 ton Screw: 0750-0200	5:1	25	19	1/2	3	1.5	5.57	4.57
	20:1	100	9	1/4	3	.5	5.57	4.57
1CHL-BSJ Capacity: 1 ton Screw: 0750-0500	5:1	10	48.2	1/2	3	3.5	6.62	5.62
	20:1	40	9	1/4	3	1.5	6.62	5.62

Screw Specs:
 Root diameter (in): 0.602
 Start torque = 1.5 x Running Torque
 Approximate weight (lbs)
 "0" Travel: 7.2
 Per inch travel: 0.04
 Grease: 0.5

Caution: Jack is self-lowering. Lifting screw must be secured to prevent rotation for non-keyed units.

**1C-BSJ-UR & 1CHL-BSJ-UR
UPRIGHT & INVERTED ROTATING**

FOR ORDERING: Specify "L"
dimension L (min) = Travel + 5.69

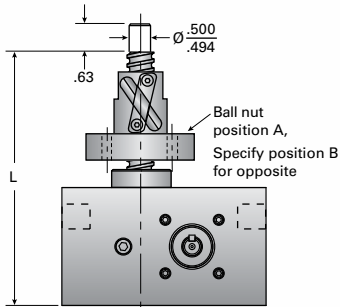

**1C-BSJ-UK & 1CHL-BSJ-UK
UPRIGHT KEYED**

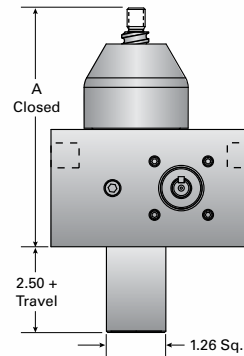

**1C-BSJ-UK & 1CHL-BSJ-UK
INVERTED KEYED**

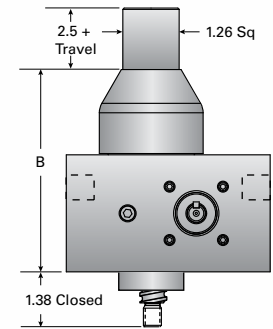

	NON-KEYED			KEYED		
	Torque to raise 1 lb (in-lb)	Max Worm Speed at Rated Load (rpm)	Max Load at 1,750 rpm (lb)	Torque to raise 1 lb (in-lb)	Max Worm Speed at Rated Load (rpm)	Max Load at 1,750 rpm (lb)
	.0095	1,660	1,895	.0104	1,515	1,731
	.0045	1,750	2,000	.0049	1,608	1,837
	.0241	654	747	.0265	595	680
	.0114	691	790	.0125	628	718

1C-BSJ Ball Nut and Flange

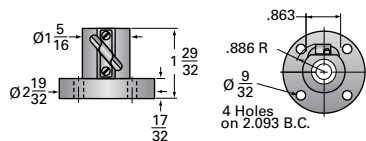

1CHL-BSJ Ball Nut and Flange

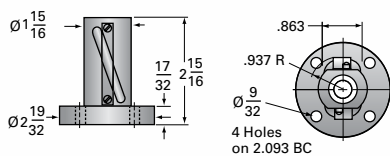

1C-BSJ & 1CHL Options (Standard Steel Parts)

Top Plate (optional): 9000-00-11

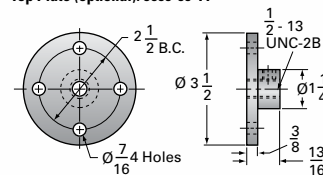

Clevis End (optional): 9001-00-11

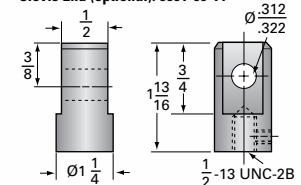

Motor Mounts
see pg 180-181

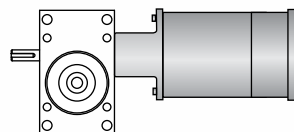

CUBIC JACKS

MINI CUBIC JACKS

MJC-xx TOP VIEW

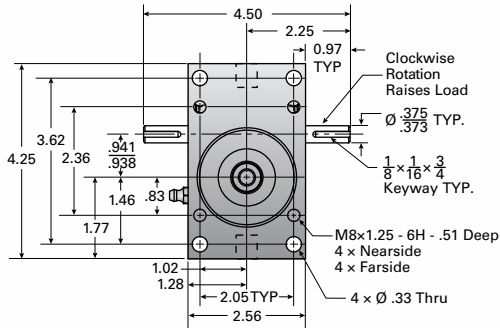

MJC-xx-U UPRIGHT & INVERTED

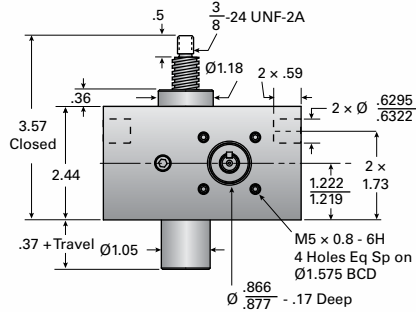

MODEL	Gear Ratio	Turns of Worm for 1" Travel	Torque at 1,000 lb. Load (in-lb)	Max Allowable Input (hp)	Screw size
MJC-20	5:1	20	19.3	1/3	1/2-4
MJC-25	5:1	25	20.7	1/3	5/8-5
MJC-40	5:1	40	16.7	1/3	5/8-8
MJC-50	5:1	50	13.5	1/3	1/2-10
MJC-80	20:1	80	8.0	1/6	1/2-4
MJC-100	20:1	100	8.7	1/6	5/8-5
MJC-160	20:1	160	7.0	1/6	5/8-8
MJC-200	20:1	200	5.7	1/6	1/2-10

Mini Jack Standard:
Start torque = 2 x Running Torque
Approximate weight (lbs)
"0" Travel: 3.0
Per inch travel: 0.2
Grease: 0.5

MJABC-xx-U UPRIGHT ANTI-BACKLASH

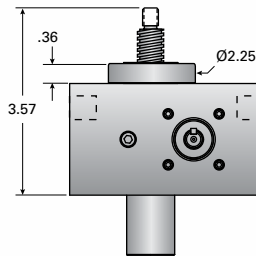

MJABC-xx-I INVERTED ANTI-BACKLASH

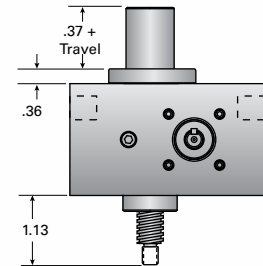

Lifting screw must be secured to prevent rotation for non-keyed units.
Caution: Jack may be self-lowering in some operating conditions.

MJC-xx-UR UPRIGHT & INVERTED ROTATING

For ordering, specify "L" dimension
 $L(\text{min}) = \text{travel} + 4.11$

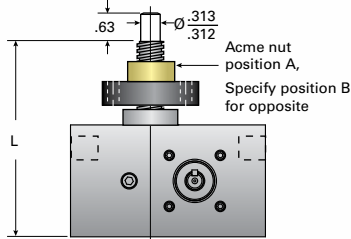

MJC-xx-UK UPRIGHT & INVERTED KEYED

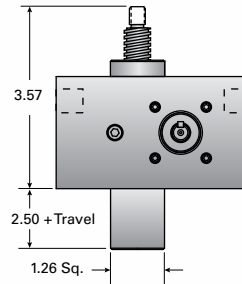

	RATING AT 1,750 RPM		COMPRESSION LOAD MAX TRAVEL		NON-KEYED		KEYED	
	Load (lb)	Lift Rate (in/min)	At 1,000 lbs. (in)	At Any Load (in)	Torque* (in-lb)	Max rpm at 1,000 Load	Torque* (in-lb)	Max rpm at Rated Load
	631	90.0	7.2	8.75	.019	1,090	.022	950
	571	72.0	8.3	9.38	.021	1,040	.024	900
	706	45.0	11.88	11.88	.017	1,260	.020	1,100
	857	36.0	8.3	9.38	.014	1,560	.016	1,350
	750	22.5	7.2	8.75	.008	1,310	.009	1,140
	667	18.0	8.3	9.38	.009	1,210	.010	1,050
	857	11.2	11.88	11.88	.007	1,500	.008	1,300
	1,000	9.0	8.3	9.38	.006	1,800	.007	1,560

* Torque to Raise 1 lb

MINI CUBIC JACK Nut and Flange

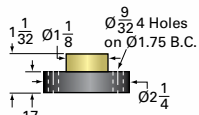

MINI CUBIC JACK Options (Standard Steel Parts)

Top Plate (optional): 9000-00-12

Clevis End (optional): 9001-00-12

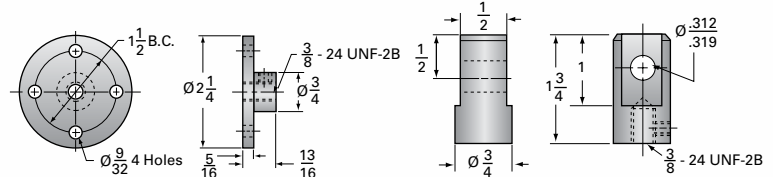

Motor Mounts
 see pg 180-181

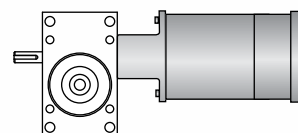

2D/3D CAD ONLINE

nookindustries.com

1C-MSJ

1C-MSJ TOP VIEW

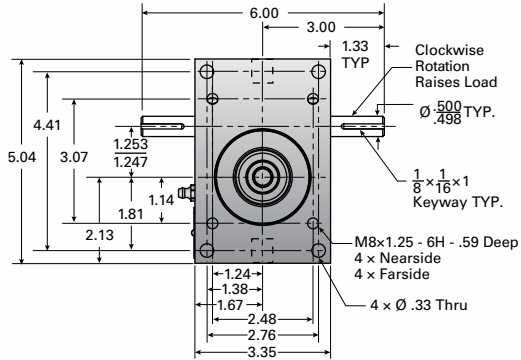

1C-MSJ-U UPRIGHT & INVERTED

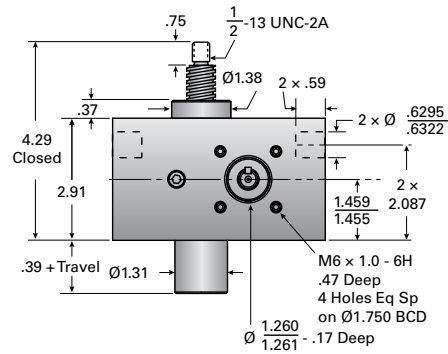

MODEL	Gear Ratio	Turns of Worm for 1" Travel	Max Input Torque (in-lb)	Max allowable Input (hp)	Tare Drag Torque (in-lb)
1C-MSJ	5:1	25	45	$\frac{1}{2}$	3
Capacity: 1 ton Screw: $\frac{3}{4}$ -5	20:1	100	21	$\frac{1}{4}$	3

Screw Specs:
 Root diameter (in): 0.502
 Screw lead (in): 0.200
 Start torque = 2 x Running Torque
 Approximate weight (lbs)
 "0" Travel: 5.2
 Per inch travel: 0.3
 Grease: 0.5

1ABC-MSJ-U UPRIGHT ANTI-BACKLASH

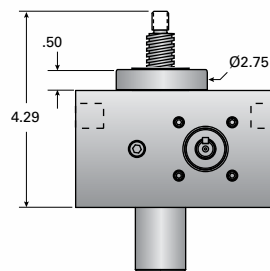

1ABC-MSJ-I INVERTED ANTI-BACKLASH

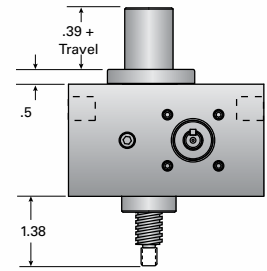

Lifting screw must be secured to prevent rotation for non-keyed units.
 Caution: Jack may be self-lowering in some operating conditions.

1C-MSJ-UR UPRIGHT & INVERTED ROTATING

For ordering, specify "L" dimension
L(min) = travel + 5.07

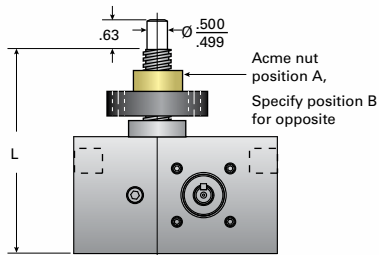

1C-MSJ-UK UPRIGHT & INVERTED KEYED

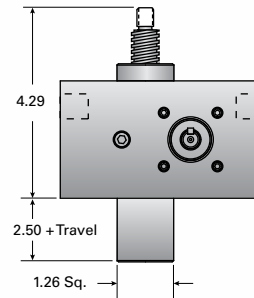

	NON-KEYED			KEYED		
	Torque to raise 1 lb (in-lb)	Max Worm Speed at Rated Load (rpm)	Max Load at 1,750 rpm (lb)	Torque to raise 1 lb (in-lb)	Max Worm Speed at Rated Load (rpm)	Max Load at 1,750 rpm (lb)
	.0225	700	800	.0259	608	695
	.0105	750	857	.0121	651	744

1-MSJ Nut and Flange

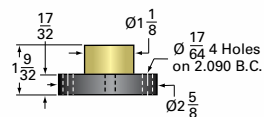

1-MSJ Options (Standard Steel Parts)

Top Plate (optional): 9000-00-11

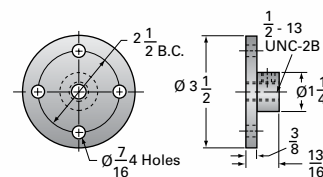

Clevis End (optional): 9001-00-11

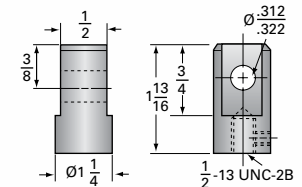

Motor Mounts
see pg 180-181

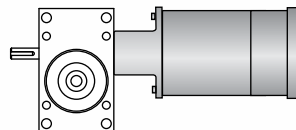

EM05C-BSJ

EM05C-BSJ TOP VIEW

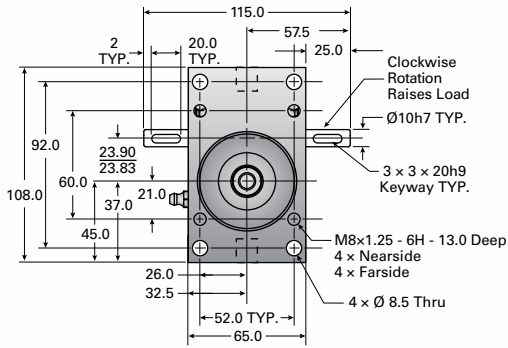

EM05C-BSJ-U UPRIGHT

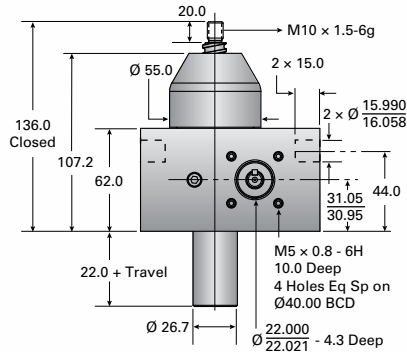

EM05C-BSJ-I INVERTED

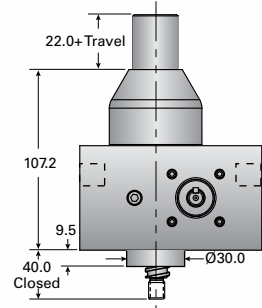

MODEL	Gear Ratio	Capacity (kN)	Raise for One Turn of Worm (mm)	Max Input Torque (N-m)
EM05C-BSJ	5:1	5	1.00	1.21
	20:1	5	0.25	0.51

Screw Specs:
 Screw: MRT 16x5
 Root diameter (mm): 12.9
 Start torque = 1.5 x Running Torque
 Drag torque (N-m): 0.11
 Approximate weight (Kg)
 "0" Travel: 1.58
 Per 100mm travel: 0.14
 Grease: 0.14

Caution: Jack is self-lowering. Lifting screw must be secured to prevent rotation for non-keyed units.

EM05C-BSJ-UR UPRIGHT & INVERTED ROTATING

For ordering, specify "L" dimension
 $L(\text{min}) = \text{travel} + 137$

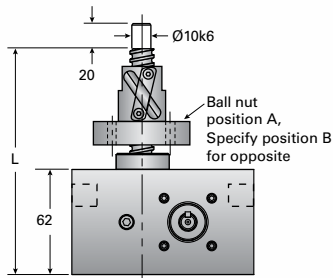

Max Allowable Input (kW)	No Load Torque (N-m)	Backdrive Holding Torque (N-m)	Torque to Raise 1 kN (N-m)	Max Worm Speed at Rated Load (rpm)	Max Load at 1,425 rpm (kN)
0.21	0.11	1.0	.24	1,625	5.0
0.09	0.11	0.5	.10	1,625	5.0

EM05-BSJ Ball Nut and Flange

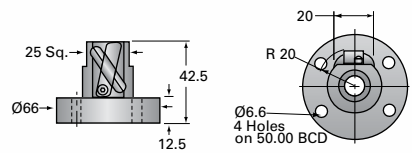

EM05-BSJ Options (Standard Steel Parts)

Top Plate (optional): 9000-EM-12

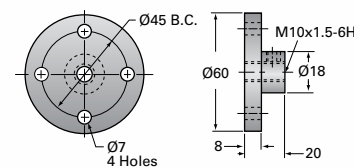

Clevis End (optional): 9001-EM-12

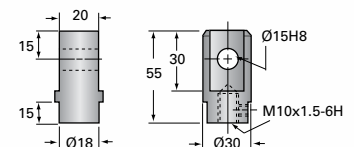

Motor Mounts see pg 180-181

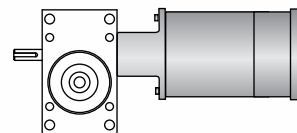

CUBIC JACKS

EM1C-BSJ

EM1C-BSJ TOP VIEW

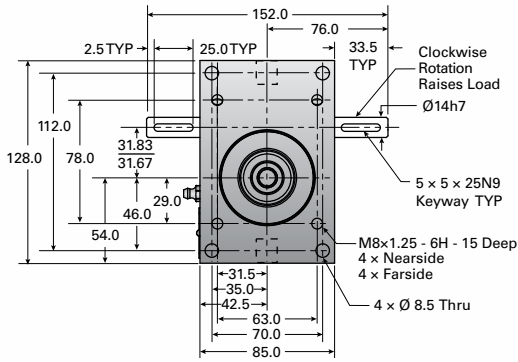

EM1C-BSJ-U UPRIGHT

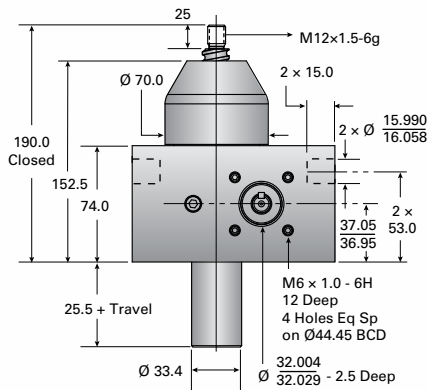

EM1C-BSJ-I INVERTED

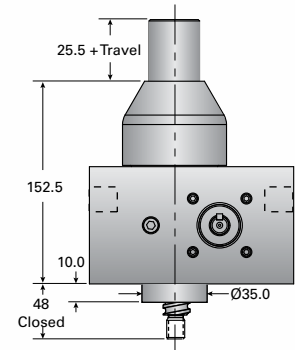

MODEL	Gear Ratio	Capacity (kN)	Raise for One Turn of Worm (mm)	Max Input Torque (N-m)
EM1-BSJ	5:1	10	1.00	2.41
	20:1	10	0.25	1.14

Screw Specs:

- Screw: MRT 20x5
- Root diameter (mm): 17.5
- Start torque = 1.5 x Running Torque
- Drag torque (N-m): 0.34
- Approximate weight (Kg)
 - "0" Travel: 3.3
 - Per 100mm travel: 0.23
 - Grease: 0.23

Caution: Jack is self-lowering. Lifting screw must be secured to prevent rotation for non-keyed units.

EM1C-BSJ-UR UPRIGHT & INVERTED ROTATING

For ordering, specify "L" dimension
 $L(\text{min}) = \text{travel} + 165$

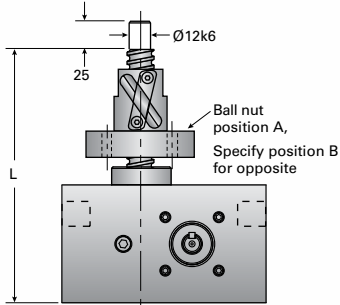

Max Allowable Input (kW)	No Load Torque (N-m)	Backdrive Holding Torque (N-m)	Torque to Raise 1 kN (N-m)	Max Worm Speed at Rated Load (rpm)	Max Load at 1,425 rpm (kN)
0.38	0.34	2.0	.24	1,500	10.0
0.19	0.34	1.0	.11	1,585	10.0

EM1C-BSJ Ball Nut and Flange

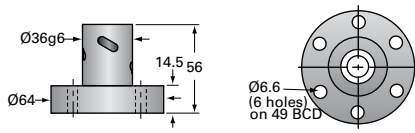

EM1C-BSJ Options (Standard Steel Parts)

Top Plate (optional): 9000-EM-11

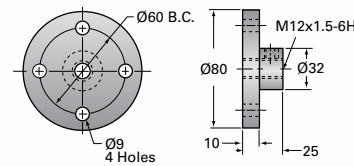

Clevis End (optional): 9001-EM-11

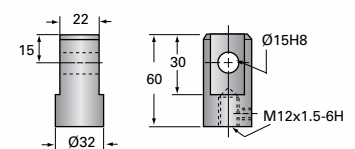

Motor Mounts see pg 180-181

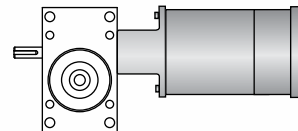

CUBIC JACKS

EM05C-MSJ

EM05C-MSJ TOP VIEW

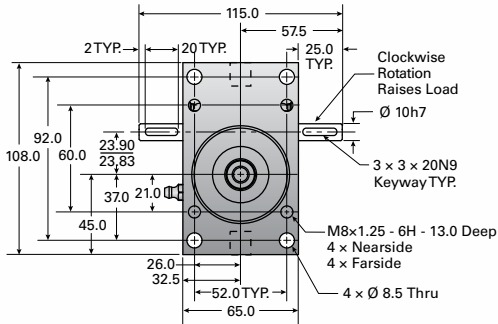

EM05C-MSJ-U UPRIGHT & INVERTED

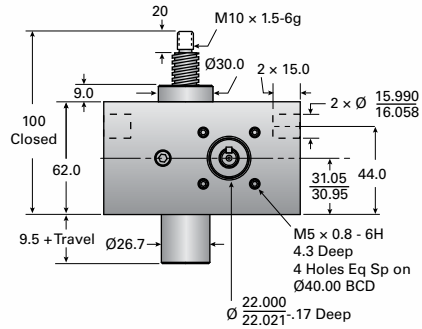

MODEL	Gear Ratio	Capacity (kN)	Raise for One Turn of Worm (mm)	Max Input Torque (N-m)
EM05C-MSJ	5:1	5	0.80	2.25
	20:1	5	0.21	0.94

Screw Specs:
 Screw: Tr16x4
 Root diameter (mm): 10.9
 Start torque = 2 x Running Torque
 Approximate weight (Kg)
 "0" Travel: 1.36
 Per 100mm travel: 0.12
 Grease: 0.23

Lifting screw must be secured to prevent rotation for non-keyed units.
 Caution: Jack may be self-lowering in some operating conditions.

EM05C-MSJ-UR UPRIGHT & INVERTED ROTATING

For ordering, specify "L" dimension
 $L(\text{min}) = \text{travel} + 123$

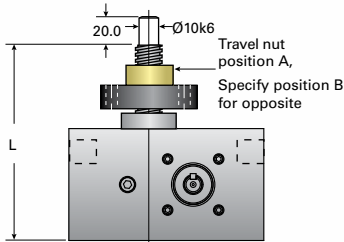

Max Allowable Input (kW)	No Load Torque (N-m)	Torque to Raise 1 kN (N-m)	Max Worm Speed at Rated Load (rpm)	Max Load at 1,425 rpm (kN)
0.27	0.11	0.45	1,130	4.0
0.13	0.11	0.19	1,300	4.6

EM05-MSJ Nut and Flange

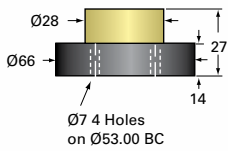

EM05-MSJ Options (Standard Steel Parts)

Top Plate (optional): 9000-EM-12

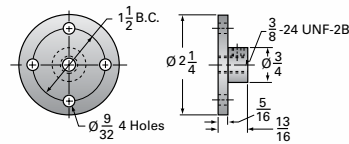

Clevis End (optional): 9001-EM-12

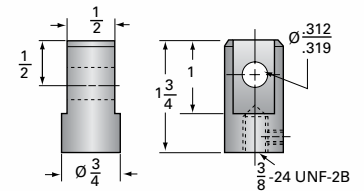

Motor Mounts
 see pg 180-181

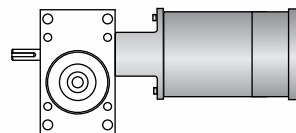

CUBIC JACKS



nookindustries.com

EM1C-MSJ

EM1C-MSJ TOP VIEW

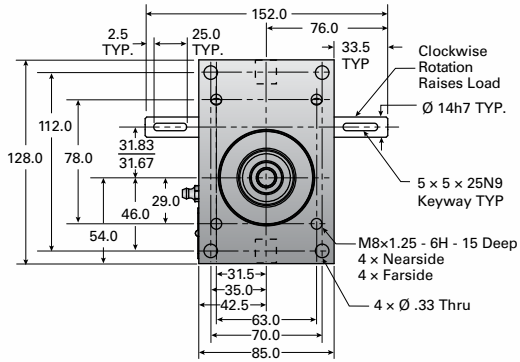

EM1C-MSJ-U UPRIGHT & INVERTED

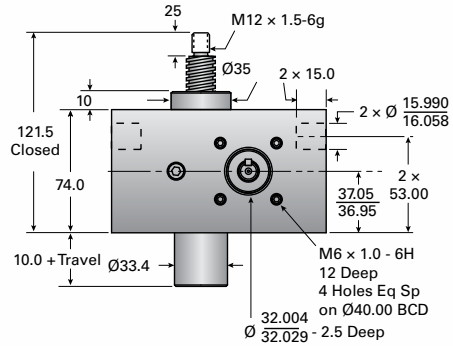

MODEL	Gear Ratio	Capacity (kN)	Raise for One Turn of Worm (mm)	Max Input Torque (N-m)
EM1C-MSJ	5:1	10	0.80	5.19
	20:1	10	0.20	2.44

Screw Specs:
Screw: Tr20x4
Root diameter (mm): 14.9
Start torque = 2 x Running Torque
Approximate weight (Kg)
"0" Travel: 2.4
Per 100mm travel: 0.19
Grease: 0.23

Lifting screw must be secured to prevent rotation for non-keyed units.
Caution: Jack may be self-lowering in some operating conditions.

EM1C-MSJ-UR UPRIGHT & INVERTED ROTATING

For ordering, specify "L" dimension
 L(min) = travel + 143

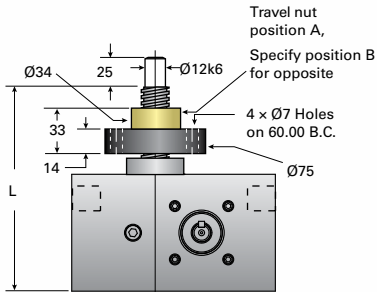

Max Allowable Input (kW)	No Load Torque (N-m)	Torque to Raise 1 kN (N-m)	Max Worm Speed at Rated Load (rpm)	Max Load at 1,425 rpm (kN)
0.36	0.34	0.52 N-m	665 rpm	4.7 kN
0.19	0.34	0.24 N-m	730 rpm	5.1 kN

EM1C-MSJ Options Nut and Flange

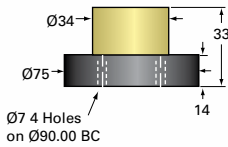

EM1C-MSJ Options (Standard Steel Parts)

Top Plate (optional): 9000-EM-11

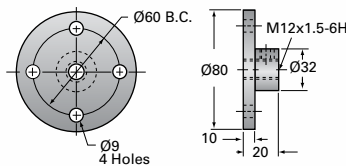

Clevis End (optional): 9001-EM-11

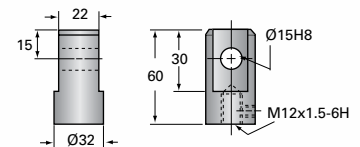

Motor Mounts
 see pg 180-181

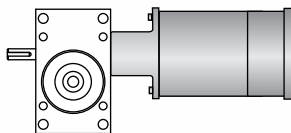

ACCESSORIES

Nook/Thomson offers many accessories to accommodate specific applications. From motor mounts to limit switches to lubricant, Nook/Thomson has the jack accessories to realize the linear motion needs of any application.



MOTOR MOUNTS
pages 180-181



RIGHT ANGLE REDUCERS
page 182-187



HANDBRAKES
page 190



MITER GEAR ASSEMBLIES
page 191

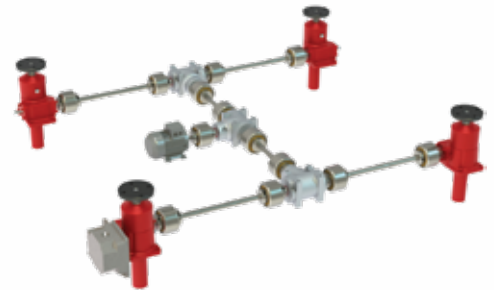

LINKJAC™ SHAFTING
page 192-193

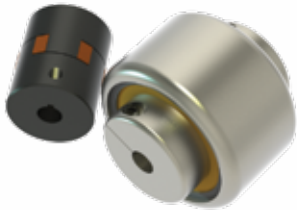

FLEXIBLE COUPLINGS
page 194-195

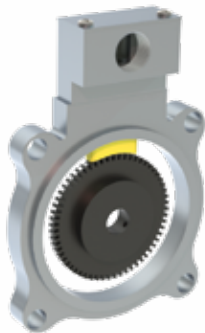

IN-LINE ENCODERS
page 202



COUNTERS
page 203



CONTROL PANELS
page 204-205



MOTORS
 page 188



SERVO/STEPPER MOTORS
 page 188



HANDWHEELS
 page 189



ENVIRONMENTAL JACKS
 page 196-197



ROTARY LIMIT SWITCH
 page 198-199



NOOK SENSOR SYSTEM
 page 200-201



TRUNNION ADAPTERS
 page 206-207



BELLOWS BOOTS
 page 208-209



PILLOW BLOCKS
 page 210



LUBRICATION AND PAINT
 page 211-212

MOTOR MOUNTS WITH AND WITHOUT BRAKEMOTORS

ActionJac™ Motor Mount assemblies are designed for standard motors and include jaw type couplings. These assemblies are available for the jack sizes listed in the table. Non-standard motor mounts can be designed for special requirements including, special couplings, small NEMA frame motors, DIN standard motors, stepper motor and servomotor designs. See page 190 for Servo Jack motor mount examples, contact Nook/Thomson for additional information.

ActionJac™ Worm Gear Screw Jacks can be ordered with industrial quality induction motors. Motors with internally and externally wired brake motors are available. Brake motors utilize an integral, spring actuated brake. Standard motors are 3-phase, 230-460 VAC, 60hz, 1,725 rpm. Single-phase motors are 115-130 VAC, 60hz, 1,725 rpm. All motors are rated for continuous duty. Specific duty motors such as wash down extended duty may be supplied upon request.

See charts for order codes and motor mount dimensions. Additional motor mounts can be custom manufactured for other jack sizes, please contact Nook/Thomson Engineering.

CAUTION: Ball Screw Jacks are self-lowering. A brake of sufficient torque is required to hold the load with a ball screw jack. Be sure to verify that the brakemotor selected has sufficient brake torque for your application.

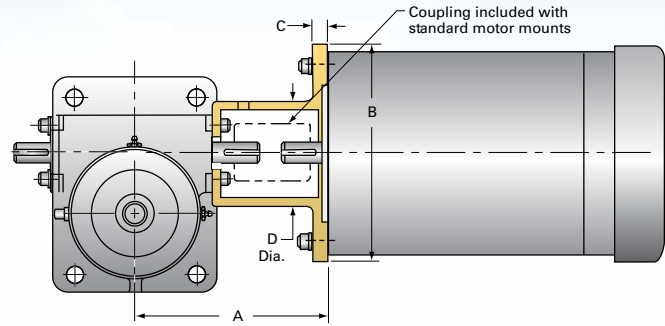

JACK SIZE (TONS)	NEMA FRAME SIZE	PRODUCT CODE WITHOUT MOTOR	DIMENSIONS			
			A	B	C	D
2.5	56C	X05	6.25	6.63	.63	3.50
	140TC	X14	6.25	6.63	.63	3.50
5	56C	X05	7.25	6.75	.56	3.75
	140TC	X14	7.25	6.75	.56	3.75
	180TC	X18	8.00	9.25	.75	3.75
10, 15	56C	X05	8.25	6.75	.50	4.38
	140TC	X14	8.25	6.75	.50	4.38
	180TC	X18	9.00	9.25	.75	4.38
20	56C	X05	8.66	6.75	.50	3.75
	140TC	X14	8.66	6.75	.50	3.75
	180TC	X18	9.00	9.25	.63	5.19
	213TC	X21	9.68	8.88	.88	5.69

MOTOR MOUNT MOUNTING POSITIONS

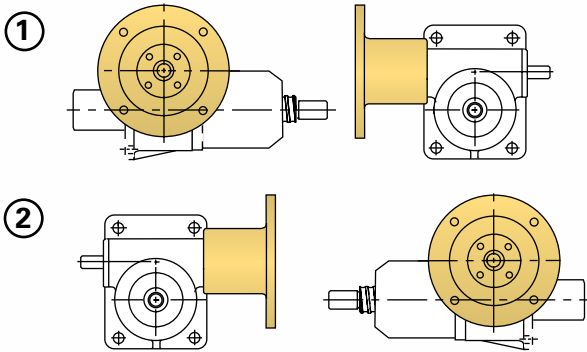

HOW TO ORDER A MOTOR ADAPTER WITH OR WITHOUT A BRAKEMOTOR

EXAMPLE WITHOUT MOTOR:

2.5-BSJ-U 6:1 / **X05-1** / SSE-2 / FT / 12.0 / S

No Motor Order Code — Mounting Position

EXAMPLE WITH MOTOR:

2.5-BSJ-U 6:1 / **10BT-1** / SSE-2 / FT / 12.0 / S

Motor Product Code — Mounting Position
(see page 188)

For all other sizes and configurations, contact Nook/Thomson Engineering.



METRIC MOTOR MOUNTS

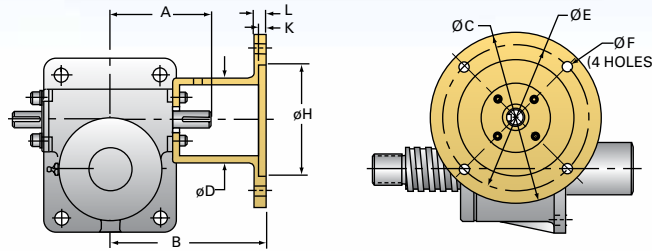

MODEL	IEC FRAME MOTOR SIZE (PRODUCT CODE)	A REF	B	ØC	ØD	ØE	ØF	ØH	K	L
EM05-BSJ EM05-MSJ	56B5	57.5	100	120	64	100	8.5	80	3.5	7
	56B14	57.5	100	80	64	65	6	50	3.0	6
EM1-BSJ EM1-MSJ	63B5	76	114	140	70	115	9	95	4	8
	63B14	76	114	90	70	75	6	60	3.5	8
	71B5	76	120	160	85	130	9	110	4.5	10
	71B14	76	120	105	85	85	7	70	4	10
EM2.5-BSJ EM2.5-MSJ	71B5	90	135	160	85	130	9	110	4.5	10
	71B14	90	135	105	85	85	7	70	4	10
	80B5	90	145	200	85	165	11	130	4.5	12
	80B14	90	145	120	85	100	7	80	4.5	12
EM5-BSJ EM5-MSJ	80B5	115	180	200	98	165	11	130	4.5	12
	80B14	115	170	120	96	100	7	80	4.5	12
	90B5	115	180	200	96	165	11	130	4.5	12
	90B14	115	180	140	96	115	9	95	4.5	12
EM10-BSJ EM10-MSJ	90B5	140	207	200	116	165	11	130	4.5	12
	90B14	140	207	140	116	115	9	95	4.5	12
	100B5	140	217	250	116	215	13	180	5	14
	100B14	140	217	160	116	130	9	110	5	14
EM20-BSJ EM20-MSJ	100B5	150	230	250	134	215	13	180	5	14
	100B14	150	230	160	134	130	9	110	5	14

RIGHT ANGLE REDUCERS

The right angle reducer is a secondary worm gear reducer that reduces speed and increases torque to the input of the jack. If motor clearance is an issue, a right angle reducer may be added to most jacks to optimize motor orientation. Right-Angle Reducers are available in two different styles; High Efficiency and Standard Efficiency.

Right Angle Reducers may be installed on the standard ActionJac™ Machine Screw and Ball Screw Jacks listed below at the time of the order and are available with or without brakemotors.

HIGH EFFICIENCY RIGHT-ANGLE REDUCERS

The High Efficiency Right-Angle Reducer is a compact, high quality worm gear reducer enclosed in an aluminum casted housing. The reducer mounts directly to the input side of the jack. Motors mount quill-style to a standard NEMA C-face. The High Efficiency Right-Angle Reducers are non-vented, oil filled, and maintenance free. They are rated at 85% or greater efficiency - allowing for a smaller drive and motor when compared with standard efficiency right-angle reducers.

High Efficiency Right-Angle Reducers are available in a variety of NEMA motor mounts.

Consult the data charts for jack capacity when a Right-Angle Reducer is used. Ratings given on the chart may differ when a Right-Angle Reducer is installed on Keyed or Anti-Backlash Machine Screw Jack models. Special consideration must be given when installing onto a Double-Clevis Jack due to the additional weight of the reducer.

Max input RPM is 1725rpm.

HOW TO ORDER A RIGHT-ANGLE REDUCER

Right-Angle Reducer ratio, mounting position, and brakemotor size and type must be specified. The data chart below gives order codes for Right-Angle Reducers with and without brakemotors. Insert the order code and mounting position as shown on page 31, 69, 103, 123, 141, and 161.

EXAMPLE: 2.5-BSJ-U 6:1 / **05BTR7 - 7** / 2CA-2 / FT / 24.5 / S

Motor Product Code (see page 188) | Mounting Position (see page 185)

CODE	Gear Ratio
R5	5:1
R7	7.5:1
R10	10:1
R15	15:1



BALL SCREW JACKS

Jack Model-Ratio	Reducer Ratio	Travel Rate*	Dynamic Capacity per Motor Horsepower (lb) **					
			¼	⅓	½	¾	1	1½
2.5-BSJ-6:1	5:1	14.38	3,780	5,000	-	-	-	-
	7.5:1	9.58	5,000	-	-	-	-	-
	10:1	7.19	5,000	-	-	-	-	-
	15:1	4.79	5,000	-	-	-	-	-
2.5-BSJ-24:1	5:1	3.59	5,000	-	-	-	-	-
	7.5:1	2.40	5,000	-	-	-	-	-
	10:1	1.80	5,000	-	-	-	-	-
	15:1	1.20	5,000	-	-	-	-	-
2.5HL-BSJ-6:1	5:1	57.50	950	1,270	1,910	2,860	3,820	5,000
	7.5:1	38.33	1,400	1,860	2,800	4,190	5,000	-
	10:1	28.75	1,820	2,430	3,640	5,000	-	-
	15:1	19.17	2,640	3,520	5,000	-	-	-

* measured in in/min at the max rated rpm of 1,725 rpm

** Full nominal static capacity of jack is retained

BALL SCREW JACKS

Jack Model-Ratio	Reducer Ratio	Travel Rate*	Dynamic Capacity per Motor Horsepower (lb)**				
			½	¾	1	1½	2
5-BSJ-6:1	5:1	27.24	4,210	6,320	8,430	10,000	-
	7.5:1	18.16	6,260	9,400	10,000	-	-
	10:1	13.62	8,140	10,000	-	-	-
	15:1	9.08	10,000	-	-	-	-
5-BSJ-24:1	5:1	6.81	10,000	-	-	-	-
	7.5:1	4.54	10,000	-	-	-	-
	10:1	3.40	10,000	-	-	-	-
	15:1	2.27	10,000	-	-	-	-
5HL-BSJ-6:1	5:1	57.50	1,990	2,990	3,990	5,980	7,970
	7.5:1	38.33	2,960	4,440	5,920	8,890	10,000
	10:1	28.75	3,850	5,780	7,700	10,000	-
	15:1	19.17	5,510	8,270	10,000	-	-
5HL-BSJ-24:1	5:1	14.38	5,040	7,560	-	-	-
	7.5:1	9.58	7,490	10,000	-	-	-
	10:1	7.19	9,740	10,000	-	-	-
	15:1	4.79	10,000	-	-	-	-
10-BSJ-8:1	7.5:1	13.62	-	11,370	15,160	20,000	-
	10:1	10.21	-	15,000	20,000	-	-
	15:1	6.81	-	20,000	-	-	-
10-BSJ-24:1	7.5:1	4.54	-	20,000	-	-	-
	10:1	3.40	-	20,000	-	-	-
	15:1	2.27	-	20,000	-	-	-
10HL-BSJ-8:1	7.5:1	28.75	-	5,380	7,180	10,760	14,350
	10:1	21.56	-	7,100	9,470	14,200	18,930
	15:1	14.38	-	10,170	13,560	20,000	-
20-BSJ-8:1	7.5:1	14.38	-	-	-	22,130	29,510
	10:1	10.78	-	-	-	29,140	38,860
	15:1	7.19	-	-	-	40,000	-
20-BSJ-24:1	7.5:1	4.79	-	-	-	40,000	-
	10:1	3.59	-	-	-	40,000	-
	15:1	2.39	-	-	-	40,000	-
20HL-BSJ-8:1	7.5:1	28.75	-	-	-	11,100	14,800
	10:1	21.56	-	-	-	14,620	19,490
	15:1	14.38	-	-	-	21,180	28,240
20HL-BSJ-24:1	7.5:1	9.58	-	-	-	22,130	29,510
	10:1	7.18	-	-	-	29,140	38,860
	15:1	4.79	-	-	-	40,000	-

* measured in in./min. @ 1,725 rpm

** Full nominal static capacity of jack is retained

RIGHT ANGLE REDUCERS (CONTINUED)

HIGH EFFICIENCY RIGHT-ANGLE REDUCERS

MACHINE SCREW JACKS

Jack Model-Ratio	Reducer Ratio	Travel Rate*	Dynamic Capacity per Motor Horsepower (lb)**						
			¼	⅓	½	¾	1	1½	2
2.5-MSJ-6:1	5	14.38	1,530	2,040	3,060	4,590	5,000	–	–
	7.5	9.58	2,240	2,990	4,480	5,000	–	–	–
	10	7.19	2,920	3,890	5,000	–	–	–	–
	15	4.79	4,230	5,000	–	–	–	–	–
2.5-MSJ-24:1	5	3.59	3,640	4,850	5,000	–	–	–	–
	7.5	2.40	5,000	–	–	–	–	–	–
	10	1.80	5,000	–	–	–	–	–	–
	15	1.20	5,000	–	–	–	–	–	–
5-MSJ-6:1	5	21.56	–	–	2,050	3,080	4,100	6,150	8,210
	7.5	14.38	–	–	3,050	4,570	6,100	9,150	10,000
	10	10.78	–	–	3,960	5,940	7,930	10,000	–
	15	7.19	–	–	5,670	8,510	10,000	–	–
5-MSJ-24:1	5	5.39	–	–	5,360	8,030	–	–	–
	7.5	3.59	–	–	7,960	–	–	–	–
	10	2.70	–	–	10,000	–	–	–	–
	15	1.80	–	–	10,000	–	–	–	–
10-MSJ-8:1	7.5	14.38	–	–	–	4,550	6,070	9,110	12,140
	10	10.78	–	–	–	6,010	8,010	12,020	16,020
	15	7.19	–	–	–	8,610	11,480	17,210	20,000
10-MSJ-24:1	7.5	4.79	–	–	–	8,940	11,920	17,880	–
	10	3.59	–	–	–	11,800	15,730	20,000	–
	15	2.40	–	–	–	16,900	20,000	–	–
15-MSJ-8:1	7.5	14.38	–	–	–	4,220	5,620	8,440	11,250
	10	10.78	–	–	–	5,570	7,420	11,130	14,840
	15	7.19	–	–	–	7,970	10,630	15,950	21,260
15-MSJ-24:1	7.5	5.99	–	–	–	7,880	10,500	15,750	–
	10	3.59	–	–	–	10,390	13,850	20,780	–
	15	2.40	–	–	–	14,880	19,850	29,770	–
20-MSJ-8:1	7.5	14.38	–	–	–	–	–	7,990	10,650
	10	10.78	–	–	–	–	–	10,520	14,030
	15	7.19	–	–	–	–	–	15,240	20,320
20-MSJ-24:1	7.5	4.79	–	–	–	–	–	15,940	21,250
	10	3.59	–	–	–	–	–	20,990	27,990
	15	2.40	–	–	–	–	–	30,410	40,000

* measured in in./min. @ 1,725 rpm

** Full nominal static capacity of jack is retained

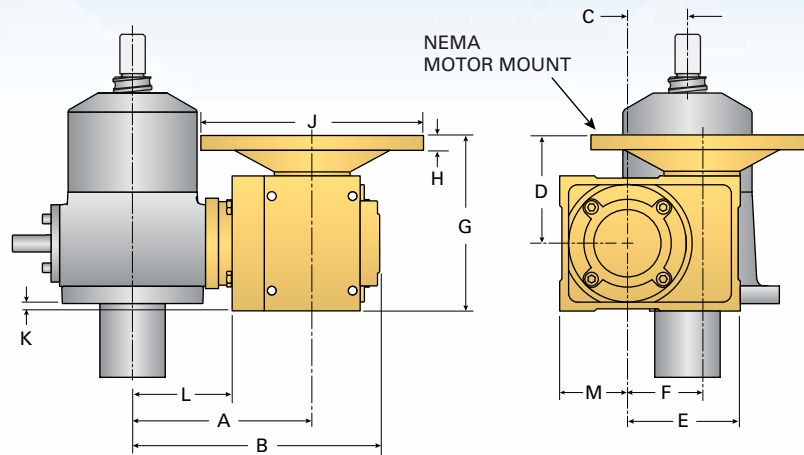

JACK SIZE	NEMA FRAME	Dimensions (in)											
		A	B	C	D	E	F	G	H	J	K	L	M
2.5	56C	5.63	7.60	1.75	3.15	2.81	1.58	5.12	0.43	6.50	0.22	3.19	1.97
5 TON	56C	7.59	10.09	2.19	3.54	3.31	1.97	5.90	0.43	6.50	0.11	4.40	2.36
10/15 TON	56C / 140TC	9.22	11.92	2.60	4.13	4.02	2.46	6.96	0.43	6.50	0.55	3.62	2.83
20 TON	56C / 140TC	9.67	12.56	2.88	4.96	4.69	2.95	8.35	0.43	6.50	0.10	2.60	3.38

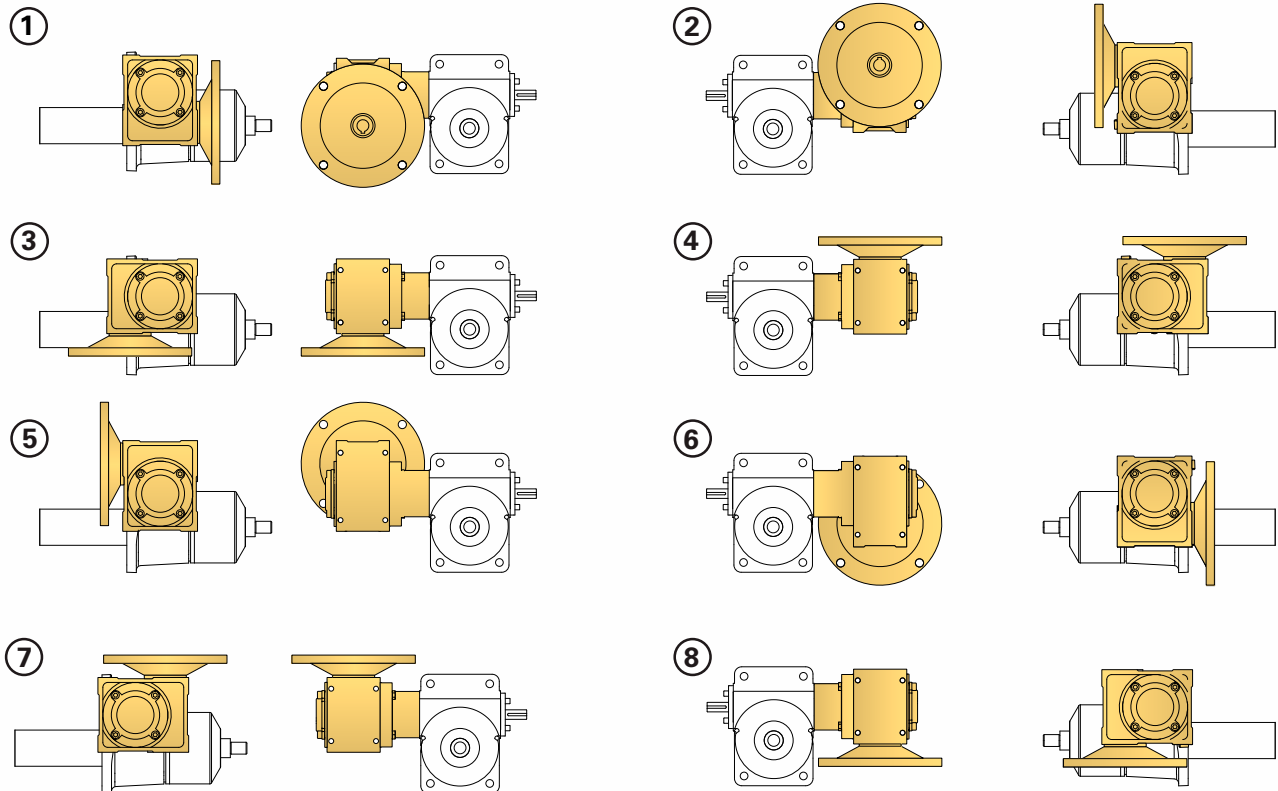

RIGHT ANGLE REDUCERS

STANDARD EFFICIENCY RIGHT-ANGLE REDUCERS

The Standard Efficiency Right-Angle Reducer is a compact, high quality worm gear reducer enclosed in a ductile iron housing. The reducer mounts directly to the input side of the jack. Motors mount quill-style to a standard NEMA C-face.

Consult the data charts for jack capacity when a Right-Angle Reducer is used. Ratings given on the chart may differ when a Right-Angle Reducer is installed on Keyed or Anti-Backlash Machine Screw Jack models. Special consideration must be given when installing onto a Double-Clevis Jack due to the additional weight of the reducer.

HOW TO ORDER A STANDARD EFFICIENCY RIGHT-ANGLE REDUCER

Right-Angle Reducer ratio, mounting position, and brakemotor size and type must be specified. The data chart below gives order codes for Right-Angle Reducers with and without brakemotors. Insert the order code and mounting position as shown on page 31, 69, 103, 123, 141, and 161.

EXAMPLE: 2.5-BSJ-U 6:1 / 2CA-1 / **05BTR6 - 4** / FT / 24.5 / S

Product Code  Mounting Position 

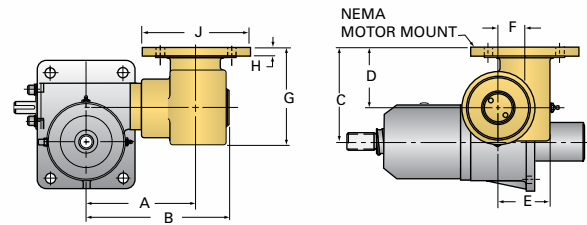

BALL SCREW JACKS

Jack Model-Ratio	Reducer Ratio	Travel Rate*	Brake Motor (hp)	Dynamic Capacity (lbs)**	PRODUCT CODE***				REDUCER DIMENSIONS (in)								
					W/1-Ph Motor	W/3-Ph Motor	Without Motor	Motor Size	A	B	C	D	E	F	G	H	J
2.5-BSJ-6:1	6:1	12.0	1/2	5,000	05BSR6	05RTR6	X05R6	56C	5.63	7.44	5.44	3.69	3.31	1.750	5.88	.50	6.69
	12:1	5.99	1/3	5,000	03BSR12	03RTR12	X05R12	56C	5.63	7.44	5.44	3.69	3.31	1.750	5.88	.50	6.69
2.5-BSJ-24:1	6:1	2.99	1/4	5,000	02BSR6	02RTR6	X05R6	56C	5.63	7.44	5.44	3.69	3.31	1.750	5.88	.50	6.69
	12:1	1.48	1/4	5,000	02BSR12	02RTR12	X05R12	56C	5.63	7.44	5.44	3.69	3.31	1.750	5.88	.50	6.69
2.5HL-BSJ-6:1	6:1	47.9	1	3,550	10BSR6	10RTR6	X05R6	56C	5.63	7.44	5.44	3.69	3.31	1.750	5.88	.50	6.69
	12:1	24.0	1	5,000	10BSR12	10RTR12	X05R12	56C	5.63	7.44	5.44	3.69	3.31	1.750	5.88	.50	6.69
5-BSJ-6:1	6:1	22.7	1	7,500	10BSR6	10RTR6	X05R6	56C	6.50	8.50	5.88	3.69	3.31	1.750	5.88	.50	6.69
	12:1	11.3	1	10,000	10BSR12	10RTR12	X05R12	56C	6.50	8.50	5.88	3.69	3.31	1.750	5.88	.50	6.69
5-BSJ-24:1	6:1	5.67	1	10,000	10BSR6	10RTR6	X05R6	56C	6.50	8.50	5.88	3.69	3.31	1.750	5.88	.50	6.69
	12:1	2.83	1/2	10,000	05BSR12	05RTR12	X05R12	56C	6.50	8.50	5.88	3.69	3.31	1.750	5.88	.50	6.69
5HL-BSJ-6:1	6:1	47.9	1	3,500	10BSR6	10RTR6	X05R6	56C	6.50	8.50	5.88	3.69	3.31	1.750	5.88	.50	6.69
5HL-BSJ-24:1	6:1	12.0	1	8,000	10BSR6	10RTR6	X05R6	56C	6.50	8.50	5.88	3.69	3.31	1.750	5.88	.50	6.69
10-BSJ-8:1	6:1	17.0	1	9,000	10BSR6	10RTR6	X05R6	56C	7.25	9.25	6.29	3.69	3.31	1.750	5.88	.50	6.69
	12:1	8.50	1	15,000	10BSR12	10RTR12	X05R12	56C	7.25	9.25	6.29	3.69	3.31	1.750	5.88	.50	6.69
10-BSJ-24:1	6:1	5.67	1	17,000	10BSR6	10RTR6	X05R6	56C	7.25	9.25	6.29	3.69	3.31	1.750	5.88	.50	6.69
	12:1	2.83	1	20,000	10BSR12	10RTR12	X05R12	56C	7.25	9.25	6.29	3.69	3.31	1.750	5.88	.50	6.69
10HL-BSJ-8:1	6:1	35.9	1	4,275	10BSR6	10RTR6	X05R6	56C	7.25	9.25	6.29	3.69	3.31	1.750	5.88	.50	6.69
20-BSJ-8:1	8:1	13.5	3	35,000	N/A	30RTR8	X18R8	180TC	9.00	11.75	9.00	6.12	5.38	2.875	9.00	.88	9.12
20-BSJ-24:1	8:1	4.49	2	40,000	N/A	20RTR8	X18R8	180TC	9.00	11.75	9.00	6.12	5.38	2.875	9.00	.88	9.12
20HL-BSJ8:1	8:1	26.9	5	30,000	N/A	50RTR8	X18R8	180TC	9.00	11.75	9.00	6.12	5.38	2.875	9.00	.88	9.12
20HLBSJ-24:1	8:1	8.98	3	35,000	N/A	30RTR8	X18R8	180TC	9.00	11.75	9.00	6.12	5.38	2.875	9.00	.88	9.12

* measured in in/min.@ 1,725 rpm

** Full nominal static capacity of jack is retained

*** Motor specified is internally wired brake motor, for additional motor options see page 188

RIGHT-ANGLE REDUCER POSITIONS

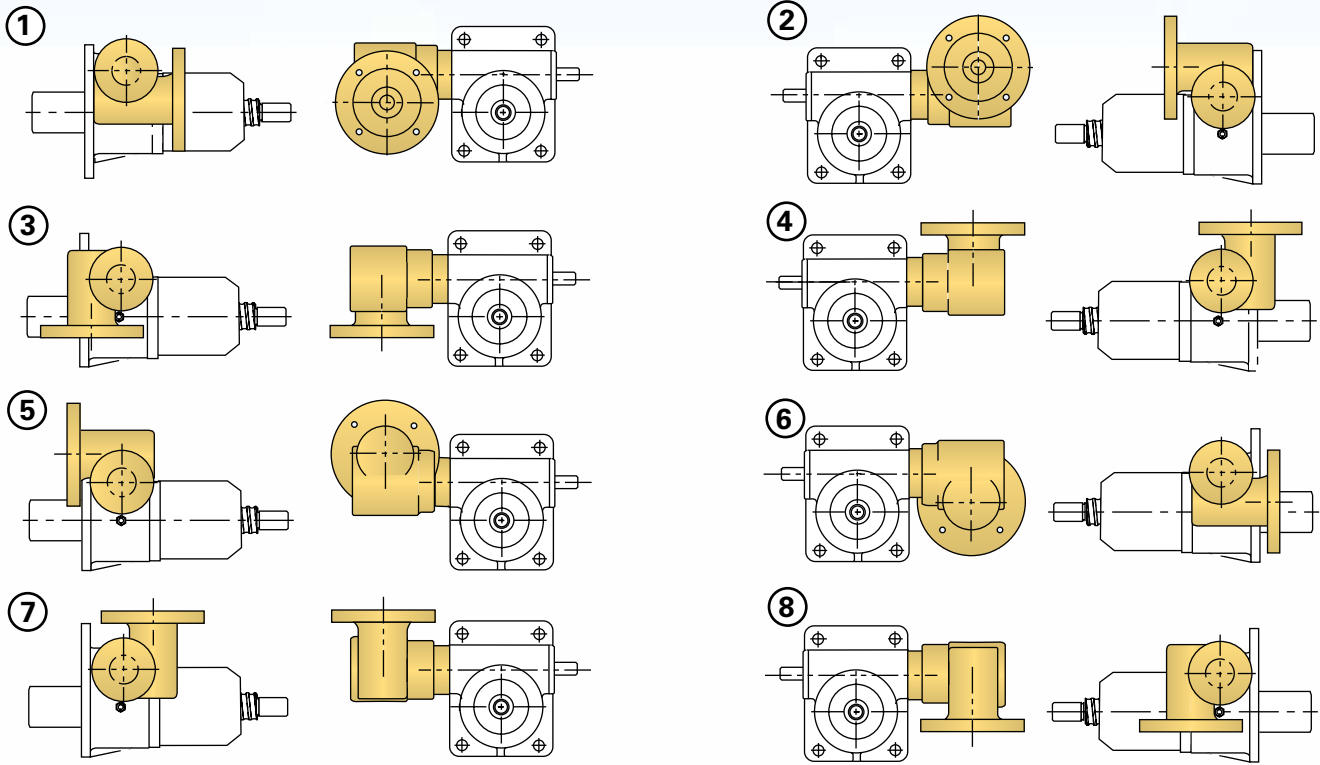

MACHINE SCREW JACKS

Jack Model-Ratio	Reducer Ratio	Travel Rate*	Brake Motor (hp)	Dynamic Capacity (lbs)**	PRODUCT CODE			Motor Size	REDUCER DIMENSIONS (in)								
					W/1-Ph Motor	W/3-Ph Motor	Without Motor		A	B	C	D	E	F	G	H	J
2.5-MSJ-6:1	6:1	12.0	¼	5,000	07BSR6	07RTR6	X05R6	56C	5.63	7.44	5.44	3.69	3.31	1.750	5.88	.50	6.69
	12:1	5.99	½	5,000	05BSR12	05RTR12	X05R12	56C	5.63	7.44	5.44	3.69	3.31	1.750	5.88	.50	6.69
2.5-MSJ-24:1	6:1	2.99	⅓	5,000	03BSR6	03RTR6	X05R6	56C	5.63	7.44	5.44	3.69	3.31	1.750	5.88	.50	6.69
	12:1	1.48	⅓	5,000	03BSR12	03RTR12	X05R12	56C	5.63	7.44	5.44	3.69	3.31	1.750	5.88	.50	6.69
5-MSJ-6:1	6:1	18.0	1	4,500	10BSR6	10RTR6	X05R6	56C	6.50	8.50	5.88	3.69	3.31	1.750	5.88	.50	6.69
	12:1	8.98	1	5,000	10BSR12	10RTR12	X05R12	56C	6.50	8.50	5.88	3.69	3.31	1.750	5.88	.50	6.69
5-MSJ-24:1	6:1	4.49	1	10,000	10BSR6	10RTR6	X05R6	56C	6.50	8.50	5.88	3.69	3.31	1.750	5.88	.50	6.69
	12:1	2.25	1	10,000	10BSR12	10RTR12	X05R12	56C	6.50	8.50	5.88	3.69	3.31	1.750	5.88	.50	6.69
10-MSJ-8:1 15-MSJ-8:1	6:1	18.0	1	3,800	10BSR6	10RTR6	X05R6	56C	7.25	9.25	6.29	3.69	3.31	1.750	5.88	.50	6.69
	12:1	8.98	1	6,275	10BSR12	10RTR12	X05R12	56C	7.25	9.25	6.29	3.69	3.31	1.750	5.88	.50	6.69
10-MSJ-24:1 15-MSJ-24:1	6:1	5.99	1	7,000	10BSR6	10RTR6	X05R6	56C	7.25	9.25	6.29	3.69	3.31	1.750	5.88	.50	6.69
	12:1	2.99	1	10,000	10BSR12	10RTR12	X05R12	56C	7.25	9.25	6.29	3.69	3.31	1.750	5.88	.50	6.69
20-MSJ-8:1	8:1	13.5	7½	31,000	N/A	75RTR8	X21R8	210TC	9.00	11.75	9.00	6.12	5.38	2.875	9.00	.88	9.12
	8:1	13.5	5	22,500	N/A	50RTR8	X18R8	180TC	9.00	11.75	9.00	6.12	5.38	2.875	9.00	.88	9.12
20-MSJ-24:1	8:1	4.49	3	25,000	N/A	30RTR8	X18R8	180TC	9.00	11.75	9.00	6.12	5.38	2.875	9.00	.88	9.12

* measured in in/min.@ 1,725 rpm

** Full nominal static capacity of jack is retained

BRAKEMOTOR REFERENCE

ActionJac™ Worm Gear Screw jacks can be supplied with industrial quality. Brake motors include a spring actuated, electrically released braking mechanism which will hold a load when the power is off. In normal operation, power is applied and removed to the motor windings and brake release simultaneously.

If it is desired to operate the brake separately, as when used with a speed control, the brake needs to be wired externally. Motors provided by Nook/Thomson can either be supplied with the brake wired externally to accommodate speed controllers, or internally for simplicity of use.

Standard motors are: 3 phase 208-230 / 460 VAC, 60 Hz. 1,725 rpm. Also available are single phase motors at: 115 / 230 VAC, 60 Hz. 1,725 rpm. Standard 3 phase and single phase motors are rated for 50% duty. Wash Down and Explosion Proof motors are rated for continuous duty.

NOTE: for inverter duty motors or additional options, contact Nook/Thomson.

For HOW TO ORDER see page 180.

EXTERNALLY WIRED BRAKE MOTOR PRODUCT CODE

INTERNALLY WIRED BRAKE MOTOR

Motor HP	STD Motor 208-230/460 3PH [Brake ft-lbs.]	Wash Down MOTOR IP55 • 208-230/460 3PH [Brake ft-lbs.]	Explosion Proof DIVISION 1 • CLASS 1,2 • GROUP F & G • 208/230/460 • 3PH [Brake ft-lbs.]	Economy Motor* 208-230/460 3PH SLIPPAGE ~ 10% [Brake ft-lbs.]	Single Phase 115/230 1PH [Brake ft-lbs.]
1/4	-	-	-	02MT [7]	02BS [3]
1/3	-	-	-	03MT [7]	03BS [3]
1/2	05RT [3]	05RW [3]	05RE [3]	05MT [7]	05BS [3]
3/4	07RT [6]	07RW [6]	07RE [6]	07MT [7]	07BS [6]
1	10RT [6]	10RW [6]	10RE [6]	10MT [7]	10BS [3]
1 1/2	15RT [6]	15RW [10]	-	15MT [9]	-
2	20RT [10]	20RW [10]	20RE [10]	20MT [20]	-
3	30RT [15]	30RW [15]	30RE [15]	30MT [20]	-
5	50RT [25]	50RW [25]	50RE [25]	50MT [25]	-
7 1/2	75RT [35]	-	-	75MT [40]	-

* Motor rpm between 1620 and 1680 for Economy motors. For speed critical application please contact Nook/Thomson Engineering.

SERVO/STEPPER MOTORS

ActionJac™ Servo or Stepper Jacks offer the ability to attach a servo or stepper motor to a ball screw or machine screw jack. Using a servo or stepper motor increases control of acceleration, deceleration, travel rate and positioning accuracy compared with standard NEMA framed motors.

Custom Motor Adaptors are designed to accommodate any specified coupling and motor. Servo or Stepper Jacks can be delivered as a complete assembly, including a vendor-specified motor. Contact Nook/Thomson for further assistance with jack applications requiring servo or stepper motors.



Below is a partial list of companies we have designed planetary gear reducer adapters for:

- _____
- Bayside
- _____
- Apex
- _____
- Alpha
- _____
- CGI

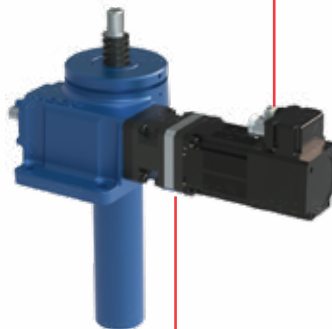

Below is a partial list of companies we have designed servo and stepper motor adaptors for:

- _____
- Allen Bradley
- _____
- Baldor
- _____
- Reliance
- _____
- Kollmorgen
- _____
- Mitsubishi
- _____
- Siemens
- _____
- Applied Motion
- _____
- Yasawa
- _____
- Parker
- _____
- Bosch Rexroth

HANDWHEELS

A handwheel is a convenient solution for manually operating a jack when using machine screw jacks in intermittent positioning applications. Handwheels are available in a range of diameters from 4 to 10 inches and can be adapted for use on jacks from the MJ series up to the 20 ton capacity model.

NOTE: Handwheels do not include a brake and therefore are not for use with ball screw jacks. When using handwheels with a jack that can backdrive (12:1 and lower) an additional locking mechanism may be required to prevent "creep."

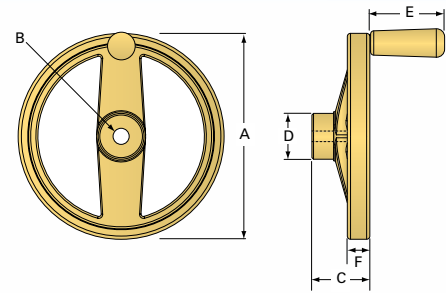

JACK SIZE	A	B	C	D	E	F	Product Code
MJ	4	.375	1½	1 ³ / ₁₆	1 ⁵ / ₈	5 ⁵ / ₈	H043
1-MSJ	4	.50	1½	1 ³ / ₁₆	1 ⁵ / ₈	5 ⁵ / ₈	H044
	6	.50	2	1 ⁹ / ₁₆	2 ⁹ / ₁₆	¾	H064
2-MSJ	4	.50	1½	1 ³ / ₁₆	1 ⁵ / ₈	5 ⁵ / ₈	H044
	6	.50	2	1 ⁹ / ₁₆	2 ⁹ / ₁₆	¾	H064
2.5-MSJ	4	.50	1½	1 ³ / ₁₆	1 ⁵ / ₈	5 ⁵ / ₈	H044
	6	.50	2	1 ⁹ / ₁₆	2 ⁹ / ₁₆	¾	H064
5-MSJ	6	.75	2	1 ⁹ / ₁₆	2 ⁹ / ₁₆	¾	H066
	8	.75	2¼	1 ²⁵ / ₃₂	2 ¹⁵ / ₁₆	7 ⁷ / ₈	H086
	10	.75	3	2¼	3 ¹⁵ / ₁₆	1	H106
10-MSJ	8	1	2¼	1 ²⁵ / ₃₂	2 ¹⁵ / ₁₆	7 ⁷ / ₈	H088
	10	1	3	2¼	3 ¹⁵ / ₁₆	1	H108
15-MSJ	8	1	2¼	1 ²⁵ / ₃₂	2 ¹⁵ / ₁₆	7 ⁷ / ₈	H088
	10	1	3	2¼	3 ¹⁵ / ₁₆	1	H108
20-MSJ	8	1	2¼	1 ²⁵ / ₃₂	2 ¹⁵ / ₁₆	7 ⁷ / ₈	H088
	10	1	3	2¼	3 ¹⁵ / ₁₆	1	H108

HOW TO ORDER A JACK WITH A HANDWHEEL

EXAMPLE:

2.5-MSJ-U 24:1 / **H064-1** / SSE-2 / FT / 12.0 / S

Product Code (from chart above) ———— Mounting Position



HANDBRAKES

A handbrake is a convenient solution for manually securing machine screw jacks. Handbrakes can be used on machine screw jacks 2.5 ton to the 5 ton capacity.

Handbrakes can be ordered with either a standard shaft extension, an extended shaft extension, or with a handwheel. See page 189 for handwheel details.

HANDBRAKE AS A KIT

Handbrake Kits come with Handbrake, Adjustable Handle, two socket head cap screw (SHCS), and two lock washers. To install, remove two adjacent SHCS, and lock washers securing the End Cap. Discard SHCS and lock washers. Clean shaft from any debris or contamination. Slide the Handbrake over the shaft until fully against the End Cap. Install the provided SHCS and lock washers in place of the two that were removed, securing the Handbrake and End Cap in place.

Jack Size	Kit Part Number
2.5-MSJ	HB-025
5-MSJ	HB-050



HANDBRAKE POSITIONS



HOW TO ORDER A JACK WITH A HANDBRAKE

EXAMPLE:

2.5-MSJ-U 6:1 / **HBT-1** / SSE-2 / FT / 12.0 / S

Product Code (from chart above) ┌ └ Mounting Position

Example of counter designations:

HBT-2 = Handbrake with extended shaft extension, position 2
Dash number designates mounting position

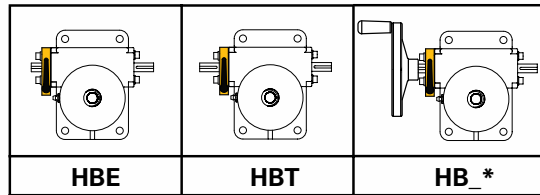

Product Code	Shaft Extension
HBE	standard shaft extension
HBT	extended shaft extension
HBA	with 4" handwheel*
HBB	with 6" handwheel*
HBC	with 8" handwheel*
HBD	with 10" handwheel*

*See handwheel page 189 to select the correct size for jack model

CAUTION - Handbrakes are only intended to prevent "creep" due to vibration with machine screw jacks only. They are not designed to be used with ball screw jacks.

Depending on the magnitude of vibration and application life cycles, the handbrake may not be sufficient to secure the load.

Handbrakes are not intended to be used where personal injury could occur.

STANDARD MITER GEAR ASSEMBLIES

GEAR RATIO 1:1 AND 2:1

Jacks may be used in multiple arrangements by connecting shafting, couplings and gear boxes to simultaneously transmit power to the input shafts of the jacks. Nook/Thomson provides gearboxes for use with jacks. Make certain that the total torque and horsepower required by the arrangement does not exceed the ratings of the box. For optimum life and noise levels, operate below 900 rpm. Higher speeds are permissible at lower torque ratings. Noise levels may increase at higher speeds. The operating efficiency of a miter gear box is 90%.

Model	Gear Ratio	Rated Load at 1700 rpm				Est. Weight (lb)
		Continuous Duty		Intermittent Duty		
		HP	Torque (in-lb)	HP	Torque (in-lb)	
GB210	1:1	7.67	284	14.44	535	6¼
GB210S*	1:1	5.75	213.24	10.82	401.32	6¼
GB210S-R2*	2:1	3.01	111.54	5.56	206.31	6¼
GB15	1:1	30.5	1,131	38.33	1,421	26
GB12**	1:1	60.51	2724.13	70.48	3172.91	39

* Spiral bevel gear set
** Rated Load calculated at 1400 rpm



Gears are forged alloy steel. Shafts are stressproof steel ground and polished. Clockwise (CW) and counterclockwise (CCW) notations indicate direction of shaft rotation when facing outer end of shaft. All shaft arrangements will operate opposite direction for that shown. To order specify model number and desired shaft arrangement.

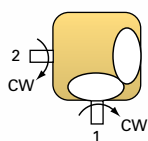

TYPE B

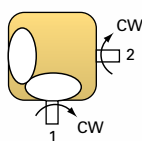

TYPE C

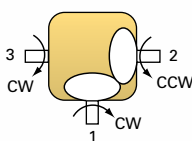

TYPE D

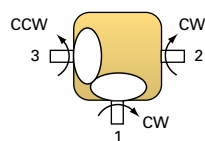

TYPE E

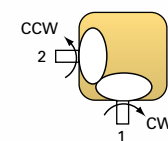

TYPE F

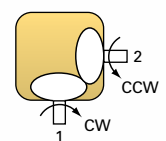

TYPE G

GB210, GB210S, GB210S-R2

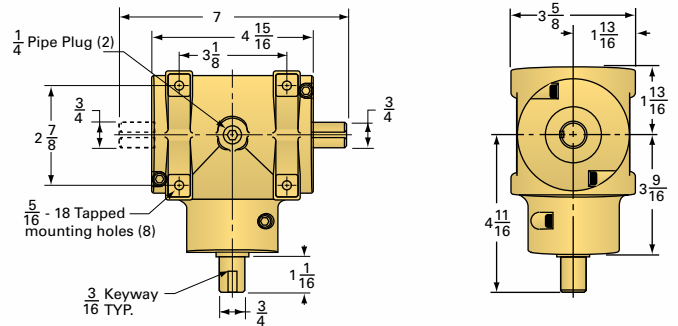

GB15

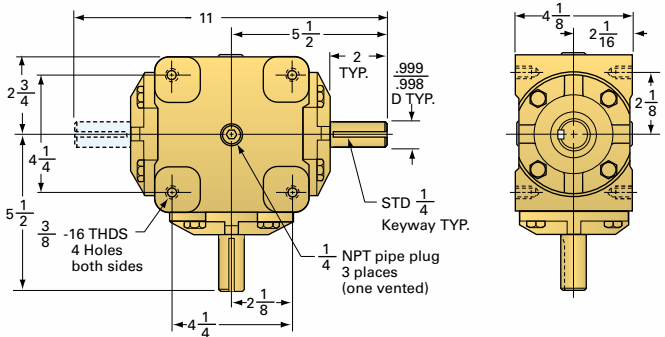

GB12

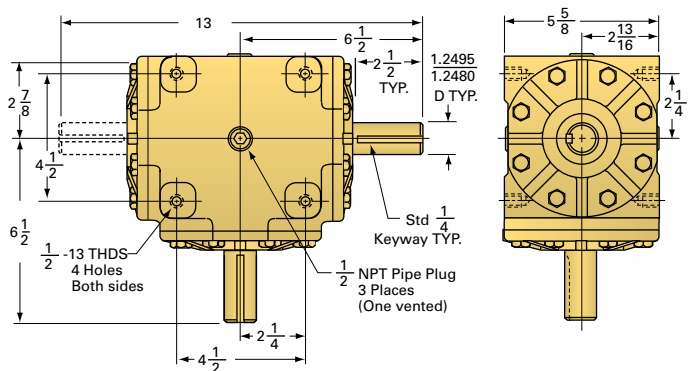

GB210, GB210S, and GB210S-R2 are filled with EP-90 Gear lubricant at time of shipment. GB15 and GB12 are shipped dry. Fill with EP-90 Gear Lubricant: Capacity 1 qt.

LINKJAC™ SHAFTING

ActionJac™ LinkJac™ Line Shafting is used to interconnect the input shafts of ActionJac™ Worm Gear Screw Jacks used in a multiple arrangement. The shafts transfer the torque from the motor to the jack or from jack to jack. LinkJac™ is available in either steel Line Shafting available in standard lengths up to 144", or in aluminum Tubular Shafting with bonded journals of stainless steel available in lengths up to 196". Custom end machining and other diameters are available. Contact Nook/Thomson for information.

SELECTION:

There are two major concerns when selecting interconnect shaft:

Critical Speed: How fast will the shaft be turning?

Torsional Twist: How much torque will the shafts be transmitting?

The two characteristics of a LinkJac™ Line Shaft or Tubular Shafting which can be varied to accommodate these requirements are:

- Length of the shaft
- Diameter of the shaft

When selecting a LinkJac™ Line Shaft or Tubular Shafting, use the largest diameter or shortest length which satisfies both of the following equations.

CRITICAL SPEED

The speed that excites the natural frequency of the screw is referred to as the critical speed.

Since the speed can also be affected by shaft straightness and assembly alignment, it is recommended that the maximum speed be limited to 80% of the calculated critical speed value. The theoretical formula to calculate critical speed in rpm is;

$$N_{\text{Speed}} = .6192 \times \left(\frac{\pi}{L}\right)^2 \times C_s$$

WHERE:

N = Critical Speed in revolutions per minute

L = Length of unsupported shaft in inches

Cs = Value list from table below

Radial support bearings may be needed in order to accommodate the required input rpm. See page 210 - 211 for radial support bearing selection.

LINE SHAFTING

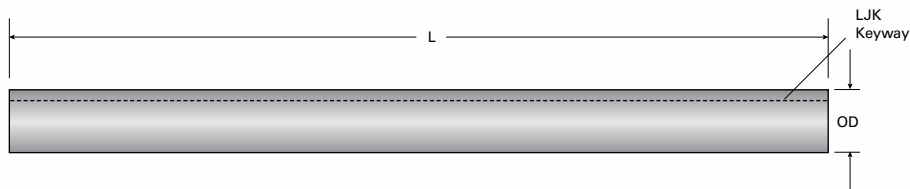

	OD (in)	Keyway (in)	Keyway Length (in)	A	B	Material	C _t	C _s	Weight/in (lb)
LJ-8	.500/.498	-	-	-	-	Steel	1,235	3.895 × 10 ⁵	0.056
LJ-12	.750/.748	-	-	-	-	Steel	6,250	5.851 × 10 ⁵	0.125
LJ-16	1.000/.998	-	-	-	-	Steel	19,500	1.168 × 10 ⁶	0.223
LJ-24	1.500/1.498	-	-	-	-	Steel	95,000	1.169 × 10 ⁶	0.502
LJK-8	.500/.498	1/8 × 1/16	Full Length	-	-	Steel	1,235	3.895 × 10 ⁵	0.056
LJK-12	.750/.748	3/16 × 3/32	Full Length	-	-	Steel	6,250	5.851 × 10 ⁵	0.125
LJK-16	1.000/.998	1/4 × 1/8	Full Length	-	-	Steel	19,500	1.168 × 10 ⁶	0.223
LJK-24	1.500/1.498	3/8 × 3/16	Full Length	-	-	Steel	95,000	1.169 × 10 ⁶	0.502

* When adding modified keyways to standard LinkJac™ shafting, please contact Nook/Thomson Engineering.

TORSIONAL TWIST

The degree of twist experienced by LinkJac™ Line Shaft or Tubular Shafting when a given amount of torque is applied. To insure proper synchronization of ActionJac™ motion, it is recommended not to exceed 1° of twist. The theoretical formula to calculate torsional twist in degrees is;

$$N_{\text{Twist}} = T \times \frac{L}{C_t}$$

WHERE:

N = Torsional Twist in degrees

L = Length of shaft in inches

C_t = Value list from table below

T = Torque

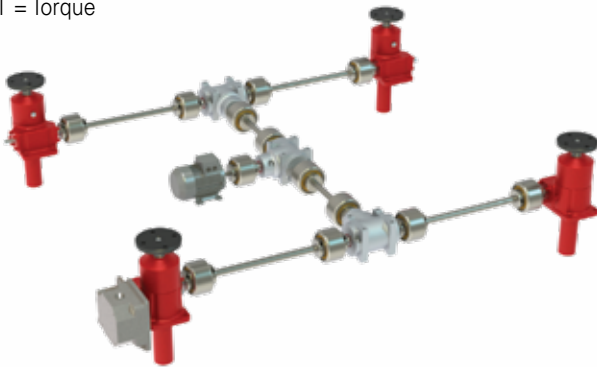

DESIGN INFORMATION

The length used in the previously listed formulas is the unsupported length of the shaft. If support bearings are used on the shaft, the length is the longest unsupported length between bearings.

The previously listed formulas give a theoretical value of critical speed and torsional twist. Alignment, straightness and stiffness of the system all contribute to determining the actual value.

The torque in the system is also limited by the torque capacity of the coupling.

Allow appropriate spacing between the jack input shaft and the LinkJac™ Line Shaft or Tubular Shafting inside the coupling.

For some combinations of couplings and jacks, the radius of the suggested coupling is larger than the distance from the center of the worm shaft to the base.

Nook/Thomson offers a range of couplings for use with LinkJac™ Line Shaft or Tubular Shafting and ActionJac™ products in both floating shaft and supported shaft applications. See pages 190-191 for more information.

METRIC TUBULAR SHAFTING

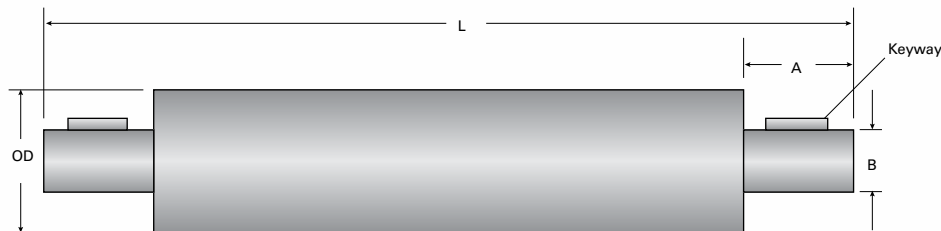

Metric Tubing	OD (in [mm])	Keyway (mm)	Keyway Length (mm)	A (mm)	B (mm)	Material	C _t	C _s	Weight/in (lb)
LJT-27	27 _{k13} [1.06]	5 × 2.5	28	35	14 _{h7}	Aluminium	3,375	9.798 × 10 ⁵	0.035
LJT-40	40 _{k13} [1.57]	6 × 3	40	45	18 _{h7}	Aluminium	12,250	1.504 × 10 ⁶	0.055
LJT-50	50 _{k13} [1.99]	6 × 3	40	55	22 _{h7}	Aluminium	25,000	1.907 × 10 ⁶	0.069
LJT-60	60 _{k13} [2.36]	8 × 3.5	50	55	30 _{h7}	Aluminium	43,750	2.312 × 10 ⁶	0.084

FLEXIBLE COUPLINGS

Jacks used alone or in multiple arrangements require couplings to transmit power to the input shaft. Nook/Thomson provides jaw type and flex type couplings for use with jacks. The selection process for couplings includes the following steps:

- 1) Refer to the jack specification tables to determine torque requirements per jack for your application.
- 2) Determine total coupling capacity required by multiplying the torque required per jack by the number of jacks to be driven by the coupling.
- 3) Check the torque required against maximum torque rating as shown in the table. Select a coupling with a maximum torque greater than the application torque.
- 4) If using flex type couplings, full-flex couplings should be used for close coupled arrangements. For floating shaft applications, use two

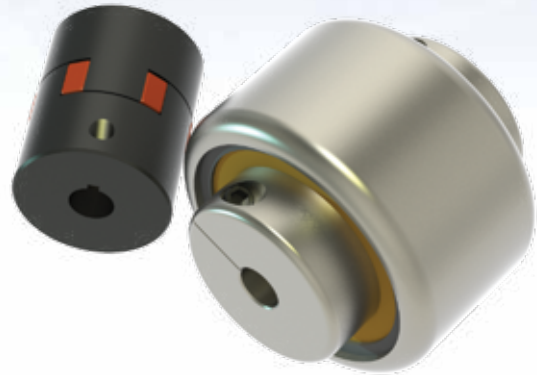

Flex-Rigid couplings. The rigid half should be mounted on the floating shaft.

All jacks, shafts, couplings and motor should be carefully aligned for maximum performance. Couplings with bores other than those specified are available upon request.

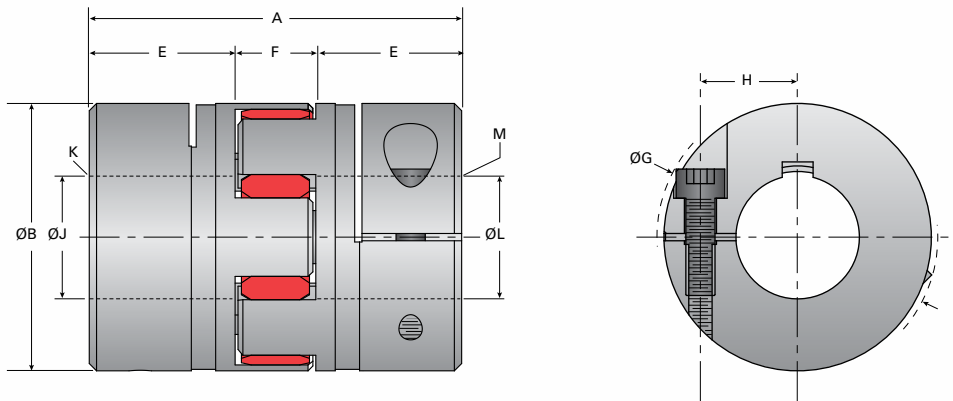

JAWTYPE SERIES

Product Code	Max. Torque Rating (in-lb)	Approx. Wt. (lb)	Clamp Bolt Torque (in-lb)	Coupling Dimensions (in)						Bore Sizes (in)			
				A	B	E	F	G	H	J	Keyway K	L	Keyway M
C-3020-01	111	0.10	12	1.38	1.18	0.43	0.51	1.27	0.45	0.375	1/8 x 1/16	0.375	1/8 x 1/16
C-3025-01	150	0.30	93	2.60	1.57	0.98	0.63	1.81	0.57	0.500	1/8 x 1/16	0.500	1/8 x 1/16
C-3025-05	150	0.30	93	2.60	1.57	0.98	0.63	1.81	0.57	0.500	1/8 x 1/16	0.625	3/16 x 3/32
C-3025-02	150	0.30	93	2.60	1.57	0.98	0.63	1.81	0.57	0.500	1/8 x 1/16	0.750	3/16 x 3/32
C-3025-03	150	0.30	93	2.60	1.57	0.98	0.63	1.81	0.57	0.625	3/16 x 3/32	0.625	3/16 x 3/32
C-3025-04	150	0.30	93	2.60	1.57	0.98	0.63	1.81	0.57	0.625	3/16 x 3/32	0.750	3/16 x 3/32
C-3025-06	150	0.30	93	2.60	1.57	0.98	0.63	1.81	0.57	0.750	3/16 x 3/32	0.750	3/16 x 3/32
C-3030-01	531	0.62	93	3.07	2.17	1.18	0.71	2.26	0.79	0.750	3/16 x 3/32	1.000	1/4 x 1/8
C-3030-02	531	0.62	93	3.07	2.17	1.18	0.71	2.26	0.79	1.000	1/4 x 1/8	1.000	1/4 x 1/8

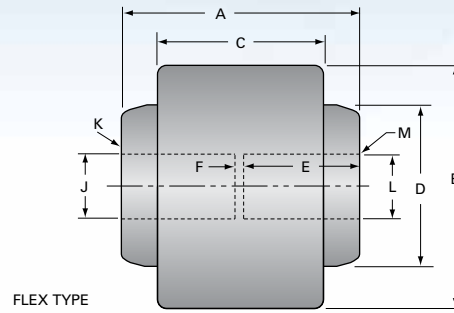

HEAVY DUTY SERIES

Product Code		Max. Torque Rating (in-lb)	Approx. Wt. (lb)	Coupling Dimensions (in)						Bore Sizes (in)			
Full Flex	Flex-Rigid			A	B	C	D	E	F	J	Keyway K	L	Keyway M
C-1800-04	C-1805-04	2,500	5	3.125	3.31	2.00	2.00	1.50	0.125	.4995 .4990	1/8 x 1/16	.7495 .7490	3/16 x 3/32
C-1800-01	C-1805-01	2,500	5	3.125	3.31	2.00	2.00	1.50	0.125	.4995 .4990	1/8 x 1/16	.9995 .9990	1/4 x 1/8
C-1800-05	C-1805-05	2,500	5	3.125	3.31	2.00	2.00	1.50	0.125	.7495 .7490	3/16 x 3/32	.7495 .7490	3/16 x 3/32
C-1800-02	C-1805-02	2,500	5	3.125	3.31	2.00	2.00	1.50	0.125	.7495 .7490	3/16 x 3/32	.9995 .9990	1/4 x 1/8
C-1800-03	C-1805-03	2,500	5	3.125	3.31	2.00	2.00	1.50	0.125	.9995 .9990	1/4 x 1/8	.9995 .9990	1/4 x 1/8
C-1810-01	C-1815-01	7,500	8	3.75	3.75	2.53	2.375	1.82	0.125	1.2495 1.2490	1/4 x 1/8	1.2495 1.2490	1/4 x 1/8
C-1810-02	C-1815-02	7,500	8	3.75	3.75	2.53	2.375	1.82	0.125	1.3745 1.3740	5/16 x 5/32	1.2495 1.2490	1/4 x 1/8
C-1810-03	C-1815-03	7,500	8	3.75	3.75	2.53	2.375	1.82	0.125	1.4995 1.4990	3/8 x 3/16	1.2495 1.2490	1/4 x 1/8

* To maximize life, it is recommended that gears be lubricated at installation.

ECONOMY SERIES

Product Code		Max. Torque Rating (in-lb)	Approx. Wt. (lb)	Coupling Dimensions (in)						Bore Sizes (in)			
Full Flex	Flex-Rigid			A	B	C	D	E	F	J	Keyway K	L	Keyway M
P-2200-288	-	210	0.37	2.13	1.89	1.46	1.26	0.98	0.16	0.500	1/8 x 1/16	0.500	1/8 x 1/16
P-2200-185	-	210	0.37	2.13	1.89	1.46	1.26	0.98	0.16	0.500	1/8 x 1/16	0.750	3/16 x 3/32
P-2200-193	-	210	0.37	2.13	1.89	1.46	1.26	0.98	0.16	0.625	3/16 x 3/32	0.750	3/16 x 3/32
P-2200-196	-	260	0.71	2.2	2.05	1.61	1.42	1.02	0.16	0.625	3/16 x 3/32	0.750	3/16 x 3/32
P-2200-178	-	210	0.37	2.13	1.89	1.46	1.26	0.98	0.16	0.750	3/16 x 3/32	0.750	3/16 x 3/32
P-2200-182	-	260	0.71	2.2	2.05	1.61	1.42	1.02	0.16	0.750	3/16 x 3/32	0.750	3/16 x 3/32
P-2200-183	-	610	1.64	3.31	2.6	1.81	1.73	1.57	0.16	0.750	3/16 x 3/32	1.000	1/4 x 1/8
P-2200-191	-	610	1.64	3.31	2.6	1.81	1.73	1.57	0.16	0.750	3/16 x 3/32	1.125	1/4 x 1/8
P-2200-177	-	1,170	3.31	3.46	3.62	1.97	2.56	1.46	0.55	1.000	1/4 x 1/8	1.000	1/4 x 1/8

ENVIRONMENTAL JACK OPTIONS

ActionJac are ruggedly designed for most industrial applications. The standard jack is capable of withstanding ambient temperatures ranging from 0°F to 180°F.

Nook/Thomson offers several options for demanding applications. Application such as; Indoor-wet/harsh, indoor wet/food grade, outdoor, marine, and high-temp (180°F to 300°F).

HOW TO ORDER ENVIRONMENTAL JACKS

Example:

2.5-MSJ-U 6:1/SSE-1/SSE-2/FT/24/ **IWH** S
 Product Code

PRODUCT CODE	Environment
IWH	Indoor - Wet/Harsh
IWF	Indoor - Wet/Food Grade
OUT	Outdoor
MAR	Marine
HTX	High Temp
LTX	Low Temp

INDOOR - WET/HARSH ENVIRONMENT

Intended for basic wash down with harsh cleaning chemicals.

Change includes:

- Stainless Steel Fasteners and Hardware
- Fluorocarbon (Viton) Seals
- Corrosion Resistant Motor Adapters and Reducers
- Corrosion Resistant Limit Switches
- Hypalon Coated Nylon Boot
- Self-Priming Epoxy Paint



INDOOR - WET/FOOD GRADE ENVIRONMENT

Intended for food processing application.

Change includes:

- Stainless Steel Fasteners and Hardware
- Fluorocarbon (Viton) Seals
- Corrosion Resistant Motor Adapters and Reducers
- Corrosion Resistant Limit Switches
- Hypalon Coated Nylon Boot
- Self-Priming Epoxy Paint
- Food Grade Grease



OUTDOOR

Intended for basic outdoor and weather environments.

Change includes:

- Stainless Steel Fasteners and Hardware
- Fluorocarbon (Viton) Seals
- Corrosion Resistant Motor Adapters and Reducers
- Corrosion Resistant Limit Switches
- Hypalon Coated Nylon Boot
- Self-Priming Epoxy Paint as Primer
- Polyurethane Outdoor Coating for Topcoat



MARINE

Intended for salt air outdoor and weather environments.

Change includes:

- Stainless Steel Fasteners and Hardware
- Fluorocarbon (Viton) Seals
- Corrosion Resistant Motor Adapters and Reducers
- Corrosion Resistant Limit Switches
- Hypalon Coated Nylon Boot
- Self-Priming Epoxy Paint as Primer
- Marine Polysiloxane Outdoor Coating for Topcoat



HIGH-TEMP (180°F TO 300°F)

Intended for indoor high ambient temperature environments.

Change includes:

- Grease Mobiltemp SHC32
- Fluorocarbon (Viton) Seals
- Silicone Coated Fiberglass Boot (max 550 deg F).
- Tempercoate H20 Primer
- Tempercote H20 (Color: Med. Gray) for Topcoat

NOTE: High-Temp Cylinders do not accommodate Motor Mounts, Limit Switches, and non- standard RAD Gearboxes.



LOW-TEMP (-40°F TO 0°F)

Intended for outdoor low ambient temperature environments.

Change includes:

- Stainless Steel Fasteners and Hardware
- Grease Aeroshell #22
- Fluorocarbon (Viton) Seals
- Hypalon Coated Nylon Boot
- Self-Priming Epoxy Paint as Primer
- Polyurethane Outdoor Coating for Topcoat

NOTE: Low-Temp Cylinders do not accommodate Limit Switches and non- standard RAD Gearboxes.



ROTARY LIMIT SWITCH

Every motorized Worm Gear Screw Jack must be controlled so that power to the motor is turned off and the brake engaged before the limits of mechanical travel are reached. The ActionJac™ rotary limit switch senses extension shaft rotation and provides switch contact closures that can be used to control motors.

This sturdy, durable assembly is available with two or four circuits or two circuits and a potentiometer. Each circuit has a separate rotating cam that actuates a high quality switch. The switch actuation may be individually and infinitely adjusted anywhere within the travel of the jack.

These assemblies contain gear reducers with ratios that vary according to the model and travel of the jack. Nook/Thomson selects ratios that result in maximum cam rotation for best accuracy, repeatability and minimum hysteresis. In most cases, with full travel of the actuator, the cam will rotate 3/8 to 7/8 of a revolution to actuate a switch. In the event that the cam continues to rotate, the switch returns to its original state after approximately 25° of rotation, with no damage to the limit switch assembly.

The 2-circuit switch assembly is useful for limiting the maximum and minimum extension. The 4-circuit assembly gives the possibility of additional signals for other user purposes. The potentiometer version is used to provide an analog signal for sensing jack position. Single Pole Double Throw (SPDT) switches are standard and Double Pole Double Throw (DPDT) switches are optional. These assemblies are dust protected and meet NEMA 4 and 5 standards for oil and water tightness.

The ActionJac™ rotary limit switch assembly is mounted to the extension shaft side of the ActionJac™ Worm Gear Screw Jack opposite the input.

The rotary limit switch is available for ActionJac™ Worm Gear Screw Jack sizes 2 tons and larger. Most jack models have close and extended mounts to provide clearance around the switch housing. See the following chart for dimensions.

Switches are factory installed to assure proper assembly in the correct orientation for the specified mounting position.

Product Code	Number of Circuits	Switch Type	Potentiometer
2CA	2	SPDT	no
2CC	2	DPDT	no
4CA	4	SPDT	no
4CE	4	DPDT	no
PTA	2	SPDT	yes
PTC	2	DPDT	yes

HOW TO ORDER A ROTARY LIMIT SWITCH

SPECIFY:

- Product code (see table in the left column)
- Mounting Position (1 through 8)
- Close or Extended Mount (C or E)

Insert the correct designation in the ActionJac™ Worm Gear Screw Jack reference number (see page 31 and 69 for more information on jack reference numbers).

EXAMPLE:

2.5-MSJ-U 6:1 / SSE-1 / **2CA-4E** / FT / 24.5 / S

Extension Shaft Designation  Position

Examples of rotary limit switch designations:

2CA-4C – Rotary Limit Switch, 2-circuit, SPDT, position 4, close mount

4CE-1E – Rotary Limit Switch, 4-circuit, DPDT, position 1, extended mount

C = Close mount on

E = Extended mount (see following page)

IMPORTANT: These designation numbers are not complete part numbers. These assemblies contain gear reducers with ratios that vary according to the model and travel of the jack. If you are ordering a replacement switch assembly, complete information on the jack is required.



CAUTION: Limit switches are not adjusted at the factory. Switches should be set during installation.

Instructions for setting the limit switch is available online at www.nookindustries.com.

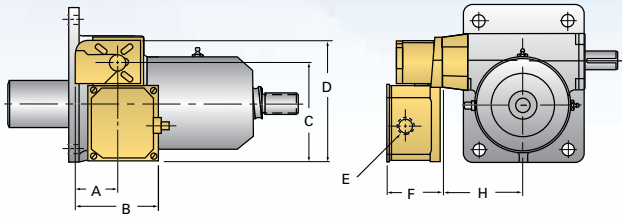

Dimensions (in)

CIRCUITS	A	B	C	D	E	F
LS-2C 2 CIRCUIT	2.46	5.25	6.24	7.62	¾-NPT	3.25
LS-4C 4 CIRCUIT	2.46	5.25	8.24	9.62	1-NPT	3.88
LS-2PT 2 CIRCUIT W/ POTENTIOMETER	2.46	5.25	8.24	9.62	1-NPT	3.88

Model	Dim. H Close Mount (in)	Dim. H Ext. Mount (in)	Close Mount Positions	Extended Mount Positions
2-BSJ & MSJ	N/A	3.56	-	All
2R, 2.5-BSJ & MSJ	2.75	3.56	All	All
3-BSJ	N/A	3.56	-	All
5-BSJ & MSJ	3.56	4.56	All	All
10, 15-BSJ & MSJ	3.88	5.56	All	All
20-BSJ & MSJ	4.41	5.81	All	All
30, 35-MSJ	5.25	7.06	All	All
50-BSJ & MSJ	6.25	11.06	1,2,4,7	All
75-BSJ & MSJ	7.25	12.06	All	All
100-BSJ & MSJ	8.25	12	1,2,4,7	All

ROTARY LIMIT SWITCH POSITIONS

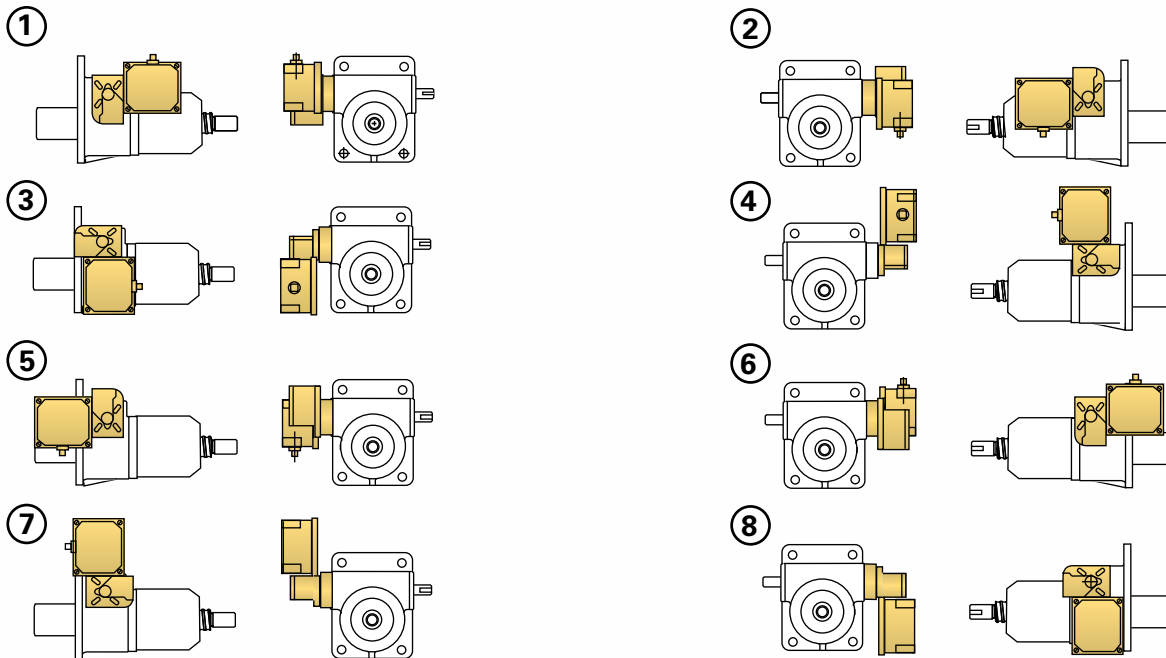

ELECTRICAL RATINGS:

SWITCHES:

DC Current — 115 Volts SPDT, 0.50 amps
 DPDT, 0.125 amps — Make or Break
 Continuous 10 amp

AC Current — 115 Volts SPDT, 15 amps
 DPDT, 10 amps

10-TURN POTENTIOMETER:

0-500 OHM, 2 Watt

NOTE: While the 10-turn potentiometer is rated for 0-500 Ohms, as implemented in the rotary limit switch assembly, it can not and should not operate over its full range. Minimum and maximum resistance values can not be known until the unit is installed and final travel limit adjustments have been made, therefore, the device connected to the potentiometer should include provisions for trimming to compensate for these values.

WIRING DIAGRAMS:

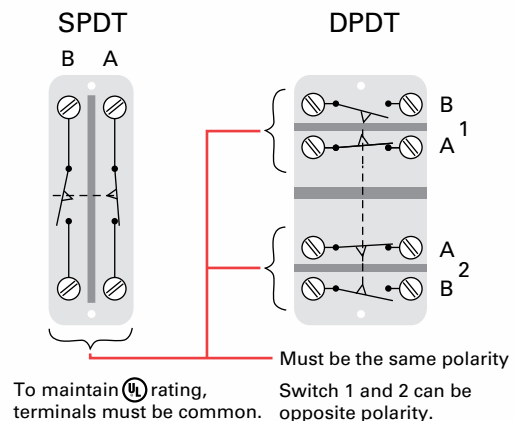

NOOK/THOMSON SENSOR SYSTEM™ (NSS) PATENT PENDING

The Nook/Thomson Sensor System (NSS) is designed to meet the need for low cost position sensing on worm-gear screw jacks. It is highly accurate, with repeatability up to $\pm .004"$ (0.1MM). The patented design allows users to install and adjust sensors on a single screw jack and integrate easily with a motion control system. Since there is zero maintenance, the Nook/Thomson Sensor System helps control screw jack systems in ways that have never before been possible.

The sensor system is supplied with two PNP or NPN (normally closed) switches. For additional switches or to order a normally open switch, contact Nook/Thomson Application Engineers.

HOW TO ORDER THE NOOK/THOMSON SENSOR SYSTEM™

EXAMPLE: 2.5-MSJ-U 6:1 / SSE-1 / SSE-2 / FT / 8 / PS

Product Code 
 P = PNP
 N = NPN

The NSS is designed to allow easy field adjustments. Two magnets are secured to the end of the lift shaft to ensure a positive response once it passes near the position sensor. To adjust the position sensors simply position the lift shaft in the correct position, loosen the locking screw, and then slide the movable sensor to the desired location until the sensor indicates a response. The NSS is supplied with three slots in the stem cover, and two position sensors. Additional sensors can be added or moved to any of the three slots. It is also possible to add multiple sensors to the same slot.

MAX OPERATING SPEED WHEN USING THE NOOK/THOMSON SENSOR SYSTEM IS 60 IN/MIN



Nook/Thomson worm gear screw jacks are used widely in the commercial food industry.

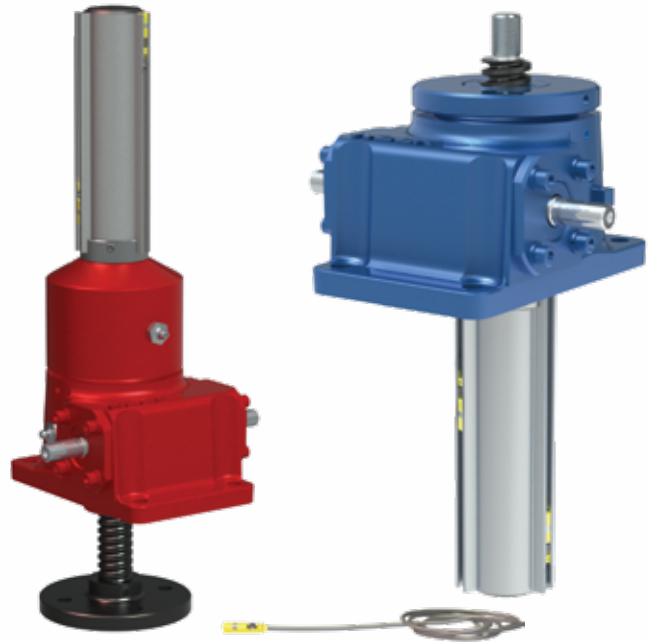

PROXIMITY SENSORS

24Vdc - PNP Or NPN, N.C., Three Wires: +V, 0V, and Signal



Inch Jack Models	A (in)	B (in)	Sensor Bandwidth (in)
05-BSJ and all MINI JACKS	2.83	1.88	.33
1-BSJ and 1-MSJ	2.83	1.88	.33
2-BSJ and 2-MSJ	2.83	2.25	.33
2.5-BSJ and 2.5-MSJ	2.83	2.25	.33
5-MSJ	3.19	3.38	.5
5-BSJ-I and 5HL-BSJ-I	3.19	3.38	.5
5-BSJ-U and 5HL-BSJ-U	3.56	3.38	.5
10-MSJ	3.83	3.38	.5

Metric Jack Models	A (mm)	B (mm)	Sensor Bandwidth (mm)
EM05-BSJ and EM05-MSJ	72	48	8
EM1-BSJ and EM1-MSJ	72	48	8
EM2.5-BSJ and EM2.5-MSJ	72	57	8
EM5-MSJ	81	86	13
EM5-BSJ-I	81	86	13
EM5-BSJ-U	90	86	13
EM10-MSJ	90	86	13

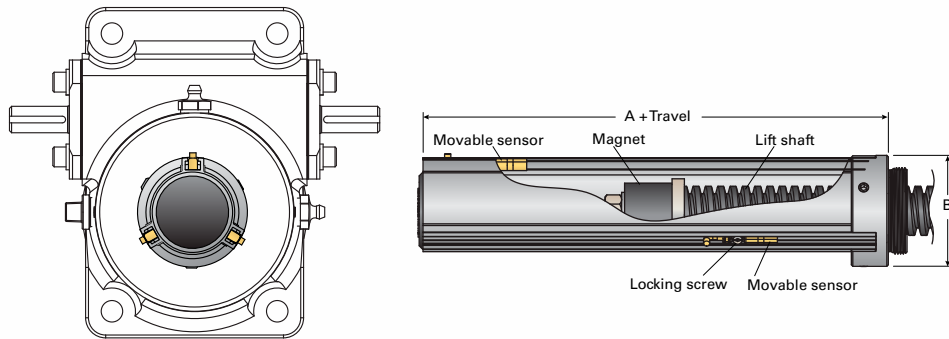

Nook/Thomson worm gear screw jacks used in a conveyor application.

IN-LINE ENCODER

IN-LINE ENCODER IS INSTALLED BETWEEN THE MOTOR ADAPTER AND MOTOR.

For precise position sensing at the input shaft, an ActionJac™ in-line encoder option may be factory installed between the motor and motor adapter or Right-Angle Reducer. This lowcost option requires minimal space, leaving the extension shaft side of the jack free for clearance, for a rotary limit switch, or for coupling to another jack.

The in-line encoder's quadrature output design allows detection of both speed and direction of shaft rotation.

The ActionJac™ in-line encoder option requires an optional motor mount or Right-Angle Reducer..

- Sensing speed range: 0 -10,000 rpm
- Pulse output: 60 Pulses per revolution
- Supply voltage: +5 to 24 Volts DC +/-5%
- Supply current: 60 mA typical, 115 mA maximum
- Output drive capability: 250 mA per channel continuous
- Maximum load: 50 ohms per channel

The encoder is face mounted between the motor and motor mount and will offset the length of the motor .61 inches for NEMA 56 and 140 frames and .88 inches for NEMA 180 and 210 frames.

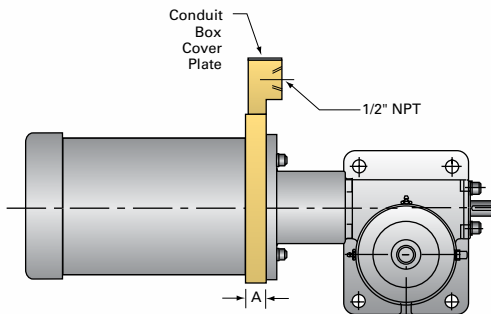
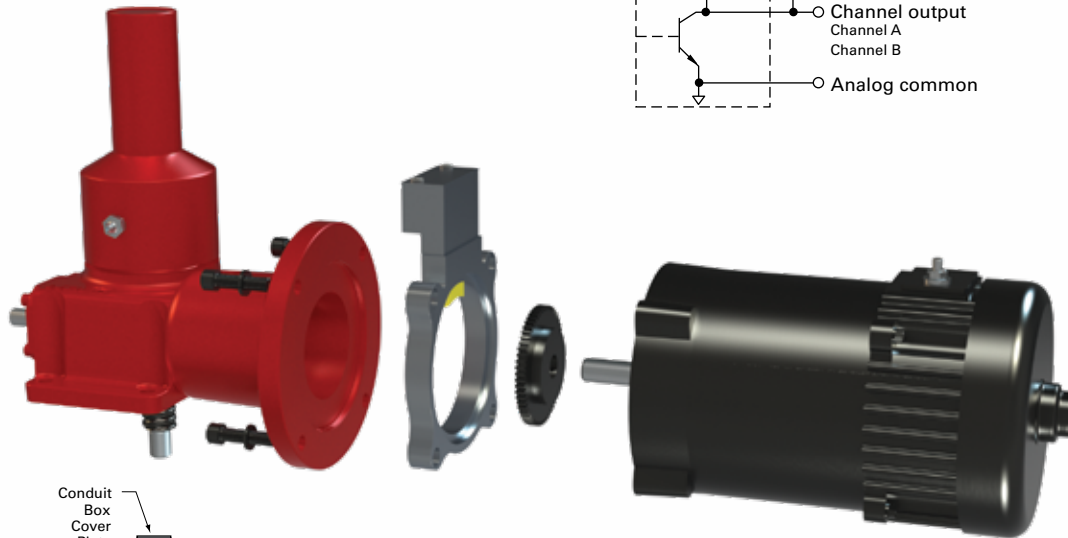

FRAME-SIZE	56C/140TC	180TC/210TC
OFFSET A	.61	.88

ELECTRICAL CONNECTIONS

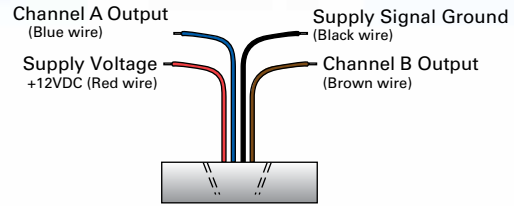

OUTPUT CHANNEL WAVEFORMS

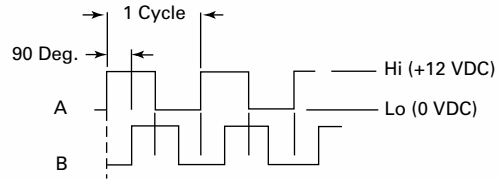

OUTPUT CHANNEL SCHEMATIC (CHANNELS A & B)

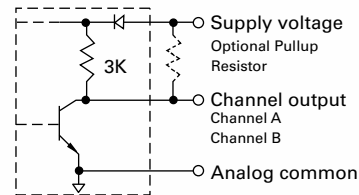

HOW TO ORDER AN IN-LINE ENCODER

Specify the Worm Gear Screw Jack reference number, using the system described on page 31, 69, 103, 123, 141, and 161.

EXAMPLE:

2.5-MSJ-U 6:1 / 10BT-1 / 2CA-4E / FT / 24.5 / ES

Product Code

COUNTERS

For precise position display, a range of digital position indicators are available for use with ActionJac™ Worm Gear Screw Jacks. These indicators measure the rotation of the input shaft and display a corresponding position in a counter window. The display value per input shaft revolution is variable and is achieved through a series of gear reductions configured to accommodate different jack ratios, lift shaft leads and travel distances. Contact Nook/Thomson to determine actual readout scaling available for your application. Not for use with motorized applications. Long travel may result in counter “rolling over.”

SPECIFY:

- Determine Mounting Position
- Count Increase or Decreases with Extension of Shaft

EXAMPLE: 2.5-MSJ-U 6:1 / SSE-1 / **CTI-2** / FT / 24.5 / S
 Extension Shaft Designation

Example of counter designations:

CTI-2 = Counter increasing with extension of lift shaft, position 2
 — Dash number designates mounting position
 — Product code (see table to the right)

CAUTION - Consult Nook/Thomson Engineering when adding a counter. Some jack configurations may have limited travel.



Product Code	Increase or Decrease with extension of travel	Shaft Extension
CEI	Increase	without shaft extension
CED	Decrease	without shaft extension
CTI	Increase	with worm shaft extension
CTD	Decrease	with worm shaft extension
CAI	Increase	with 4" handwheel*
CAD	Decrease	with 4" handwheel*
CBI	Increase	with 6" handwheel*
CBD	Decrease	with 6" handwheel*
CCI	Increase	with 8" handwheel*
CCD	Decrease	with 8" handwheel*
CDI	Increase	with 10" handwheel*
CDD	Decrease	with 10" handwheel*

*See handwheel page 189 to select the correct size for jack model

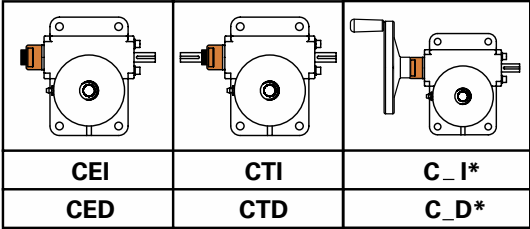

COUNTER POSITIONS

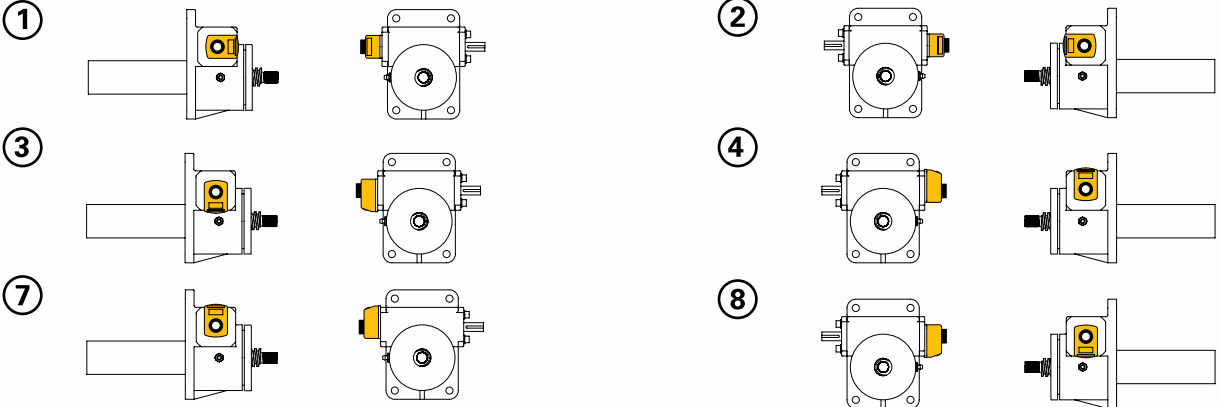

CONTROL PANELS

Nook/Thomson control panels are designed to match the motor when shipped from the factory. The control panels are acceptable to use in most industrial environments (including automotive). Functionality of the control panel can be customized to match any application and spare parts are readily available.

The control panel interconnects with other safety/control systems.

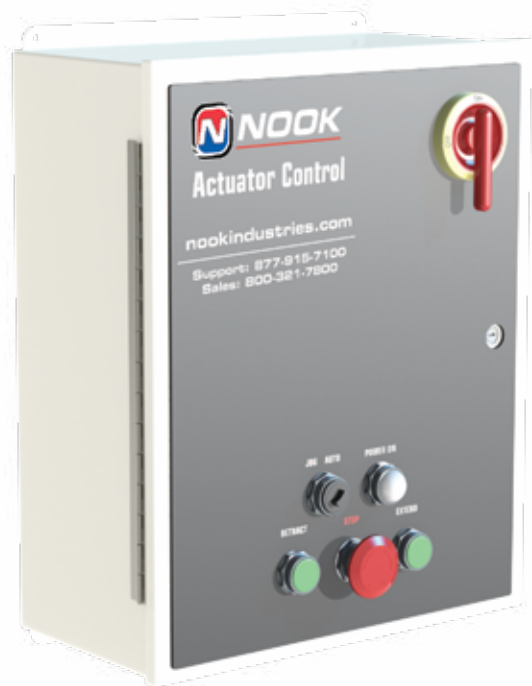

Benefits:

- The control matches the motor with no design time required
- The control is acceptable to use in most industrial environments (including automotive)
- Spare parts are readily available
- Functionality of the control can be customized to match any application
- The control interconnects with other safety/control systems

Motor Capacities:

¼ up to 15 HP 3-phase 230-460-575 VAC induction motors with or without electrically operated brakes.

- NEMA 4/12 Enclosures
- NEMA 4X also available

Internal Wiring:

- Per NFPA-79
- Main fuses with disconnect models
- UL Listed

Limit Switches:

All units include the capacity to work with ActionJac™ limit switches, or custom supplied mechanical limit switches

Front Panel Indicators include Power Indicator

Front Panel Controls include maintained stop push-button; main power disconnect switch (optional); extend push-button; retract push-button, in auto mode, the load moves until limit is reached; in jog mode, the load moves while button is pressed.

CAUTION - Licensed Electrician Required at time of install.

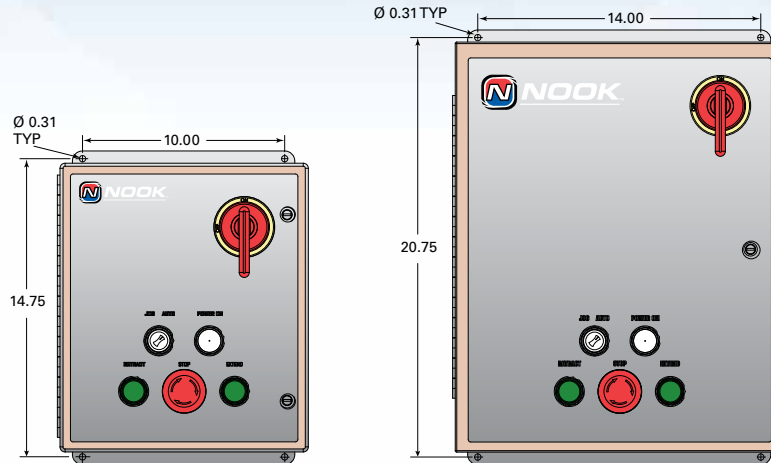

HP	Voltage	3 PH MODEL NUMBERS		Enclosure Size (in) H x W x D
		W/o Disconnect	W/ Disconnect	
¼	230	NCB23025	NCB23025D	14 x 12 x 8
	460	NCB46025	NCB46025D	14 x 12 x 8
½	230	NCB23033	NCB23033D	14 x 12 x 8
	460	NCB46033	NCB46033D	14 x 12 x 8
	575	NCB57033	NCB57033D	14 x 12 x 8
¾	230	NCB23050	NCB23050D	14 x 12 x 8
	460	NCB46050	NCB46050D	14 x 12 x 8
	575	NCB57050	NCB57050D	14 x 12 x 8
1	230	NCB23075	NCB23075D	14 x 12 x 8
	460	NCB46075	NCB46075D	14 x 12 x 8
	575	NCB57075	NCB57075D	14 x 12 x 8
1½	230	NCB230100	NCB230100D	14 x 12 x 8
	460	NCB460100	NCB460100D	14 x 12 x 8
	575	NCB570100	NCB570100D	14 x 12 x 8
2	230	NCB230150	NCB230150D	14 x 12 x 8
	460	NCB460150	NCB460150D	14 x 12 x 8
	575	NCB570150	NCB570150D	14 x 12 x 8
3	230	NCB230200	NCB230200D	14 x 12 x 8
	460	NCB460200	NCB460200D	14 x 12 x 8
	575	NCB570200	NCB570200D	14 x 12 x 8

HP	Voltage	3 PH MODEL NUMBERS		Enclosure Size (in) H x W x D
		W/o Disconnect	W/ Disconnect	
3	230	NCB230300	NCB230300D	14 x 12 x 8
	460	NCB460300	NCB460300D	14 x 12 x 8
	575	NCB570300	NCB570300D	14 x 12 x 8
5	230	NCB230500	NCB230500D	20 x 16 x 8
	460	NCB460500	NCB460500D	14 x 12 x 8
	575	NCB570500	NCB570500D	14 x 12 x 8
7½	230	NCB230750	NCB230750D	20 x 16 x 8
	460	NCB460750	NCB460750D	20 x 16 x 8
	575	NCB570750	NCB570750D	20 x 16 x 8
10	230	NCB231000	NCB231000D	20 x 16 x 8
	460	NCB461000	NCB461000D	20 x 16 x 8
	575	NCB571000	NCB571000D	20 x 16 x 8
15	230	NCB231500	NCB231500D	20 x 16 x 8
	460	NCB461500	NCB461500D	20 x 16 x 8
	575	NCB571500	NCB571500D	20 x 16 x 8

TRUNNION ADAPTERS



Nook/Thomson ActionJac™ Trunnion adapter plates allow for easy installation in applications where the jack moves through an arc during operation. These jacks are typically configured with motor mounts or right angle reducers.

Trunnion adapter plates bolt to the jack flange and have precision bores for trunnion pins.

DESIGN INFORMATION

The trunnion pins should be supported to within 1/16 inch of the trunnion adapter plate. See the "A" dimension in the table for the width of the mounting plate. The maximum distance between the trunnion pin support mounting surfaces should be less than or equal to the "A" dimension plus 0.13 inches.

The trunnion pins should be ground to the "D" diameters shown in the table. The trunnion pins should be made from steel with a hardness greater than 30 HRC and a yield strength greater than 60,000 psi.

JACK MODEL	TRUNNION PART NO.	A	B	C	D	E	F	G
2.5-MSJ	TA-0025	6.50	3.88	1.25	0.7491 - 0.7479	1.25	.13	1.750
5-MSJ	TA-0050	8.25	5.75	1.50	0.9991 - 0.9979	1.50	.13	2.188
10-MSJ	TA-0100	9.00	7.25	2.00	1.2488 - 1.2472	1.50	.13	2.600
20-MSJ	TA-0200	11.25	8.00	2.25	1.4988 - 1.4972	1.75	.13	2.875
2.5-BSJ	TA-0025	6.50	3.88	1.25	0.7491 - 0.7479	1.25	.13	1.750
5-BSJ	TA-0050	8.25	5.75	1.50	0.9991 - 0.9979	1.50	.13	2.188
10-BSJ	TA-0100	9.00	7.00	2.00	1.2488 - 1.2472	1.38	.13	2.600
20-BSJ	TA-0200	11.25	8.00	2.25	1.4988 - 1.4972	1.75	.13	2.875

BSJ and MSJ Trunnion Bottom View

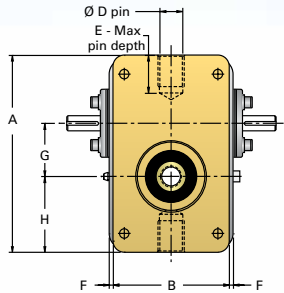

BSJ-U
 (Ball Screw Upright)

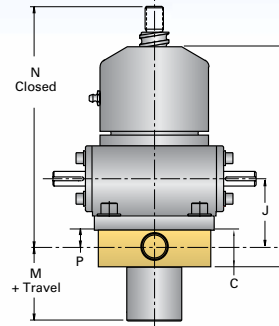

BSJ-I
 (Ball Screw Inverted)

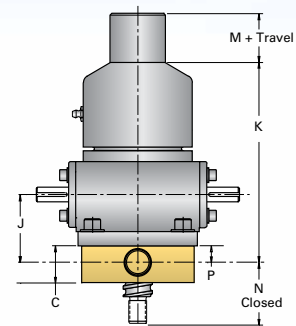

BSJ-UR and MSJ-UR
 (Ball and Machine Screw Upright Rotating)

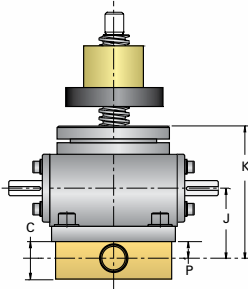

BSJ-IR and MSJ-IR
 (Ball and Machine Screw Inverted Rotating)

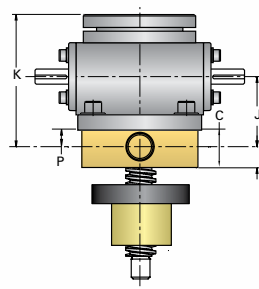

MSJ-U
 (Machine Screw Upright)

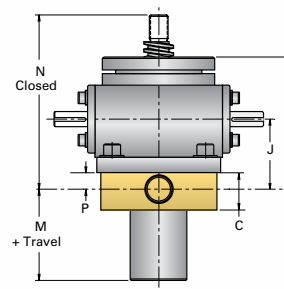

MSJ-I
 (Machine Screw Inverted)

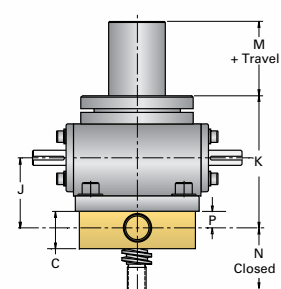

			UPRIGHT			INVERTED			UPRIGHT ROTATING	INVERTED ROTATING
H	J	P	K	M	N	K	M	N	K	K
2.50	2.32	.56	4.38	1.38	5.75	4.38	.69	2.06	4.38	4.38
3.13	2.94	.69	5.44	1.44	7.69	5.44	.63	3.06	5.44	5.44
3.00	3.13	.88	5.75	1.75	7.75	5.75	.63	3.12	5.75	5.75
4.25	4.25	1.00	7.75	1.84	10.25	7.75	.63	3.75	7.75	7.75
2.50	2.32	.56	6.81	2.31	8.19	6.81	1.63	2.06	4.38	4.38
3.13	2.94	.69	10.00	2.31	11.88	10.00	1.75	3.06	5.44	5.44
3.00	3.13	.88	10.00	2.75	12.25	10.00	1.63	3.37	5.75	5.75
4.25	4.25	1.00	15.75	3.63	18.25	15.7	2.38	3.75	7.75	7.75



BELLOWS BOOTS

STANDARD AND SPECIAL BELLOWS BOOTS

Bellows boots are available for all sizes and configurations of ActionJac™ Worm Gear Screw Jacks. A boot protects the lifting shaft from contamination and helps retain lubricant to ensure long jack life.

Standard boots are sewn from black neoprene-covered nylon fabric for oil, water and weather resistance and are acceptable for use in -30° to +300°F environments. Optional materials are available for specific operating conditions (see chart).

Guides are recommended for all horizontal applications where travel exceeds 24 inches or if the boot needs to remain centered around the screw. The recommended number of guides is one guide for each 24 inches of travel length.

EXAMPLES: 12 inches of travel = no guides, 24 inches of travel = one guide, 47 inches of travel = one guide, 48 inches of travel = two guides, etc.).

Standard boots are furnished with tie straps for jacks with greater than 65 inches travel. Tie straps are attached from convolution to convolution and help the boot extend uniformly.

SPECIAL END CONFIGURATIONS

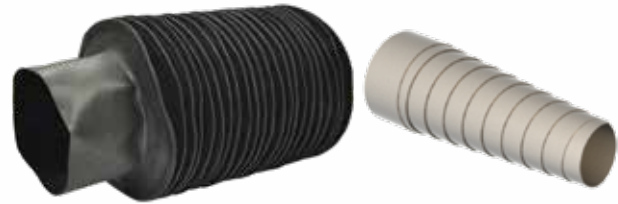
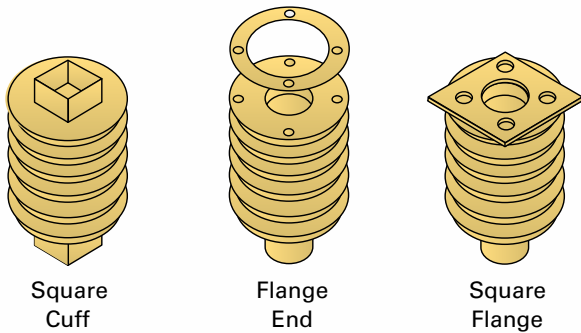

Bellows Boot

Metal cover

SPECIAL BOOT MATERIALS

DESCRIPTION TEMPERATURE	RANGE	APPLICATION COMMENTS
Hypalon-Coated Nylon	-30° TO +300°F	Chemical Resistance, Wash Down
Silicone Coated Fiberglass	-67°F TO +550°F	High Temperature
Aluminum-Coated Fiberglass	-65°F TO +700°F	High Temperature, Hot Chips, Welding Splatter
Metal cover	Contact Nook/ Thomson Engineering for details	Contact Nook/ Thomson Engineering for details

Note: Retracted boot length may increase with some special materials.



Nook/Thomson worm gear screw jacks used in a steel press application.

BELLOWS BOOTS FOR TRANSLATING SCREW JACKS

The end cuff is designed to fit standard end fittings, the top plate and the clevis end. When jack travel is greater than 6 inches, lift screw closed height increases to accommodate the length of the collapsed boot convolutions. For standard boots the increase in closed height is calculated using the formula shown.

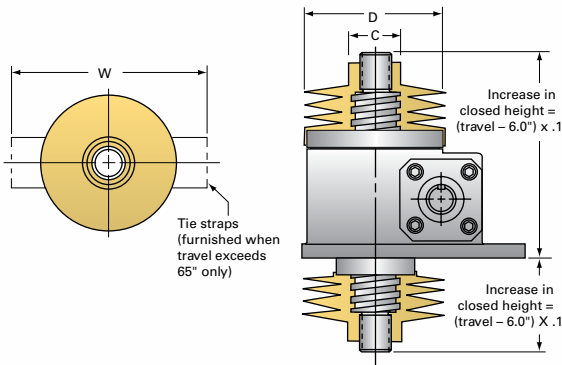

JACK MODEL		C	D	W	Max. Screw Dia (ref.)
Ball Screw	Machine Screw	Dia.	Dia.		
0.5-BSJ	All MJ	1.00*	4.00*	5.50	0.63
1-BSJ	1-MSJ	1.25	4.25	5.75	0.75
2, 2.5 & 3-BSJ	2, 2.5-MSJ	1.50	4.50	6.00	1.16
5, 10-BSJ	5-MSJ	2.00	5.00	6.50	1.50
—	10-MSJ	2.50	5.50	7.00	2.00
—	15-MSJ	2.75	5.75	7.25	2.25
20-BSJ	20-MSJ	3.00	6.00	7.50	2.50
30-BSJ	30-MSJ	4.50	7.50	8.00	3.38
—	35-MSJ	5.00	8.00	9.50	3.75
50,75,100-BSJ	—	6.00	9.00	10.50	4.00
—	50-MSJ	6.50	9.50	11.00	4.50
—	75-MSJ	7.00	10.00	11.50	5.00
—	100-MSJ	8.00	11.00	12.50	6.00

Boot with guide C=1.25 and D= 4.25

HOW TO ORDER BOOTS FOR A TRANSLATING SCREW JACK

Boots may be ordered using the reference number system as shown on pages 31, 69 103, 123, 141, and 161.

For special material boots add "M" to the reference number and add the description.

EXAMPLE:

5-MSJ-U 6:1 / SSE-1 / SSE-2 / FT / 36.0 / BGS
 B = Standard Boot
 G = with Optional Guide(s)

BELLOWS BOOTS FOR ROTATING SCREW JACK

Boots for upright rotating and inverted rotating jacks are ordered as separate line items. Typical rotating jack applications require two boots, one between the housing and the travel nut and one from the travel nut to the end of the lift shaft. Each boot for a rotating screw jack is ordered as a separate line item. To order boots for a rotating screw jack, select the outside diameter D from the chart on the left and specify cuff dimensions and travel per the diagram using the reference number as shown below. Installation arrangements for rotating worm gear screw jacks vary, therefore boots for rotating jacks must be specified by the customer.

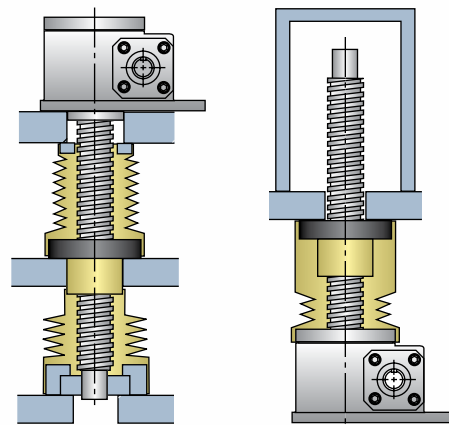

Typical rotating screw jack installations

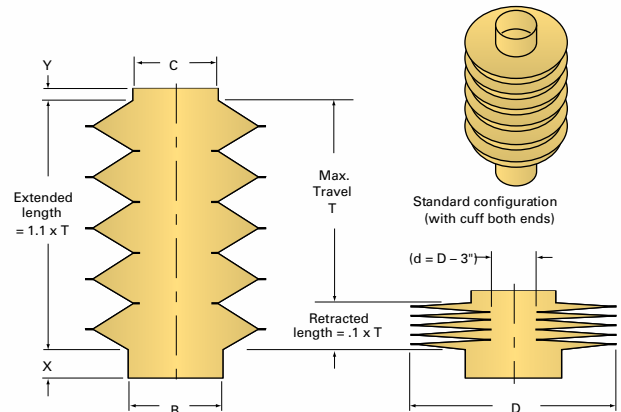

EXAMPLE:

BB / 7.50 / 4.00 x 2.0 / 3.00 x 1.50 / 72.00 / G

Bellocs Boot
 Outside Diameter (D)
 1st Cuff = B x X
 With Guides
 Max. Travel (T)
 2nd Cuff = C x Y

RADIAL SUPPORT BEARINGS

Many applications require longer lift shafts, or jacks that are connected together with a common shaft that is a significant distance apart. Resonance Frequency can cause the lift shaft or link shaft to oscillate and whip, shortening the life of the lift shaft or dislodge the link shafting from its coupling. Radial Support Bearings are used to provide radial support for the lift shaft on rotating style screw jacks, as well as the link shafting products. By adding Radial

Support Bearings, you can increase the effective speed of the lift shaft or link shafting.

There are two styles of Radial support Bearings; Flange Mount and Base Mount. The Flange Mount allows for perpendicular mounting with respect to the axis of rotation. The Base mount allow for in-line mounting with respect to the axis or rotation.

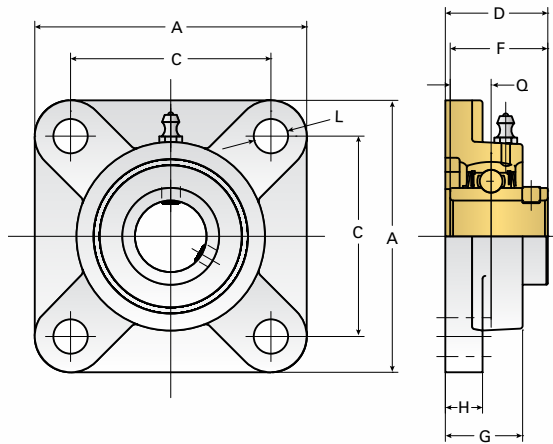

FLANGE MOUNT RADIAL SUPPORT BEARING

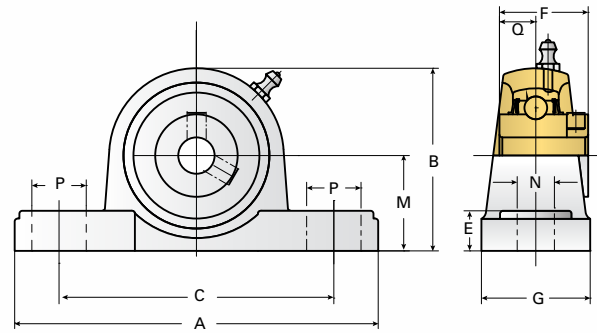

BASE MOUNT RADIAL SUPPORT BEARING

RADIAL SUPPORT BEARING SELECTION TABLE

BASE MOUNT	FLANGE MOUNT	BSJ	MSJ	SS-MSJ	EM-BSJ	EM-MSJ	BEVEL	LINK SHAFT
EZCP201-8	EZCF201-8	1/1HL-BSJ	1-MSJ					LJ/LJK-8
EZCP202-10	EZCF202-10		2/2R/2.5-MSJ	2SS-MSJ				
EZCP204	EZCF204	2.5/2.5HL-BSJ			EM2.5-BSJ		G1	
EZCP204-12	EZCF204-12	2/2R/3-BSJ						LJ/LJK-12
EZCP205	EZCF205	5/5HL/10/10HL-BSJ			EM5-BSJ	EM5-MSJ	G2	
EZCP205-16	EZCF205-16		5-MSJ	5SS-MSJ				LJ/LJK-16
EZCP206	EZCF206				EM10-BSJ	EM10-MSJ		
EZCP206-20	EZCF206-20		10-MSJ	10SS-MSJ				
EZCP208	EZCF208							
EZCP208-24	EZCF208-24		15-MSJ	15SS-MSJ				LJ/LJK-24
EZCP209	EZCF209	20/20HL-BSJ			EM-20-BSJ	EM20-MSJ	G3	
EZCP209-28	EZCF209-28		20-MSJ	20SS-MSJ				
EZCP210	EZCF210							
EZCP212	EZCF212	30/30HL-BSJ						
EZCP212-36	EZCF212-36			25SS-MSJ				
EZCP213-40	EZCF213-40		30-MSJ					
EZCP215-48	EZCF215-48		35-MSJ					



BASE MOUNT RADIAL SUPPORT BEARING

ITEM#	DIA	A	B	C	E	F	G	M	N	P	Q
EZCP201-8	.50"	127	65	95	15	31	38	33.3	13	19	12.7
EZCP202-10	.625"	127	65	95	15	31	38	33.3	13	19	12.7
EZCP204	20mm	127	65	95	15	31	38	33.3	13	19	12.7
EZCP204-12	.75"	127	65	95	15	31	38	33.3	13	19	12.7
EZCP205	25mm	140	70	105	16	34	38	36.6	13	19	14.3
EZCP205-16	1.00"	140	70	105	16	34	38	36.6	13	19	14.3
EZCP206	30mm	165	83	121	18	38.1	48	42.9	17	21	15.9
EZCP206-20	1.25"	165	83	121	18	38.1	48	42.9	17	21	15.9
EZCP208	40mm	184	100	137	19	49.2	54	49.2	17	21	19
EZCP208-24	1.50"	184	100	137	19	49.2	54	49.2	17	21	19
EZCP209	45mm	54	108	146	20	49.2	54	54	17	21	19
EZCP209-28	1.75"	54	108	146	20	49.2	54	54	17	21	19
EZCP210	50mm	206	114	159	22	51.6	60	57.2	20	25	19
EZCP212	60mm	241	138	184	25	65.1	70	69.8	20	25	25.4
EZCP212-36	2.25"	241	138	184	25	65.1	70	69.8	20	25	25.4
EZCP213-40	2.50"	265	150	203	27	65.1	70	76.2	25	30	25.4
EZCP215-48	3.00"	275	163	217	28	77.8	74	82.6	25	30	33.3



FLANGE MOUNT RADIAL SUPPORT BEARING

NOOK NUM.	DIA	A	C	D	F	G	H	L	Q
EZCF201-8	.50"	86	64	33.3	31	25.4	11	12	12.7
EZCF202-10	.625"	86	64	33.3	31	25.4	11	12	12.7
EZCF204	20mm	86	64	33.3	31	25.4	11	12	12.7
EZCF204-12	.75"	86	64	33.3	31	25.4	11	12	12.7
EZCF205	25mm	95	70	35.7	34	27	13	12	14.36
EZCF205-16	1.00"	95	70	35.7	34	27	13	12	14.3
EZCF206	30mm	108	83	40.2	38.1	31	13	12	15.9
EZCF206-20	1.25"	108	83	40.2	38.1	31	13	12	15.9
EZCF208	40mm	130	102	51.2	49.2	36	15	16	19
EZCF208-24	1.50"	130	102	51.2	49.2	36	15	16	19
EZCF209	45mm	137	105	52.2	49.2	38	16	16	19
EZCF209-28	1.75"	137	105	52.2	49.2	38	16	16	19
EZCF210	50mm	143	111	56.6	51.6	40	16	16	19
EZCF212	60mm	175	143	68.7	65.1	48	18	19	25.4
EZCF212-36	2.25"	175	143	68.7	65.1	48	18	19	25.4
EZCF213-40	2.50v	187	149	69.7	65.1	50	22	19	25.4
EZCF215-48	3.00"	200	159	78.5	77.8	56	22	19	33.3

LUBRICANTS

LUBRICATION

ActionJac™ Worm Gear Screw Jacks require lubrication to operate efficiently and with maximum life.

Standard lubrication is NLGI #2 grease. Lubricants are available for both high and low temperature application. If operating conditions exceed 200°F or -20°F, contact Nook/Thomson for alternative lubricants.

The jack gear boxes are shipped pre-greased unless otherwise specified. Before operating any unit, verify lubricant presence. All jack housings are furnished with a grease fitting and pipe plug.

Lubrication inspection is recommended at regular intervals. Once every six months is satisfactory under normal operating conditions, unless experience indicates that regreasing should occur at shorter or longer intervals. Several operating conditions will shorten the lubrication inspection interval.

Lubricants containing additives such as molydisulfide or graphite should not be used.

Ball Screw models need only a light film of lubricant on the lift shaft for most applications. Nook/Thomson E-900 Ball Screw Lubricant may be applied with a cloth or spray. Operating a Ball Screw Jack lift shaft without lubrication will result in a ninety percent reduction in life.

Lubrication intervals for the lift shaft of Machine Screw models are determined by the application. Proper lubrication with E-100 spray lube or PAG-1 grease must be provided to achieve satisfactory service life. It is required that screw assemblies are lubricated often enough to maintain a film of lubricant on the screw.

JACK GEARBOX LUBRICANT

GEAR BOX LUBRICANT	USAGE	NLGI GRADE NUMBER	GELLING AGENT	TEMP. RANGE	NET CONTENTS PER UNIT	PART NO.	NET WEIGHT
GBL-400	Standard applications	2	Lithium	20° F to 280°F	1 tube	NLU-3001	14.1 oz
					Case of 10	NLU-6001	—
GBL-800	High temp applications	1.5	Clay	-50°F to 350°F	1 tube	NLU-3005	12.5 oz
					Case of 10	NLU-6005	—



MACHINE SCREW JACK LIFT SHAFT LUBRICANT

LIFT SHAFT LUBRICANT	USAGE	NLGI GRADE NUMBER	GELLING AGENT	TEMP. RANGE	NET CONTENTS PER UNIT	PART NO.	NET WEIGHT
PAG-1 Grease	Acme Screws and Nuts	2	Calcium	15°F to 400°F	1	NLU-1001	16 oz
					Case of 12	NLU-2001	—
E-100 Spray	Acme Screws and Nuts	2	Calcium	15°F to 400°F	1	NLU-1002	12 oz
					Case of 12	NLU-2002	—



BALL SCREW JACK LIFT SHAFT LUBRICANT

LIFT SHAFT LUBRICANT	USAGE	NLGI GRADE NUMBER	GELLING AGENT	TEMP. RANGE	NET CONTENTS PER UNIT	PART NO.	NET WEIGHT
E-900 Spray	Ball Screws and Nuts	N/A	N/A	-65°F to 350°F	1	NLU-1003	12 oz
					Case of 12	NLU-2003	—
E-900L Oil	Ball Screws and Nuts	N/A	N/A	-65°F to 350°F	1	NLU-1004	32 oz
					Case of 12	NLU-2004	—



NOOK/THOMSON PAINTS

Understanding your environmental condition is critical to any successful application.

To maximize life of any Nook/Thomson products, considering material and paint options is critical. Many of our products can be offered in anti-corrosion material, such as 304 stainless alloys. In addition, Nook/Thomson provides several paint options for a variety of environmental applications.

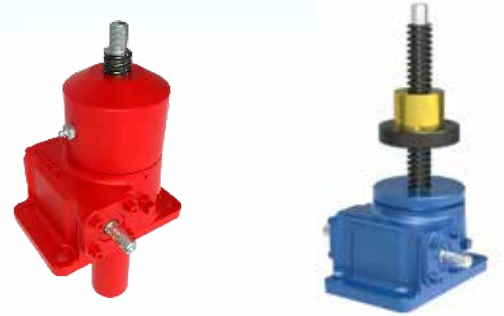

NOOK/THOMSON PAINT OPTIONS

	PART NUM.	ENVIRONMENT CONDITIONS	DRY TIME	CURE TIME	PAINT TYPE	COLOR
STANDARD PAINT	-	Interior, Non-Humid, Clean Conditions Free From Contamination	1 hr.	n/a	Quick Dry Enamel	Red/Blue/White
PREMIUM PAINT – INTERIOR	P-5100-61	Interior, Light Humidity, Heavy Contamination & Dust	2 Days	7 Days	Sherwin-Williams Macropoxy 646	White
PREMIUM PAINT – OUTDOOR	P-5100-72	Exterior, All Weather, UV, Heavy Contamination & Dust	2 Days	7 Days	Sherwin-Williams Acrdon 7300	White
PREMIUM PAINT – MARINE	P-5100-75	Exterior, Saltwater Humidity, All Weather, UV, Heavy Contamination & Dust	2 Days	7 Days	Sherwin-Williams Sher-Loxane 800	White

NOOK/THOMSON PAINT SPRAY CANS

ActionJac™ Worm Gear Screw Jacks are painted with a unique enamel color blend that is specific to Nook/Thomson. Nook/Thomson can provide alternative colors and epoxy paints upon request, including specific mil spec paints.

Nook/Thomson paints are available in 9 oz. aerosol cans in three different colors:

- Blue P-5100-25
- Red P-5100-26
- White P-5100-27



INSTALLATION & MAINTENANCE

INSTALLATION

Alignment of the jack (or jacks) directly affects service life. Jacks must be properly aligned in all planes so that the main drive shaft can be turned without evidence of binding. The following steps are suggested but may not always be applicable when installing jacks. It is the responsibility of the end user to determine specific installation procedures.

- 1) The mounting flange of the jack is a precision-machined surface. The worm shaft and lift shaft bearing bores are machined in tight relationship to the mounting flange.

Better mounting surfaces will make it easier to align the jack to the load.

The surface(s) to which the jacks are mounted should be flat, smooth and perpendicular to the guides. Note: for rotating worm gear screw jacks, also ensure that the lift shaft is parallel to the guides.

- 2) Start with the load temporarily supported in a position closest to the jack housing(s). Locate the jack by putting the jack in place with the fasteners loosely assembled.
- 3) Level the jacks if necessary. For some applications, a piece of compliant material such as the rubber used for machine isolation bases will help compensate for potential misalignment.
- 4) Check the level of the load, then, actuate the jacks bringing the lift shaft or travel nut nearly in contact with the load. Adjust the position of the jacks so that the jack attachment points are centered on the load mounting points. Tighten the jack mounting screws. If a compliant material is installed, make sure that the fasteners do not compress the material and that there is clearance around the fasteners.

- 5) Rotate the worms to adjust the timing of the lift shafts as necessary to equally distribute the load. Assemble the load mounting hardware and tighten.

- 6) Cycle the jacks from closest to farthest point. For rotating jacks with a lift shaft bearing support, loosen the bearing support fasteners and re-tighten to ensure that the lift shaft is parallel to the guide system.

Failure to do this could result in lift shaft stress fracture.

- 7) Cycle the jacks again and verify that no binding occurs.

Check the lubrication levels, check the limit switch settings (note: rotary limit switches are not factory set), check the tightness of all fasteners and put the jacks in service.

MAINTENANCE

ActionJac™ Worm Gear Screw Jacks require minimum maintenance. In addition to maintaining lubrication levels in the gearbox, the following items should be checked: Lifting screws must be kept free of contaminants and should be lubricated. Refer to the lubrication section on page 212 for appropriate lubrications. If possible, screws should be booted or returned to retracted position when not in use.

For Machine Screw Jacks, lash between the lift shaft and travel nut (or drive sleeve) greater than 1/4 the screw pitch indicates the need for replacement of the jack lift shaft drive components.

For Ball Screw Jacks, the ball screw should be checked periodically for spalling of the raceway. In normal operation, ball screw lash does not change significantly over the life of the ball screw.

For all jacks, check the backlash between the worm and worm gear. Lash in excess of 30° for ratios 5:1 to 8:1 and 60° for ratios 20:1 and 32:1 indicates the need to replace the worm and worm gear.



Nook/Thomson worm gear screw jacks are used widely in the manufacturing industry.

UNIT CONVERSION CHART

ENGLISH TO METRIC		METRIC TO ENGLISH	
Length	Torque	Length	Torque
1 ft = 304.8 mm	1 ft-lb = .001356 kN-m	1 mm = .00328 ft	1 kN-m = 737.3 ft-lb
1 ft = .3048 m	1 ft-lb = 1.356 N-m	1 m = 3.28 ft	1 N-m = .737 ft-lb
1 ft = .0003048 km	1 ft-lb = 135.6 N-cm	1 km = 3821 ft	1 N-cm = .00737 ft-lb
1 in = 25400 μm	1 ft-lb = 1356 N-mm	1 m = .0000394 in	1 N-mm = .000737 ft-lb
1 in = 25.4 mm	1 ft-lb = .1383 kgf-m	1 mm = .03937 in	1 kgf-m = 723 ft-lb
1 in = .0254 m	1 in-lb = .000113 kN-m	1 m = 39.37 in	1 kN-m = 88472 in-lb
1 in = .0000254 km	1 in-lb = .113 N-m	1 km = 39370 in	1 N-m = 8.847 ft-lb
	1 in-lb = .01152 kgf-m		1 kgf-m = 86.8 in-lb
Weight/Force		Weight/Force	
1 lb = .454 kg		1 kg = 2.205 lb	
1 lb = .454 kgf		1 kgf = 2.205 lb	
1 lb = 4.45 N		1 N = .225 lb	
1 lb = .00445 kN		1 kN = 224.8 lb	
Speed		Speed	
1 ft/sec = .3048 m/sec		1 m/sec = 3.28 ft/sec	
1 in/sec = .0254 m/sec		1 m/sec = 39.37 in/sec	



Also find us at:



Nook_Screw_Jacks_CTEN-0012-01 | 20220714KB
Specifications are subject to change without notice. It is the responsibility of the product user to determine the suitability of this product for a specific application. All trademarks property of their respective owners. ©2022 Thomson Industries, Inc.

4950 East 49th Street | Cleveland, OH 44125-1016 USA | 216.271.7900 | toll-free: 800.321.7800 | f: 216.271.7020 | email: nook@nookind.com